



FieldLogger

INSTRUCTION MANUAL

V1.5x

INTRODUCTION.....	3
CONNECTIONS AND INSTALLATION.....	4
MECHANICAL INSTALLATION.....	4
ATTACHING AND DETACHING THE FRONT COVER	8
ATTACHING AND DETACHING THE HMI.....	9
ELECTRICAL CONNECTIONS.....	9
SAFETY SUMMARY	9
RECOMMENDATIONS FOR INSTALLATION.....	10
POWER SUPPLY	11
DIGITAL I/O	11
RELAYS.....	11
RS485.....	11
AUXILIARY POWER SUPPLY FOR POWERING TRANSMITTERS	12
ANALOG INPUTS.....	13
CONNECTIVITY RESOURCES	14
FLAGS (LEDS).....	15
INSTALLING THE USB DRIVER	16
WINDOWS 7	16
DEFINITION AND SELECTION OF SERIAL PORT (COM) - WINDOWS.....	20
CONFIGURATION AND DATA DOWNLOAD SOFTWARE.....	21
CONFIGURATION	22
GENERAL CONFIGURATIONS	24
RS485 INTERFACE CONFIGURATION.....	25
ETHERNET INTERFACE CONFIGURATION	26
ETHERNET INTERFACE CONFIGURATION - TCP/IP	27
ETHERNET INTERFACE CONFIGURATION – FTP	28
ETHERNET INTERFACE CONFIGURATION - SMTP.....	30
ETHERNET INTERFACE CONFIGURATION - E-MAIL RECEIVERS.....	30
ETHERNET INTERFACE CONFIGURATION - SNMP	31
ETHERNET INTERFACE CONFIGURATION – HTTP	32
ETHERNET INTERFACE CONFIGURATION – MODBUS TCP	33
ETHERNET INTERFACE CONFIGURATION – CLOUD	34
ANALOG CHANNELS CONFIGURATION.....	35
ANALOG CHANNELS CONFIGURATION – CUSTOM CALIBRATION.....	37
DIGITAL CHANNELS CONFIGURATION.....	38
REMOTE CHANNELS CONFIGURATION	40
VIRTUAL CHANNELS CONFIGURATION	43
ALARMS CONFIGURATION	44
LOGS CONFIGURATION	48
DIAGNOSTICS.....	50
DOWNLOAD	53
DOWNLOAD DATA	54
DOWNLOAD MANAGER.....	56
USING STEP-BY-STEP (WIZARD).....	57
NON STEP-BY-STEP	64
PREFERENCES.....	68
PASSWORD PROTECTION.....	68
COMMAND-LINE OPERATION	69
BATCH FILE	69
ACTION TYPE	69
CONNECTION MODE	69

ACTION PARAMETERS	70
EXPORT PARAMETERS	70
<i>FIELDLOGGER</i> OPERATION	71
ANALOG INPUTS	71
DIGITAL INPUTS/OUTPUTS	72
COUNTINGS	73
OUTPUT RELAYS.....	73
RS485 INTERFACE	73
AUXILIARY RS485	73
REMOTE CHANNELS.....	74
VIRTUAL CHANNELS.....	74
USB INTERFACE.....	76
USB DEVICE	76
USB HOST.....	76
ETHERNET INTERFACE	77
MODBUS-TCP	77
SENDING E-MAILS - SMTP	77
WEB PAGES - HTTP	78
UNCHANGEABLE PAGES	78
CUSTOM PAGES	81
FILE TRANSFER - FTP	83
NETWORK MANAGEMENT - SNMP	84
CLOUD	85
OPERATION	85
AUTHENTICATION AND OTHER DETAILS.....	85
DATA LOGGING AND DOWNLOAD.....	86
ALARMS.....	89
DATA COMMUNICATION.....	90
<i>HMI</i> (HUMAN-MACHINE INTERFACE)	91
“FAVORITES” SCREEN	93
“CHART” SCREEN.....	93
“CHANNEL LIST” SCREEN.....	93
“ALARMS” SCREEN	93
“STATUS” SCREEN	94
“CONFIGURATION” SCREEN	94
EQUIPMENT SOFTWARE (FIRMWARE) UPDATE	96
CLOCK BATTERY REPLACEMENT.....	99
SPECIFICATIONS	101
SAFETY INFORMATION	103
SUPPORT AND MAINTENANCE	103
LIMITED WARRANTY AND LIMITATION OF LIABILITY.....	103

INTRODUCTION

The **FieldLogger** is a high-resolution and high-speed data acquisition and logging equipment for analog and digital signals. The result of an advanced technological development, the product is distinguished in diverse aspects, such as high-performance, high-connectivity and ease of configuration and operation. This technology is presented as the ideal solution for applications that require flexibility and functionality for diverse communication networks.

Its main features include:

- Analog inputs: 8
- Digital inputs/outputs: 8
- Relay outputs: 2
- 2 MB internal memory
- SD Card interface (up to 16 GB – not available in some models)
- RS485 interface
 - Main: Modbus RTU master and slave
 - Auxiliary (DB9 connector – not available in some models): Modbus RTU slave
- Ethernet services (not available in some models):
 - DHCP
 - HTTP (web page)
 - FTP (client and server)
 - SMTP (e-mails sending)
 - SNMP
 - Modbus TCP
- USB:
 - Host
 - Device
- HMI (human-machine interface – optional)

There are four input channel types in the **FieldLogger**: analog, digital, remote and virtual. Analog and digital channels are those acquired directly by **FieldLogger** through their respective inputs. The remote channels are those acquired through Modbus RTU protocol, operating as master on its RS485 interface. Virtual channels are a special type of input channel where mathematical operations can be carried out, allowing the calculation of complex formulas from the measured information.

The analog input channels are configurable for reading voltage, current, thermocouples, Pt100 and Pt1000 signals. These inputs count on the precision of a 24 bit A/D converter with high acquisition speed, which can reach 1000 samples per second. The digital channels can be configured individually as inputs or outputs.

The Ethernet interface allows data download and data access of the inputs and outputs, through services that can be individually enabled and configured. Through a web browser (HTTP), one can visualize the data of the enabled channel, diagnostics and general information of the **FieldLogger**. FTP client can be used for logging data downloads. **FieldLogger** can identify up to 32 distinct alarm conditions, allowing the triggering of outputs, sending e-mails or SNMP traps whenever an alarm condition is detected. All the information relative to the variables, status and diagnostics of the **FieldLogger** are available in Modbus registers that can be accessed through the Modbus TCP interface or the Modbus RTU interface available either through USB interface (device) or RS485 (when operating as slave).

The USB Interface *device* is used for connection to a computer for configuration, monitoring or download. Whereas the USB interface *host* is used for connection of a USB flash drive, for data downloading from the logging memory.

The data logging memory can be transferred by any of the interfaces to the configuration software, which allows the exportation for the most diverse data formats.

When the indication of the measured data from the process is necessary, an exclusive color graphical display HMI (Human-Machine Interface) can be attached or installed remotely (optional).

CONNECTIONS AND INSTALLATION



When unpacking, **remove** the insulating film of the *FieldLogger* battery, located below the chassis according to **Fig. 01**, before carrying through the electrical wiring and configuration.

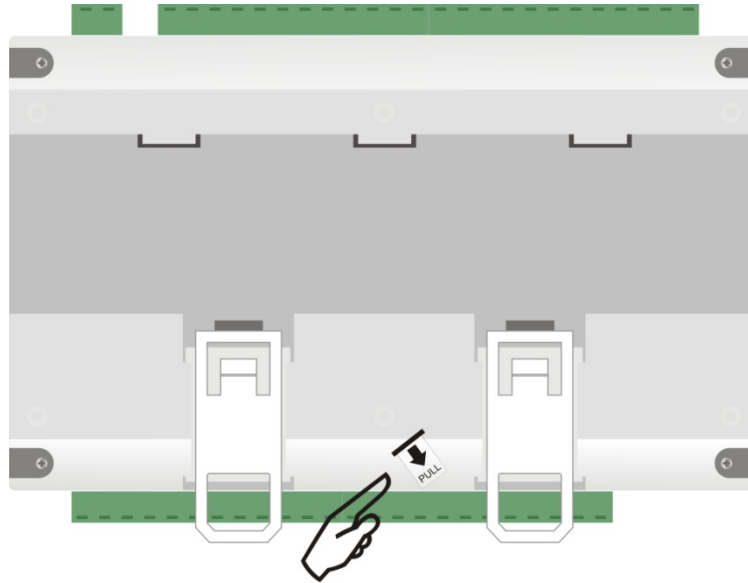


Fig. 01 – Insulating film of the battery

MECHANICAL INSTALLATION

FieldLogger chassis can be installed on a 35 mm DIN rail.

For the installation on the rail, you must pull out the two clamps located right below the connections of the channels, taking care not to remove them, as per **Fig. 02**.

Note: If necessary, the connector may be removed for installation of DIN rail.

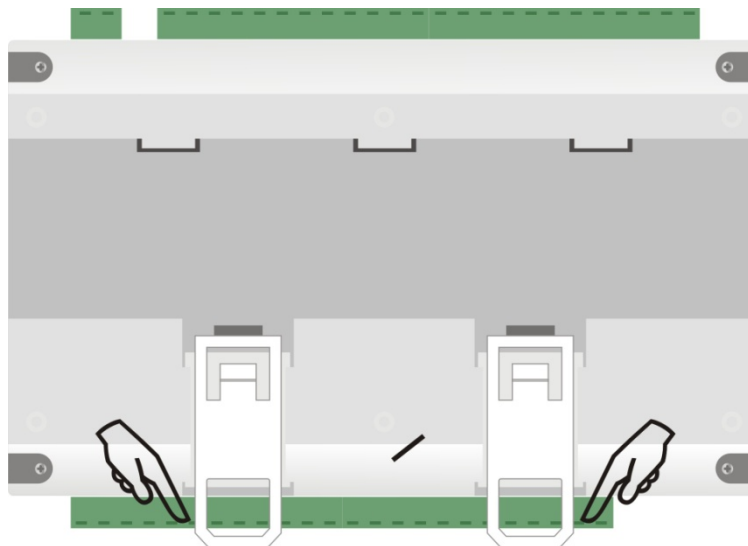


Fig. 02 - DIN rail installation

Afterwards, fit the **FieldLogger** to the rail according to **Fig. 03**.

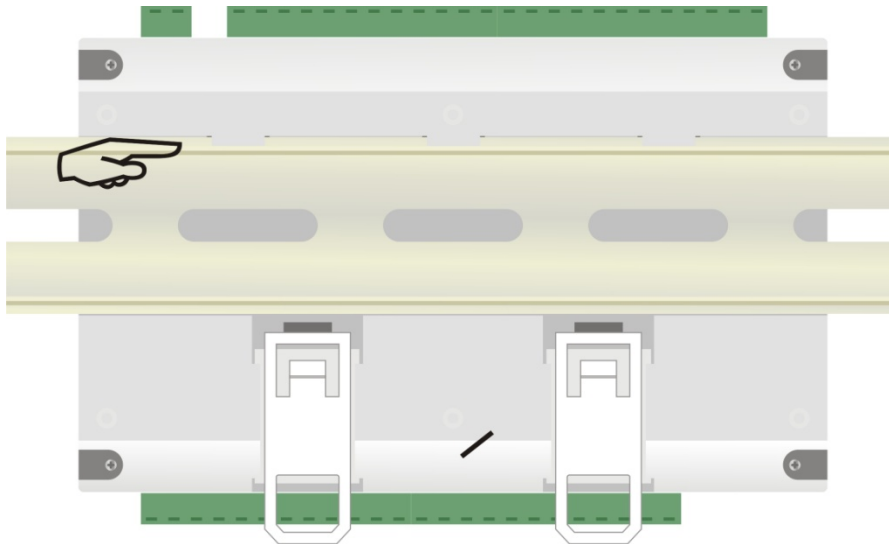


Fig. 03 - DIN rail installation

And finally, push the two clamps until you hear a double click for the complete installation, as per **Fig. 04**.

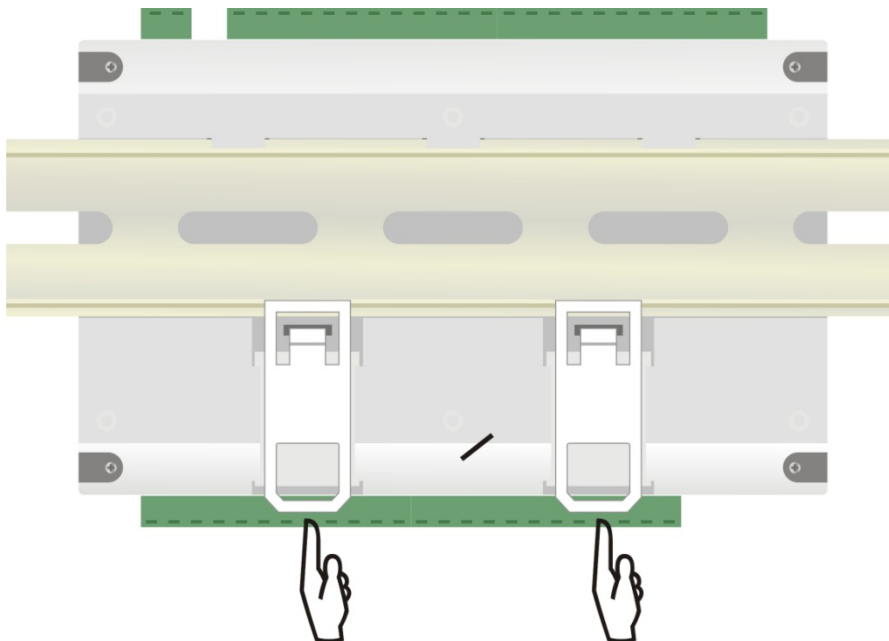


Fig. 04 - DIN rail installation

Dimensions:

- Without HMI module:

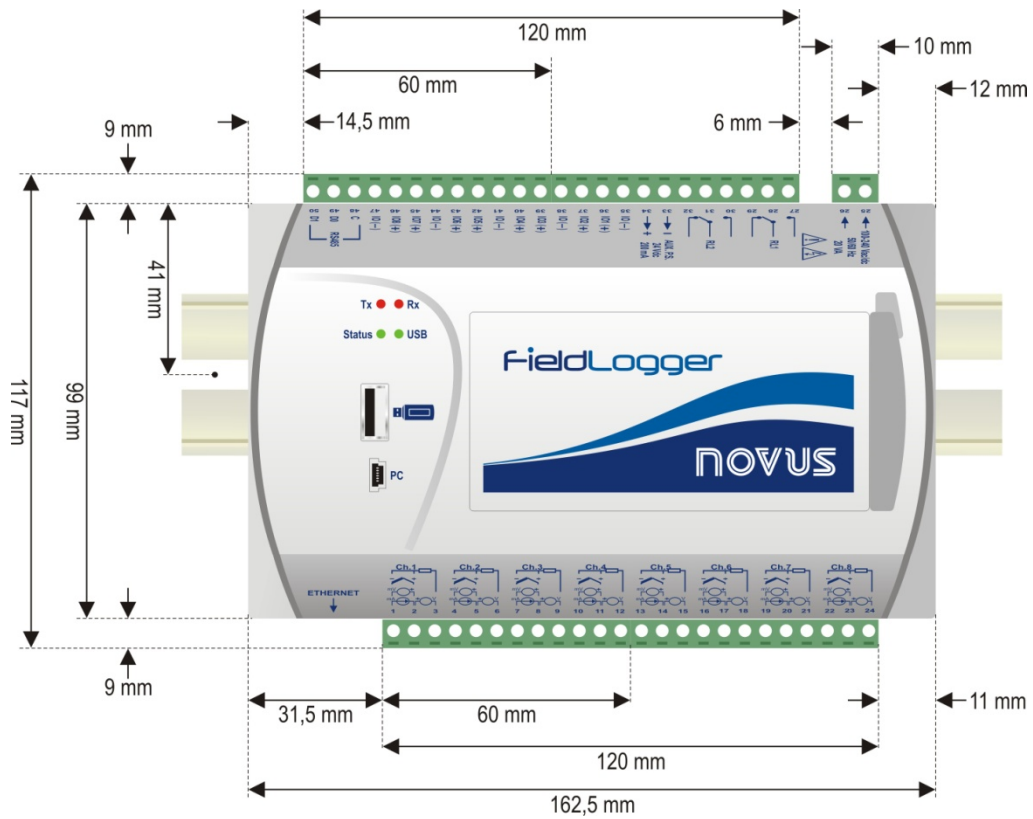


Fig. 05 – Dimensions of the *FieldLogger* without HMI module

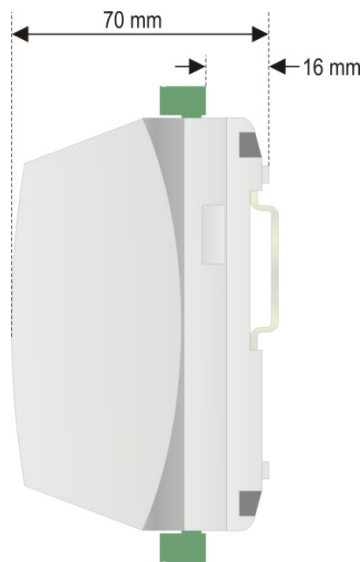


Fig. 06 – Dimensions of *FieldLogger* side without HMI module

- With HMI module (Optional):

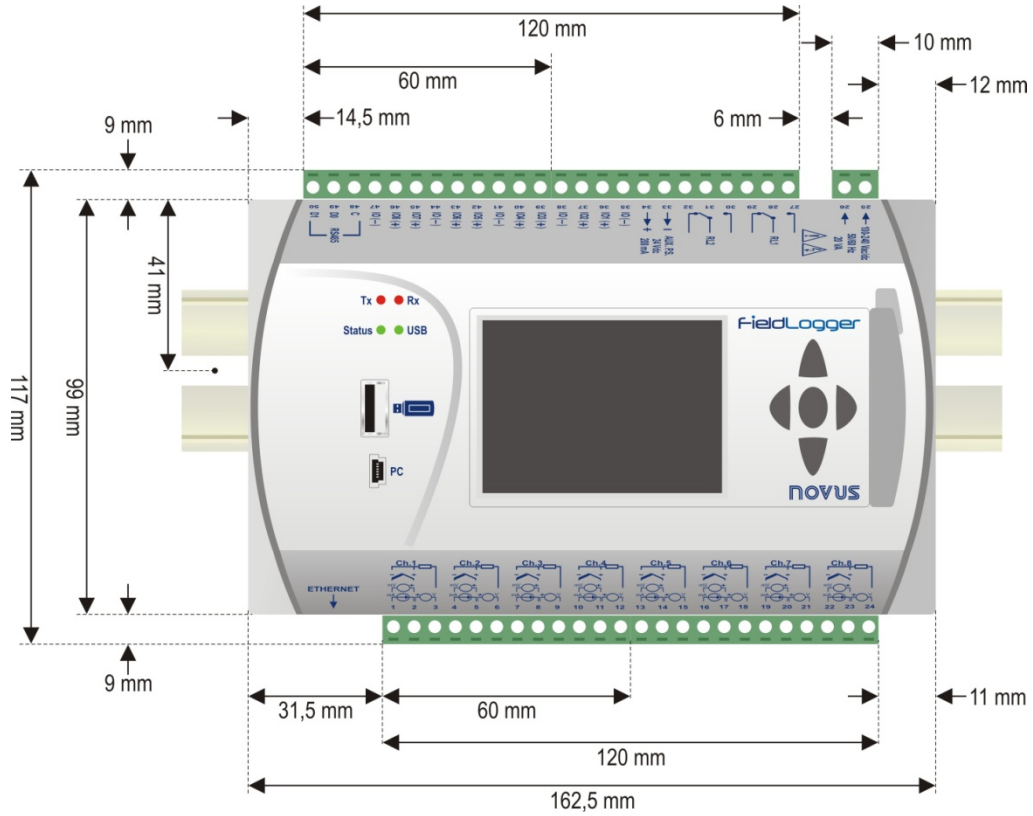


Fig. 07 – Dimensions of the *FieldLogger* with HMI module

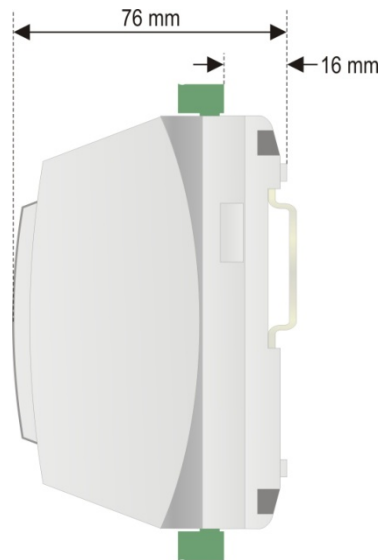


Fig. 08 – Dimensions of *FieldLogger* side with HMI module

ATTACHING AND DETACHING THE FRONT COVER

When detaching the front cover, pull the lever at the right side of the **FieldLogger** up to the end.

When attaching it, insert the cover (left side first) and press its right side gently. After that, press the lever back into the chassis.

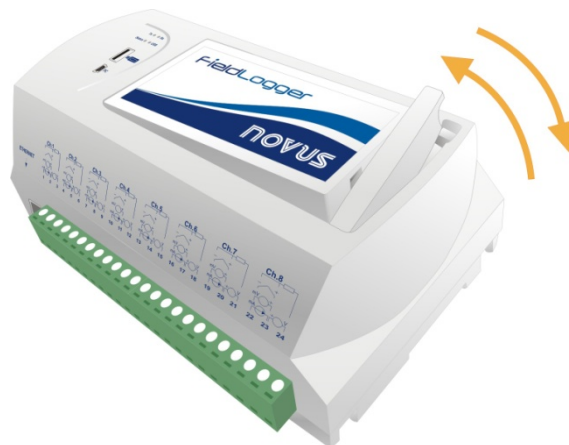


Fig. 09 – Attaching and detaching **FieldLogger** front cover

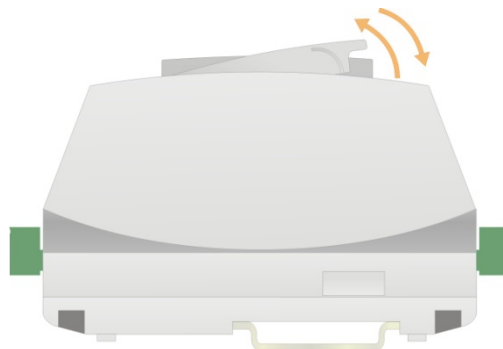


Fig. 10 – Attaching and detaching **FieldLogger** front cover (side view)

ATTACHING AND DETACHING THE HMI

When detaching the **HMI**, pull up the lever at the right side of the **FieldLogger** up to the end.

When attaching it, insert the **HMI** (left side first) and press its right side until DB9 connectors are firmly connected. After that, press the lever down into the chassis.



Fig. 11 – Attaching and detaching **FieldLogger HMI**

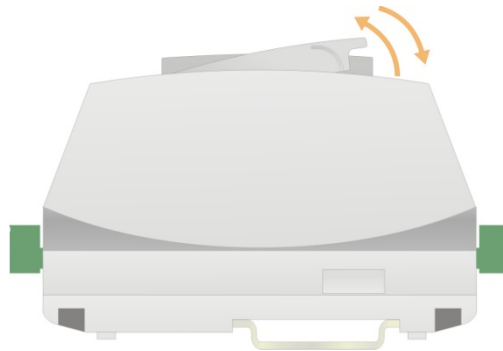






Fig. 12 – Attaching and detaching **FieldLogger HMI** (side view)

ELECTRICAL CONNECTIONS

SAFETY SUMMARY

The symbols below are used on the equipment and throughout this document to draw the user’s attention to important operational and safety information.

			
<p>CAUTION or WARNING: Read complete instructions prior to installation and operation of the unit.</p>	<p>CAUTION or WARNING: Electrical Shock Hazard</p>	<p>DOUBLE INSULATION The FieldLogger power supply is double insulated, represented by the above symbol printed on the equipment’s connection label.</p>	<p>POWER INPUT The FieldLogger may be powered from either AC or DC power source.</p>

All safety related instructions that appear in the manual must be observed to ensure personal safety and to prevent damage to either the instrument or the system. *If the instrument is used in a manner not specified by the manufacturer, the protection provided by the equipment may be impaired.*

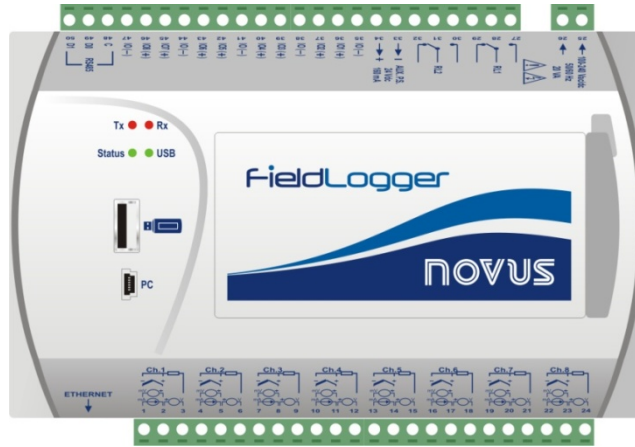


Fig. 13 - FieldLogger front panel

FieldLogger has two rows of terminals for diverse connections; among them are the following items: Ethernet, input connections, power supply, output relays, auxiliary power supply output, digital inputs and serial communication. This information is identified in the box of FieldLogger according to Fig. 14 and Fig. 15:

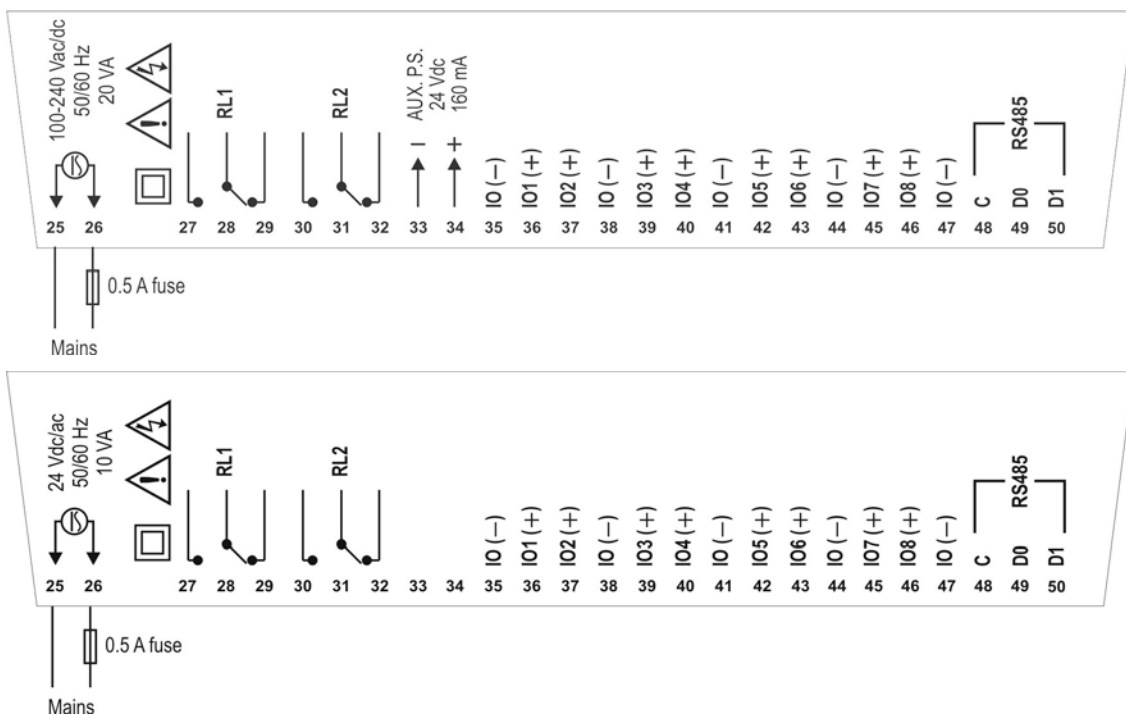


Fig. 14 - Upper side connections for standard and 24 V models

- NOTES:
- 1) An external protection device consisting of a 0.5 A slow blow fuse (UL Listed) must be wired near to the FieldLogger.
 - 2) A switch or circuit-breaker placed near to the FieldLogger shall be used as the disconnecting device.

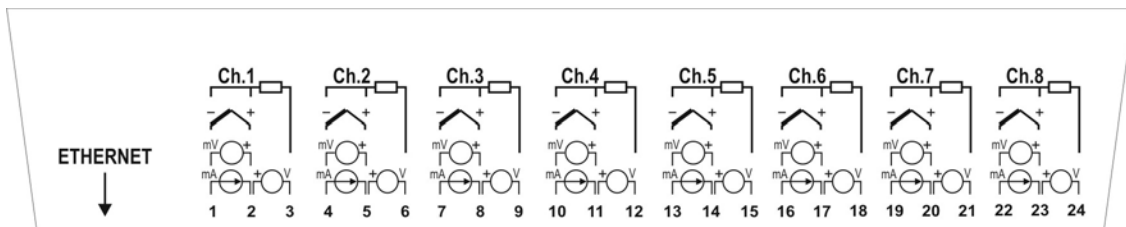


Fig. 15 - Lower side connections

RECOMMENDATIONS FOR INSTALLATION

- Input signal leads must be installed in grounded conduits and away from power or contactor wires.
- Instruments must be powered only by an exclusive power supply.
- Installing RC filters (47 Ω and 100 nF, serial) is strongly recommended at contactor coils or any other inductors.
- System failure should always be taken into account when designing a control panel to avoid irreversible damage to equipment or injury to people. The RL1 and RL2 output relays, used as alarms, do not warrant total protection.
- Wires section: minimum gauge 0.14 mm².

POWER SUPPLY

The terminals 25 and 26 indicate the main power supply of *FieldLogger*.

DIGITAL I/O

There are eight I/O that can be individually configured as inputs or outputs. There is a terminal for the positive signal of each I/O, but the negative terminal of all of them is common (there is no isolation among the channels).

- Inputs:

When configured as inputs, they may be connected to voltage outputs (please check the acceptable levels in the *Specifications* section), dry-contact outputs and NPN outputs. Care must be taken when connecting multiple outputs because of the lack of isolation between the *FieldLogger* inputs.

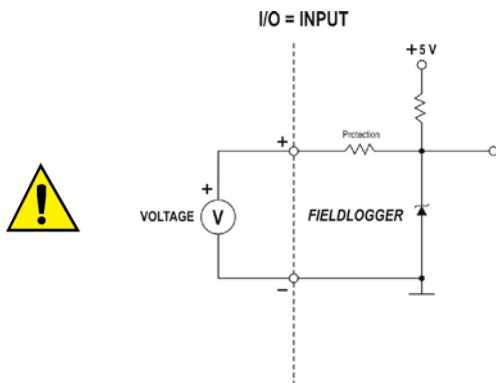


Fig. 16 - Voltage connection

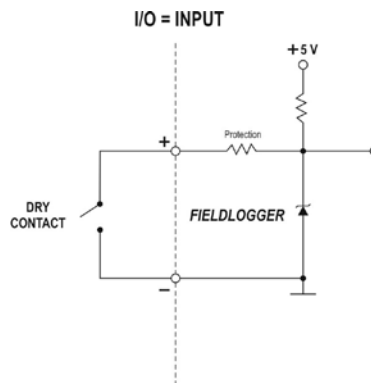


Fig. 17 - Dry-contact connection

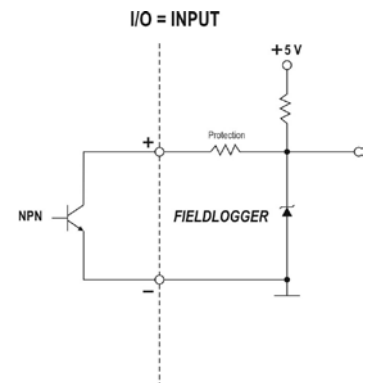


Fig. 18 - NPN Connection

- Outputs:

When configured as outputs, they can activate limited power loads (please check the *Specifications* section).

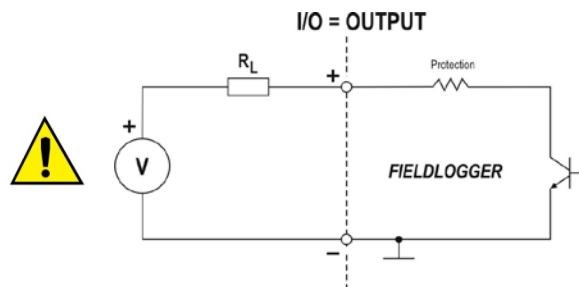


Fig. 19 - Connection of a load R_L to a digital output

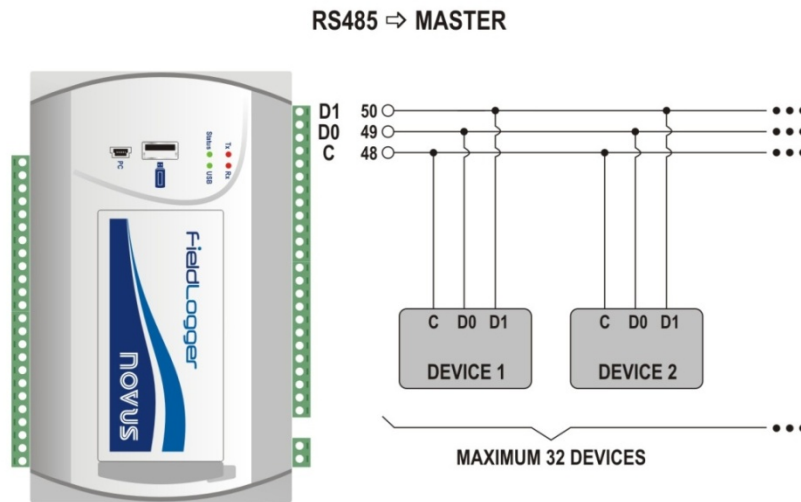
RELAYS

FieldLogger has 2 relays that can be used in the activation of electrical loads (please check the *Specifications* section). For each relay, we have the common terminal, NC (normally closed) terminal and the NO (normally open) terminal. When deactivated, the relay common is in contact with the NC terminal. When activated, the common is in contact with the NO terminal.

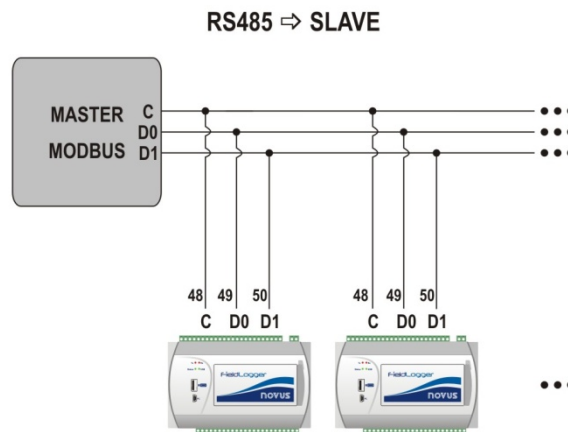
RS485

The RS485 Interface of the *FieldLogger* has terminals for the 3-wire communication, including the common. The connection in a Modbus network will depend if the device is configured to operate as a master or a slave.

- Master



- Slave



AUXILIARY POWER SUPPLY FOR POWERING TRANSMITTERS

For non 24 V models, there is a 24 Vdc power supply available in the **FieldLogger** for powering transmitters in the field. This auxiliary power supply is electrically isolated from the other **FieldLogger** terminals.

Below is the correct way to use the auxiliary power supply for powering 4-20 mA transmitters (2-wire).

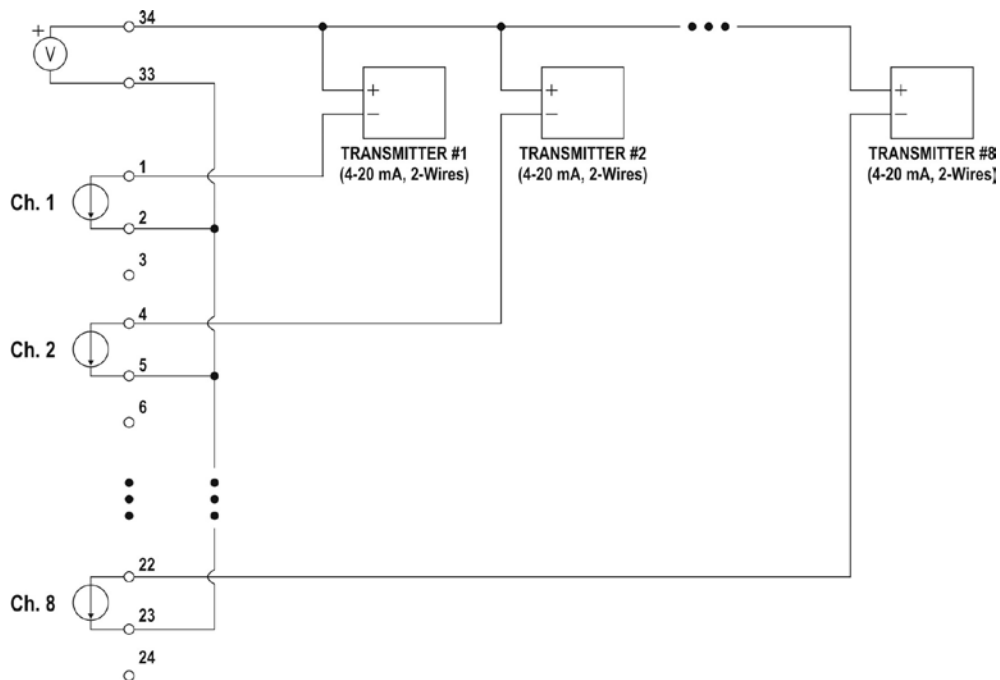
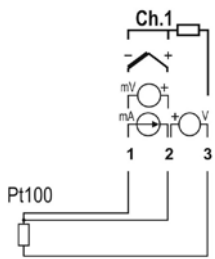


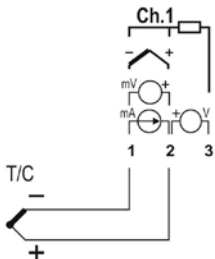
Fig. 20 – Auxiliary power supply powering 4-20 mA (2-wire) transmitters

ANALOG INPUTS

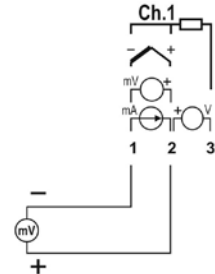
Pt100/Pt1000 connection

	<p>The connection for the channels is made to the terminals in accordance with the figure at the left. The 3-wire connection from the Pt100 sensing element to the FieldLogger input guarantees the cancellation of the error caused by the resistance of the wires. All three wires must have the same gauge and length.</p> <p>For the two-wire Pt100, interconnect terminals 1 and 2.</p>
---	---

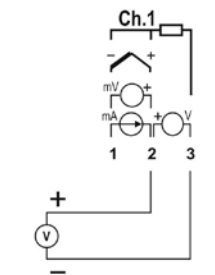
Thermocouple connection

	<p>The connection for the channels is made in the terminals in accordance with the figure at the left. Please observe the correct connection polarity.</p> <p>Cables used for connecting thermocouples must have the same thermoelectric characteristics of the used thermocouple (compensation cable or extension cable), and also must be connected with the correct polarity.</p> <p>The non-use of compensation cables or the use with the incorrect polarity can cause significant measurement errors.</p>
---	---

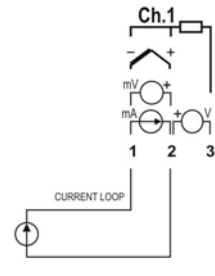
Voltage (mV) connection

	<p>The connection for the channels is made in the terminals in accordance with the figure at the left. Please observe the correct polarity of the connection.</p>
--	---

Voltage (V) connection

	<p>The connection for the channels is made in the terminals in accordance with the figure at the left. Please observe the correct polarity of the connection.</p>
---	---

Current (mA) connection

	<p>The connection for the channels is made in the terminals in accordance with the figure at the left. Please observe the correct polarity of the connection.</p>
---	---

CONNECTIVITY RESOURCES

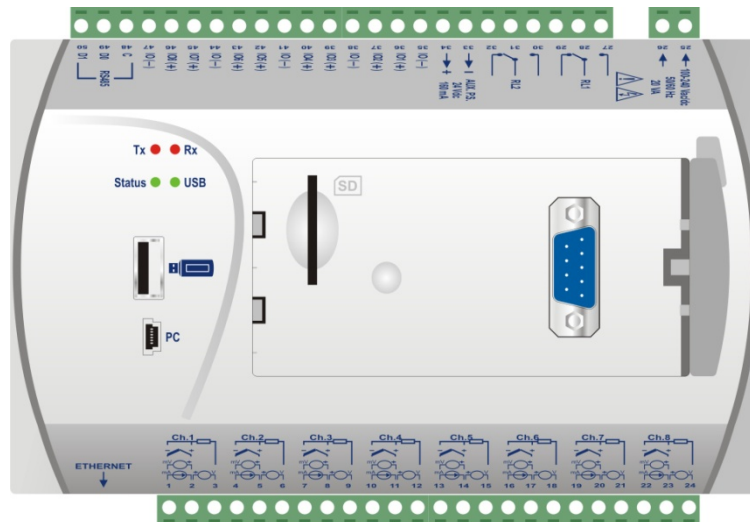


Fig. 21 - *FieldLogger* connectivity resources

USB Connection

	<p>Interface used for a <i>USB drive</i> connection, for downloading data from the logging memory.</p>
--	--

PC Connection

	<p>Interface used for connection to a computer for configuration, monitoring or data download.</p>
--	--

SD card connection

	<p>Interface used for SD card expansion. The data from the logging memory can be transferred by any of the interfaces to the configuration software, which allows the exportation for the most diverse data formats.</p>
--	--

Ethernet

	<p>Interface used for Ethernet 10/100 communication. It is recommended to use a category 5 (or better) cable in a RJ45 connector.</p> <p>The Ethernet connector of the <i>FieldLogger</i> has two LEDs for luminous indication: the green LED (on the left side) lights indicating the connection to the Ethernet network; the yellow LED (on the right side) flashes indicating that there is data traffic in the interface.</p>
--	---

DB9 connection for HMI (Optional)

	<p>Connection for installation of HMI (Human–Machine Interface) of the <i>FieldLogger</i> for indication of signals measured in the process. From firmware version 1.20 on, it can be used as a generic RS485/Modbus RTU (slave) port.</p>
--	--

FLAGS (LEDS)

Tx/Rx flags

Tx ● ● Rx	They signal transmission and reception of data by the RS485/Modbus interface, regardless if it is configured to operate in master or slave mode.
-----------	--

Status / USB flags

Status ● ● USB	<p>When connecting the equipment, both LEDs flash two times and remain off until all the initialization has been completed.</p> <p>The Status flag remains ON in normal condition. When it is logging, flashes 2 times at 3 second intervals. In error cases, this LED will be flashing 3 times at 8 second intervals.</p> <p>In the error cases, please check if the clock of the FieldLogger has the correct date and time. If they are wrong, probably the battery of the clock has run low and needs to be replaced. If it is OK, try rebooting the machine by turning off its power supply and restarting it after 10 seconds. If the LED continues to indicate an error, there may be something wrong with your FieldLogger.</p> <p>The USB flag remains ON only while a cable is connected in the USB device or while the USB flash drive is plugged into the USB host interface. The following exceptions are:</p> <ul style="list-style-type: none"> • Download errors via USB flash drive: flash drive with insufficient writing space, inability to write in the flash drive (write protected) or flash drive not compatible (sector different from 512 bytes, for example), the USB LED flashes while the error condition remains (typically, until the flash drive has been removed). Check the "USB Interface" section in the chapter "FieldLogger Operation" for more details. • At the end of the download, if everything is correct, the USB flag remains ON until the flash drive has been removed from the equipment.
----------------	--

INSTALLING THE USB DRIVER

When installing the configuration software, the USB driver is automatically installed. If you need to install the driver without depending on the software, this can be done by following the procedure described below.



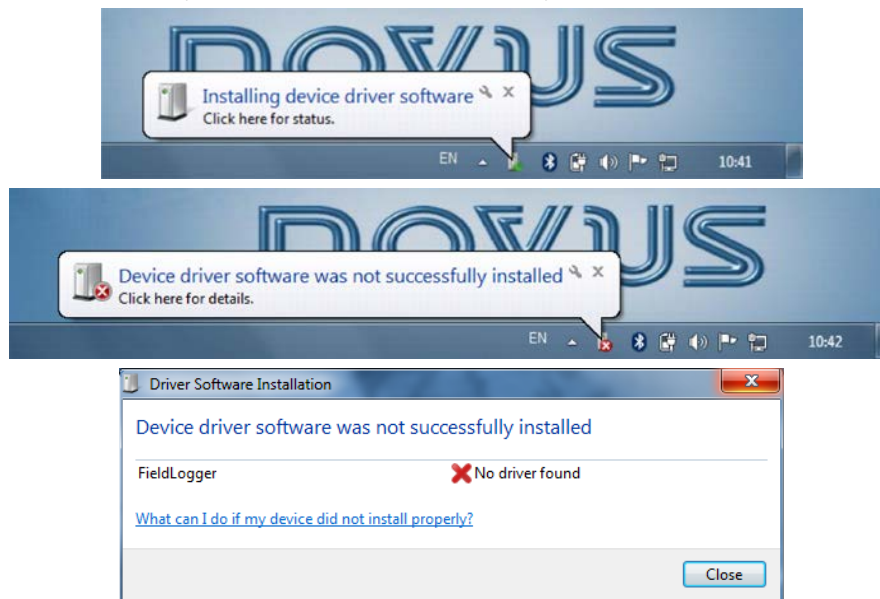
Windows 8 (64 bits) does not allow the installation of drivers that are not "digitally signed" by Microsoft. Thus, before installing the USB drivers of the **FieldLogger**, the following script should be followed:

1. During the boot, you should press the F8 key to enter the Start-up Configurations.
2. Pressing the F7 key, you can disable the Imposition of the Driver Signature.
3. Windows 8 will now allow you to install the USB driver for **FieldLogger**.

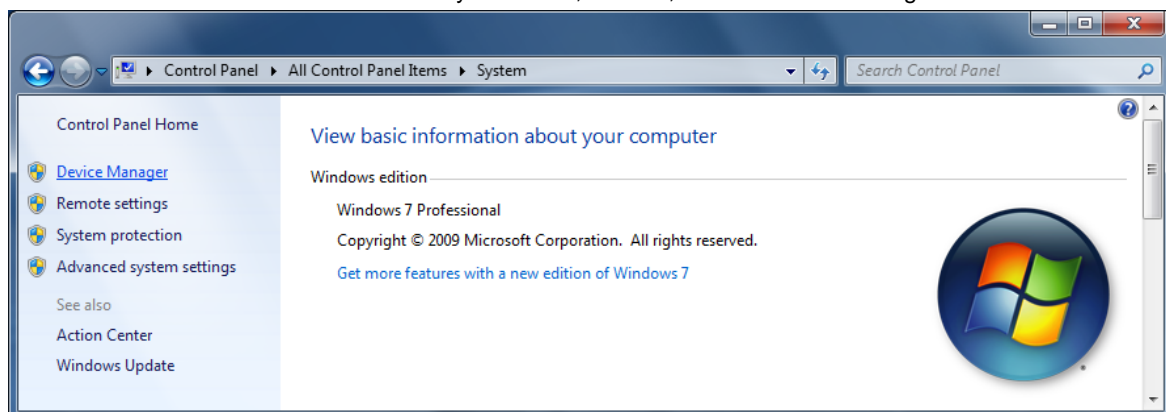
The following installation steps may vary from PC to PC, even for the same operating system version. The steps and screens that follow below are only for guidance purposes.

WINDOWS 7

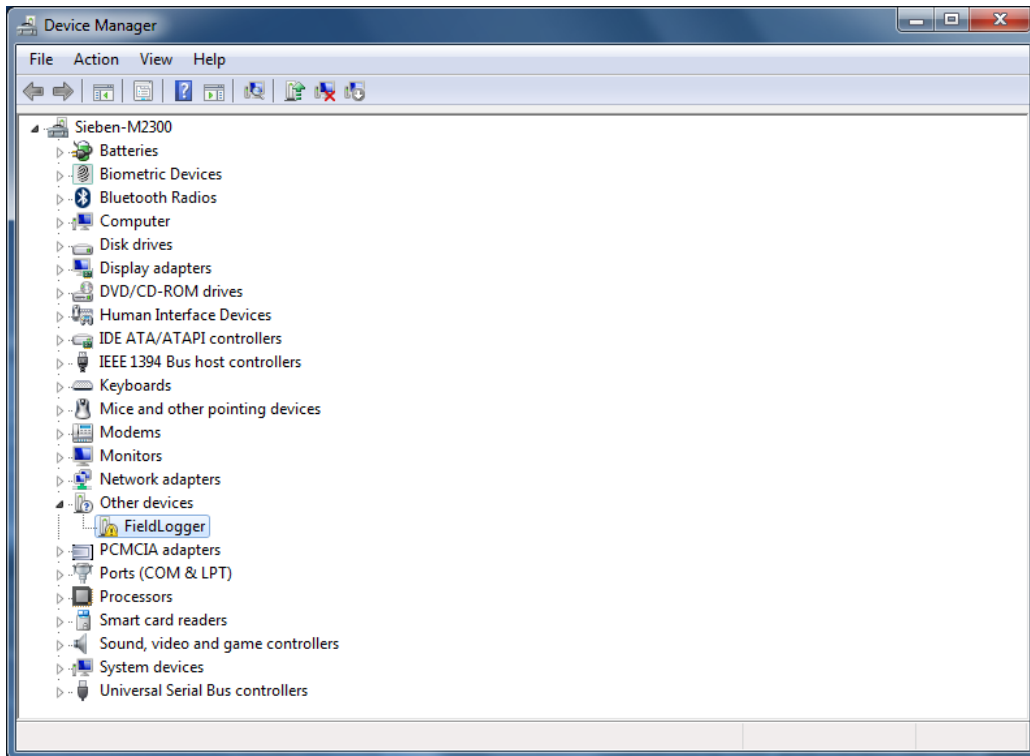
1. Connect **FieldLogger** in a USB port on your computer. Windows will try to install a driver automatically and will not succeed, because the necessary driver is not in its standard library.



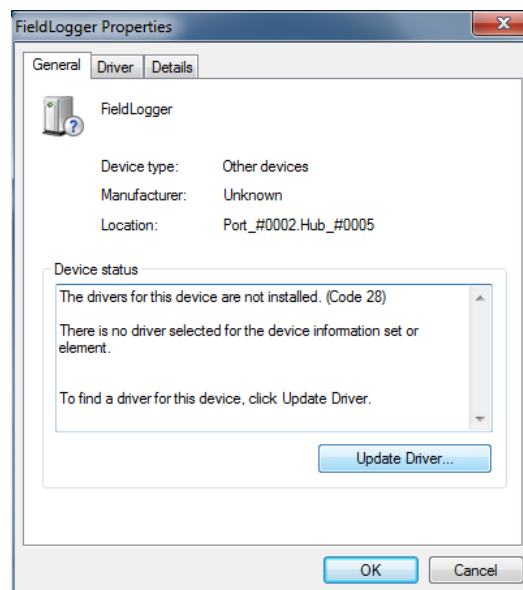
2. Click on "Start>> Control Panel". Click on "System" and, later on, on the "Device Manager".



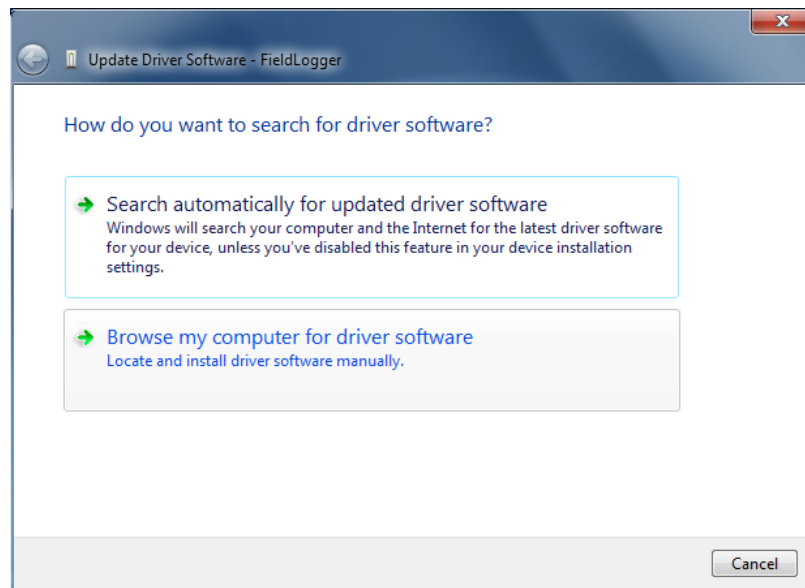
3. Locate the **FieldLogger** (probably with an icon with an exclamation mark next to it) and double-click on it.



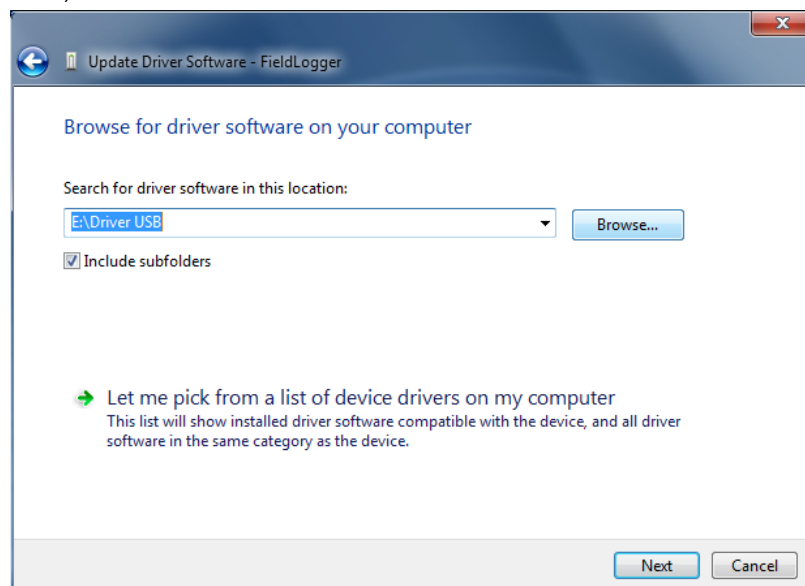
4. Click on the button "Update Driver...".



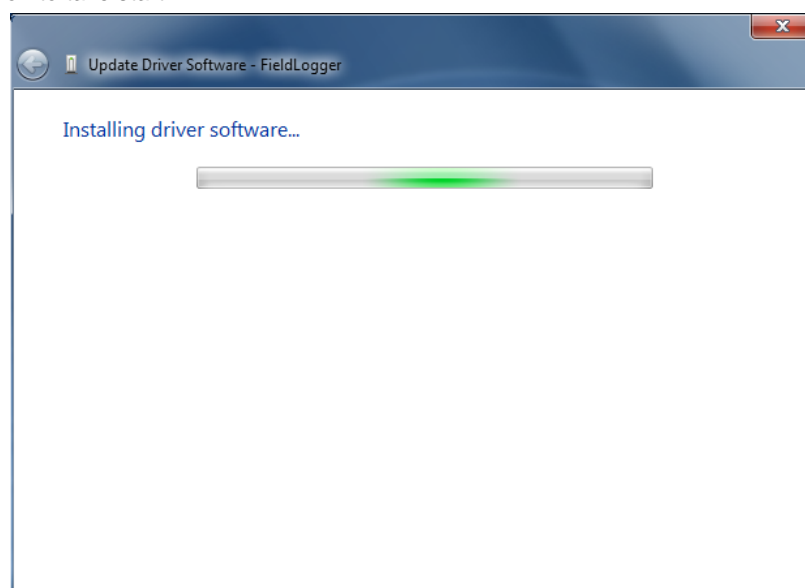
5. Ask to "Browse my computer for driver software".



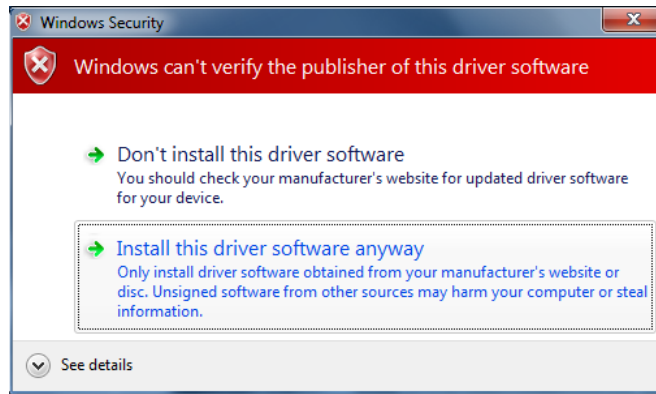
6. Enter the path of the folder where the drivers are located (the product CD or folder where you saved them when downloaded from the site.)



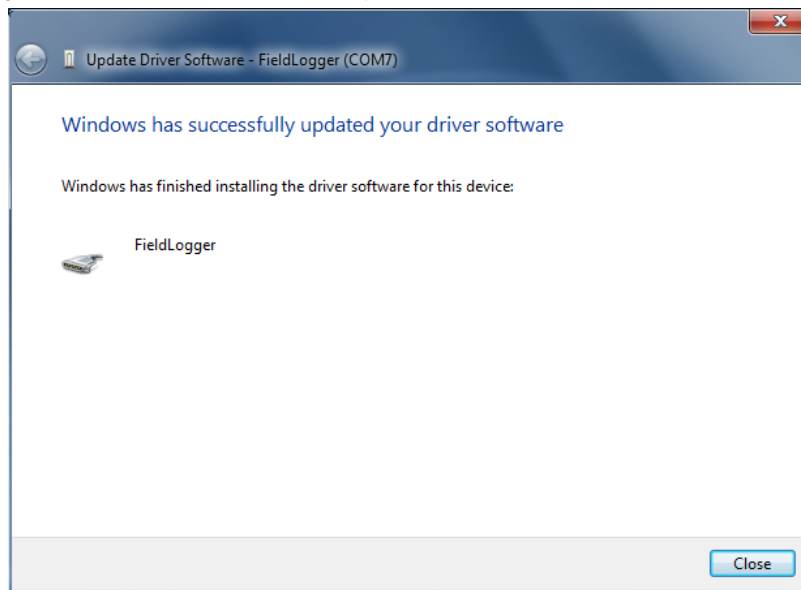
7. Wait for the installation to take start.



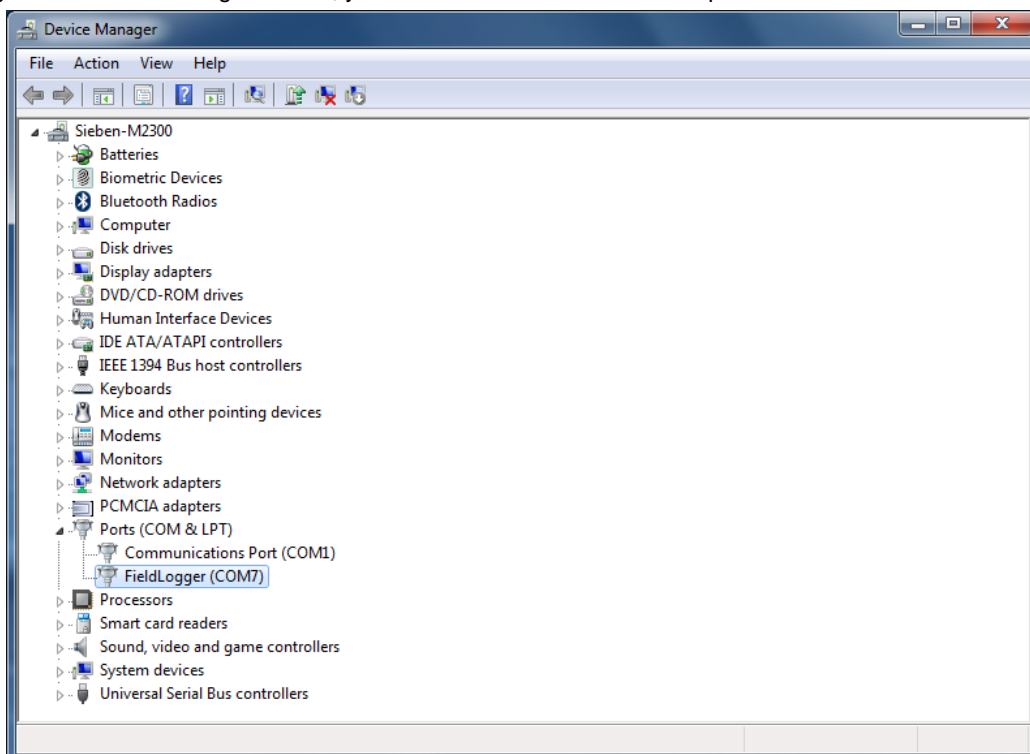
8. Windows will indicate that it cannot verify the editor of this driver. Confirm to install anyway!



9. A message indicating successful installation will display.



10. Returning to the Device Manager screen, you can check which virtual serial port is allocated to the **FieldLogger**.



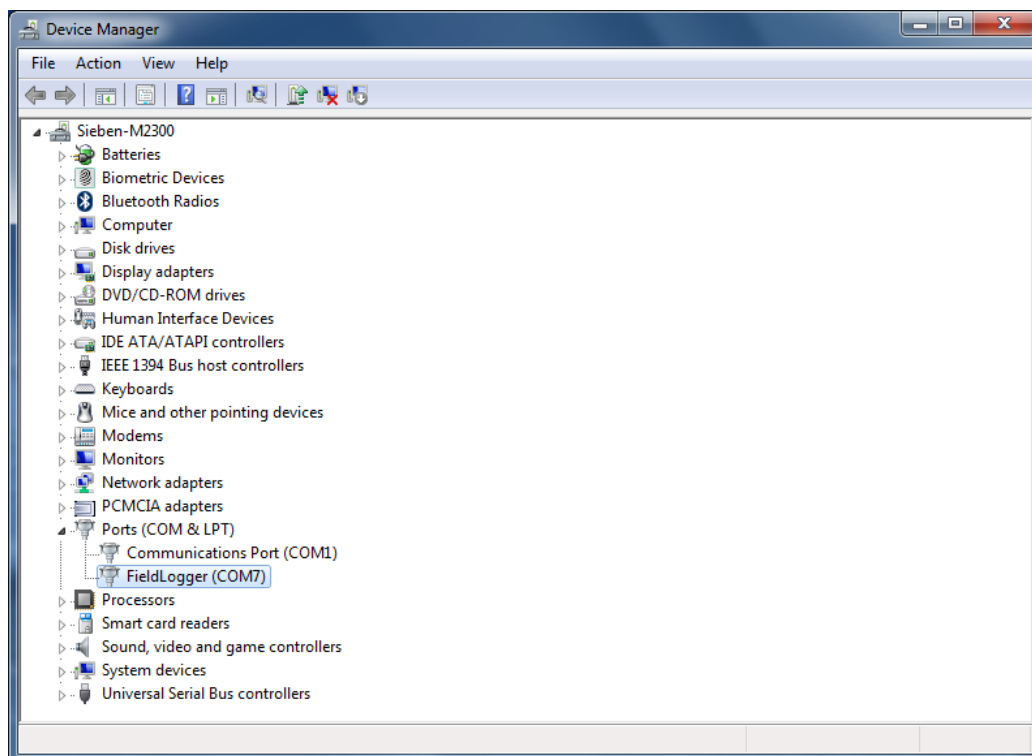
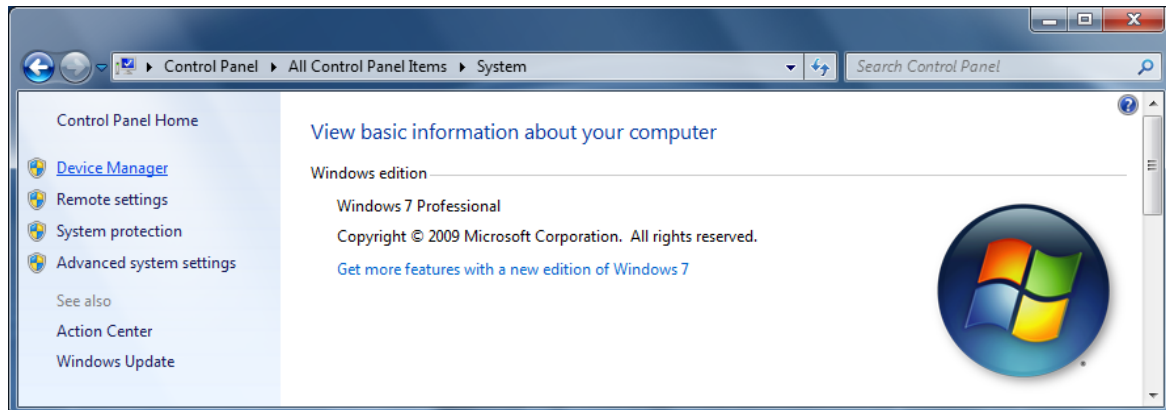
DEFINITION AND SELECTION OF SERIAL PORT (COM) - WINDOWS

The serial port associated with **FieldLogger** is automatically defined by the operating system a few moments after connecting the **FieldLogger**. The user can easily identify or change the COM port associated with **FieldLogger**.

Control Panel / System / Hardware / Device Manager / COM & LPT Ports

Select the device "USB Serial Port" corresponding to the **FieldLogger** and click on "Properties". Select "Port Settings" guide and click on "Advanced". In the "COM Port Number", select the serial port to be associated with **FieldLogger**. Some serial ports can be checked while being used (In Use). Just select one of these ports if you know that it is not being used by another peripheral device on your computer.

In some cases, the serial ports can be checked as in use even when the associated device is no longer installed on your computer. In this case it is safe to associate this port to **FieldLogger**. The following figure presents the view of the device manager containing a **FieldLogger**, and the screens showing the property screens where you can reset the associated COM port.

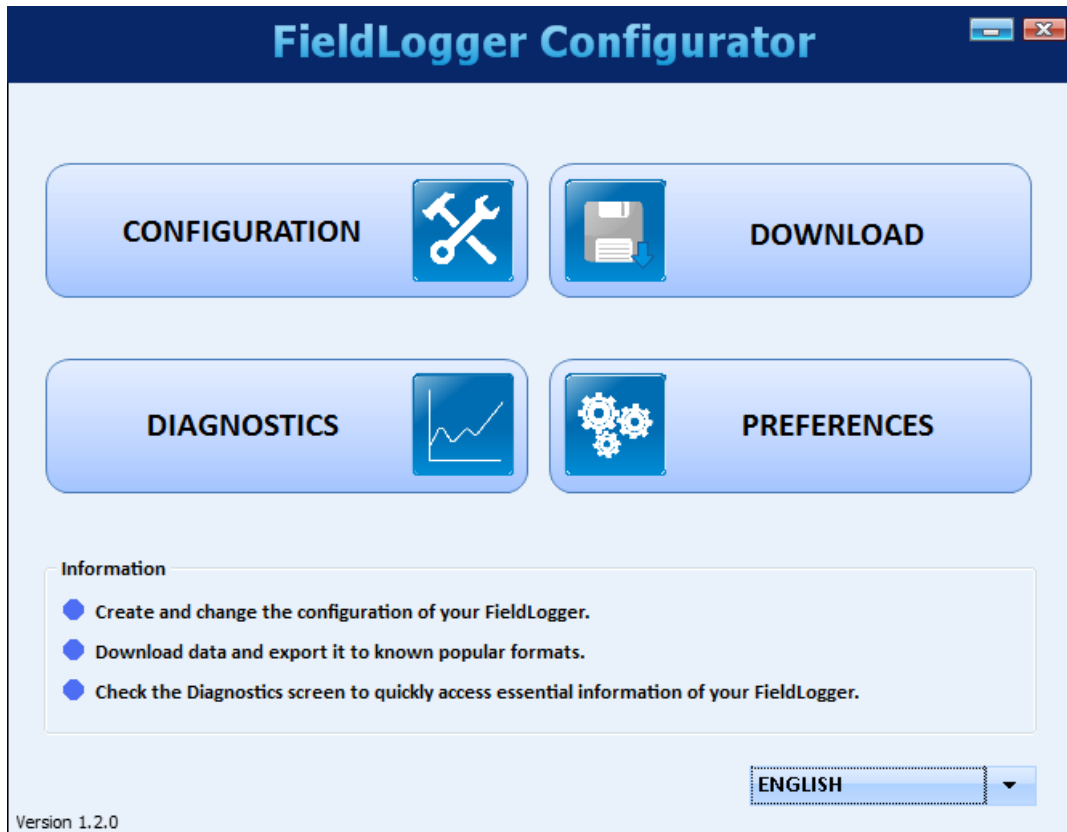


CONFIGURATION AND DATA DOWNLOAD SOFTWARE

The configuration software (Configurator) allows you to configure **FieldLogger**, download and export logging data and read input channels and status information. This chapter is intended to show and explain software usage. The use of **FieldLogger** with all its features will be detailed in the chapter "**FieldLogger** Operation".

On the main screen, you should choose the function that you want to run, as it is shown below:

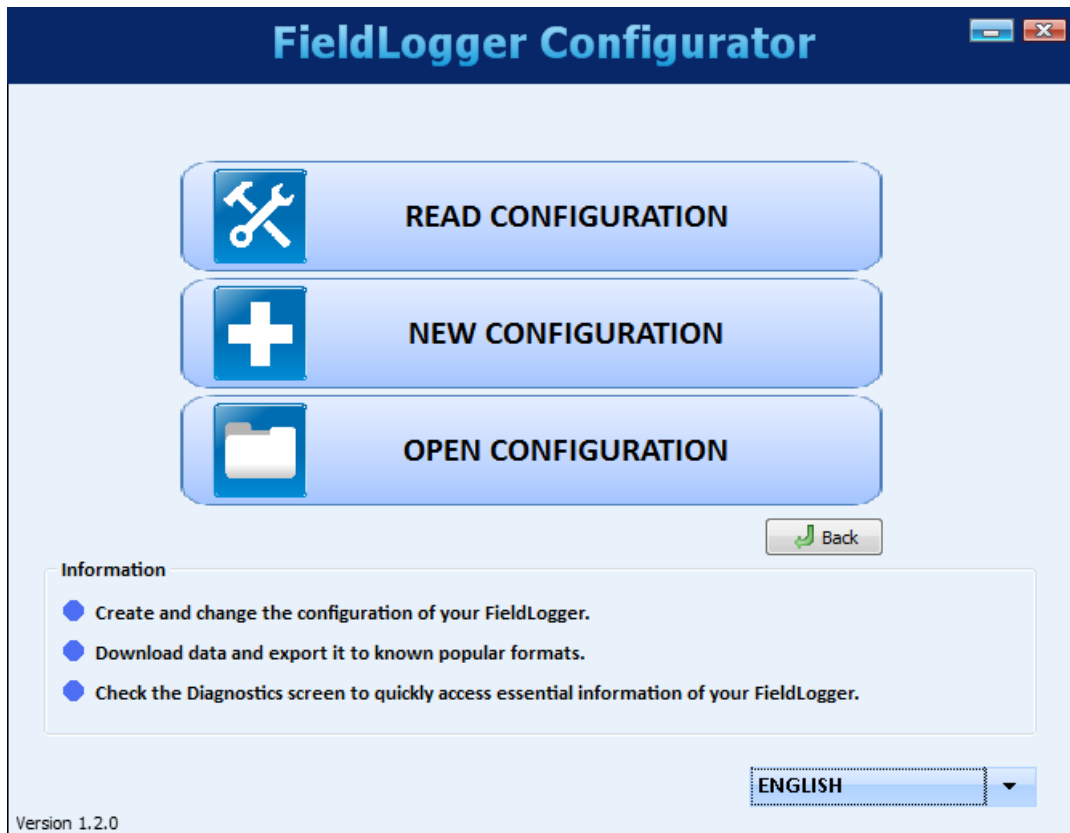
- Configuration: Allows you to change the **FieldLogger** configuration.
- Diagnostics: Allows you to read the values of the enabled channels, the status of configured alarms and general information and device status.
- Download: Allows you to perform data download of **FieldLogger** logging memory, view and export them in various formats.
- Preferences: It allows modifying some software options.



CONFIGURATION

On the configuration screen, you can select one of the following options, as they are described below:


- Read Configuration: Reads the current configuration of a **FieldLogger**.
- New Configuration: Creates a configuration from the scratch.
- Open Configuration: Loads the previously configuration saved to a file.



If the chosen option was to create a new configuration, you must specify a file where this configuration will be saved. Besides that, from software version 1.40 on, you must select which FieldLogger model you are about to configure (power – normal or 24 V – does not care on this case):

- Complete model, with Ethernet, USB, expandible memory using an SD Card and a second RS485 interface ready to accept an optional HMI.
- Model with USB but no Ethernet, non-expandible memory (internal flash only – no SD Card) and only one RS485 interface.

Once the configuration has been loaded into the software (originated from a device, a file, or simply created from the scratch, according to the selected option), then one should make the desired configuration. For this, there is a sequence of screens with various parameters arranged by functionality.

Each time you try to move onto the next screen (via the "Next" button), a check of the configured parameters is done. In case there is any problem with any parameter, an error window is displayed and the symbol "" shows up next to the field that may not be consistent with other previous settings.

The icon bar at the bottom of the window has icons for the following functions, as they are described below:

- Back: It allows coming back to the previous configuration screen.



- Save: Saves the current configuration to a file. If a file has not yet been associated with this configuration, it opens a dialog screen for the user to choose the name and location of the file.



- Connection: Allows the connection to the equipment (opens a window for the interface selection) when it is disconnected and the disconnection when it is connected.



- Load Screen Initial Configuration: Undo the changes introduced by the user, returning to the initial configuration of the current screen.



- Cancel: Closes the current configuration.



- Next: Performs the settings check of the current configuration screen and, if everything is OK, goes to the next screen.



Icon toolbar

GENERAL CONFIGURATIONS

The first screen shows some general parameters of configuration for the **FieldLogger**.

- Tag (name) to be given to the equipment (maximum of 16 characters).
- When using a HMI with the **FieldLogger**, please indicate the level of access that the operator will get through the HMI:
 - No HMI access: Prevents the use of the HMI, because no parameter can be viewed by it in this **FieldLogger**.
 - Parameters reading: HMI can be used only to view the channels and status of the **FieldLogger**, not allowing any type of configuration.
 - HMI configuration and overall reading: HMI can have its own parameters configured, besides viewing the channels and status of the **FieldLogger**.
 - Overall configuration and reading: HMI can be used to configure parameters (its own and some of **FieldLogger**), in addition to viewing the channels and status of the **FieldLogger**.
- Enabling data download by using a USB flash drive: it enables or disables the data download by using a USB flash drive. When enabled, it also indicates the priority in case of a USB flash drive without enough space to download all demanded data: more recent data or older data. In addition, you can configure the number of days (from the day of download, if the priority is the latest, or from the oldest data, if the priority is the oldest) that you want to download. Because of the fact that we do not make a copy of all data from the equipment's memory (which, in the case of SD cards, can be a lot of data), this can accelerate download time significantly.

General Configuration

Tag

Equipment Tag

Clock

PC Date/Time

Current date and time from this computer will be sent to the equipment when applying the new configuration.

HMI

Access Levels

Address

Stop bits

Baud rate

Parity

It is possible to configure the parameters of the HMI RS485 interface.

Data Download by USB Flash Drive

Enable Download

Data Priority

Earliest Data Latest Data

Download Period

Download All Period Days

Back

Next

General Configurations

RS485 INTERFACE CONFIGURATION

Next configuration screen is the RS485 Interface screen. On this screen, you should choose the type of behavior of this interface: whether it will be a Modbus RTU slave, a Modbus RTU master or it shall not be used at all. It is recommended to disable the interface if it is not used.

When it is used as a slave, you must configure your Modbus address, the baud rate, parity and number of stop bits.

When it is used as a master, it is not necessary to configure the Modbus address (only valid for the slaves). Moreover, in this case, the configuration of Modbus network, where it says which registers are read from what slaves, will be carried through later on, on the Remote Channels screen.






RS485 Interface

Mode

Disabled Master Slave

Parameters

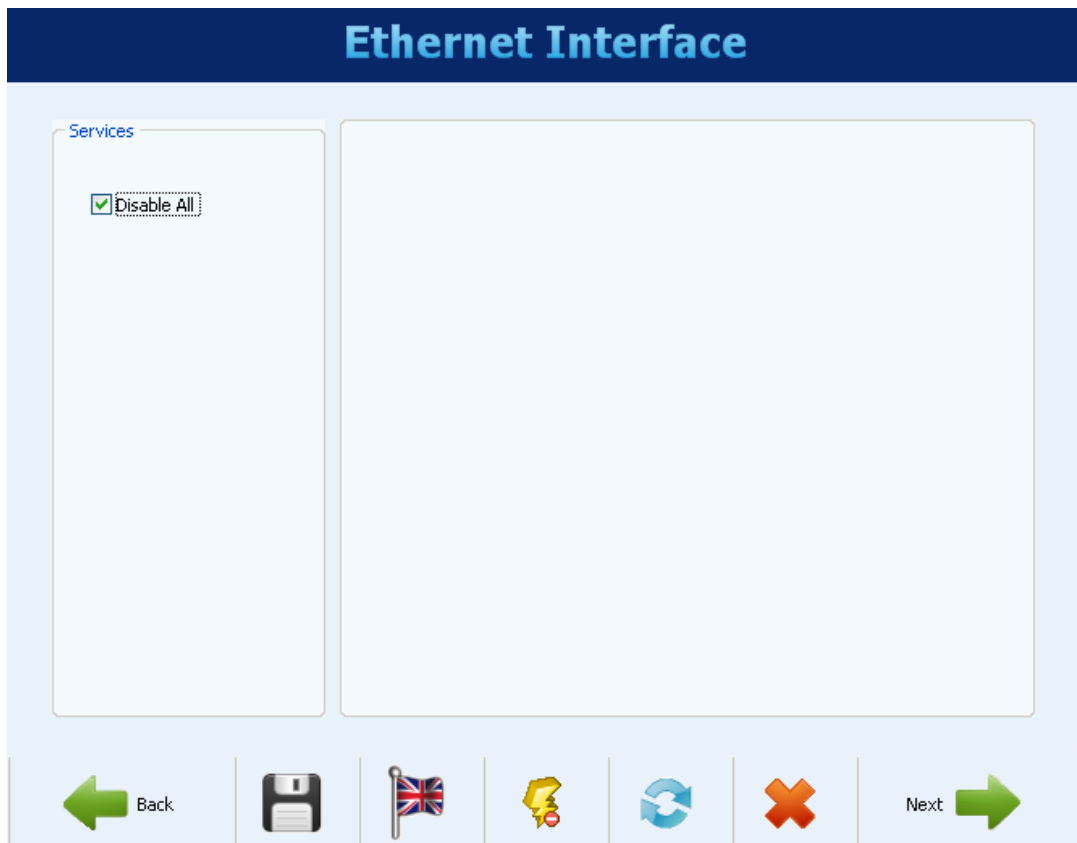
Address <input type="text" value="1"/>	Stop Bits <input type="text" value="2"/>
Baud Rate <input type="text" value="115200"/>	Parity <input type="text" value="None"/>

← BackNext →

Interface RS485

ETHERNET INTERFACE CONFIGURATION

The configuration of the Ethernet interface should be carried through on the next screen. If it is desired not to use this interface, it is recommended to disable it, as shown in the following figure.



Disabled Ethernet Interface

ETHERNET INTERFACE CONFIGURATION - TCP/IP

Once the interface is enabled, the buttons on the left allow you to enable and configure each of the services offered by this interface. The icon on the right of each button shows whether the related service is enabled or not.

The first configuration to be made is the selection of using fixed IP or DHCP and, in the case of fixed IP, to choose the parameters relating to it, such as **FieldLogger** IP, the subnet mask and default gateway.

Moreover, we must choose whether or not to use DNS, which can be used to connect to the e-mail server or FTP server (when **FieldLogger** is the FTP client for the daily download of data through this service). If so, you must configure the DNS server's IP number or, if the DHCP option has been selected, you can choose to search for the DNS server's IP from the DHCP server.

Ethernet Interface

Services

Disable All

TCP/IP

FTP ✖

SMTP ✖

SNMP ✖

HTTP ✖

Modbus TCP ✖

i Click on the buttons to set up each service.

TCP/IP

IP Configuration

Get IP configuration automatically (DHCP)

Use the following IP configuration

IP Address:

Sub-Network Mask:

Standard Gateway:

DNS Configuration

DNS Disabled

Get DNS configuration automatically (DHCP)

Use the following DNS configuration

DNS Server:

←
Back

💾
🇬🇧
⚡
🔄
✖

Next
→

Ethernet Interface - TCP/IP Configuration

ETHERNET INTERFACE CONFIGURATION – FTP

The FTP button allows you to configure the options related to the FTP services. There are two types of FTP related functionality to choose from in the **FieldLogger**: client and server.

As a server, **FieldLogger** allows for an external client to connect to it in order to download logged data, both from the SD card as well as from the internal memory. For this, you must configure the connection and access data, like user name (maximum of 10 characters), password (maximum of 10 characters) and port for the connection.

As a client, it can automatically connect to an FTP server to send data from its logging memory (internal or SD card). This can either be done once a day at a set time, or many times a day (from firmware version 1.50 on) in a configurable time interval. This way, you must configure the access parameters so **FieldLogger** will be able to access the server, like user (maximum of 50 characters) and password (maximum of 10 characters), in addition to the IP address or server name (in case you enabled the DNS – name being up to 50 characters) and the server's port. Besides that, since firmware version 1.40, you can configure the format of the file created by the download: binary (standard) or CSV (comma separated value) and also select the option that deletes the logging files after the download (valid only when logging into an SD card).

The screenshot shows the 'Ethernet Interface' configuration page. On the left, under 'Services', there are buttons for 'Disable All', 'TCP/IP', 'FTP' (which is active and has a green checkmark), 'SMTP', 'SNMP', 'HTTP', 'Modbus TCP', and 'Cloud'. A note says 'Click on the buttons to set up each service.' The main area is titled 'FTP' and contains two sections:

- Access Data Via FTP:** This section is checked. It includes fields for 'User' (FLogger), 'Password' (masked with dots), and 'Port' (21). A green checkmark icon is visible to the right.
- Daily FTP Download:** This section is also checked. It includes fields for 'Address' (192.168.1.10), 'Port' (21), 'User' (DataLogger), and 'Password' (masked with dots). It also has a 'Time' field set to 02:30 with a 'Periodic' checkbox, a 'Format' dropdown menu set to 'binary', and an 'Erase logs after download (only for SD card)' checkbox. A clock icon and a green checkmark icon are visible to the right.

At the bottom of the page, there are navigation buttons: 'Back' (left arrow), a floppy disk icon, a lightning bolt icon, a refresh icon, a red 'X' icon, and 'Next' (right arrow).

Ethernet Interface - FTP Configuration – Example 1

Ethernet Interface

Services

Disable All

TCP/IP

FTP

SMTP

SNMP

HTTP

Modbus TCP

Cloud

Click on the buttons to set up each service.

FTP

Access Data Via FTP

User:

Password:

Port:

Daily FTP Download

Address:

Port:

User:

Password:

Time: Periodic

Format:

Erase logs after download (only for SD card)

Back

Next

Ethernet Interface - FTP Configuration – Example 2

ETHERNET INTERFACE CONFIGURATION - SMTP

The SMTP button opens the parameters related to sending e-mails. The **FieldLogger** allows, in situations of alarm or event, e-mails to be sent to multiple receivers. On this screen, the parameters related to the access to the e-mail server must be configured, such as its IP address or server name (in case you enabled the DNS – name being up to 50 characters), in addition to the user (maximum of 50 characters) and password (maximum of 12 characters).

Finally, you must configure the parameters of the e-mail to be sent in case of an alarm event. This e-mail has a subject (maximum of 32 characters) and has a part of the message body that is user defined (up to 64 characters) and that is the same for all alarms or events. The e-mail of the sender (maximum of 50 characters) and the e-mails of the receivers (maximum of 50 characters for each one) must also be configured.

Ethernet Interface - SMTP Configuration

ETHERNET INTERFACE CONFIGURATION - E-MAIL RECEIVERS

For the insertion of the of e-mail receivers, you should click on the button "Edit List". A new window will open, allowing for the inclusion and removal of e-mails from the receivers list. All potential receivers of alarm or event e-mails must be included in this window. The decision of which alarms or events will be sent to which receivers will be made later, on alarms configuration screen!

Ethernet Interface - Configuration of E-mail Receivers

ETHERNET INTERFACE CONFIGURATION - SNMP

The SNMP protocol can be enabled and configured by clicking on the SNMP button. SNMP in the **FieldLogger** is read-only. Thus, you should set up the community for access (maximum of 16 characters) and connection port.

For using traps, you must enable them separately. You should also set up the IP address and destination port for the traps.

Ethernet Interface

Services

Disable All

TCP/IP


FTP

SMTP

SNMP

HTTP

Modbus TCP

 Click on the buttons to set up each service.

SNMP

Enabled








OID Readings

Public Community Port

Traps Sending

Enabled Traps Sending

Address Port

 Back      Next 

Ethernet Interface – SNMP Configuration

ETHERNET INTERFACE CONFIGURATION – HTTP

The HTTP button enables **FieldLogger** to serve a web page with some data from the equipment. This page has an auto-refresh parameter, indicating to the navigator software (browser) that the page should be reloaded with updated data from time to time. For this, the configuration needed is just the connection port and the time in seconds between page updates.

The screenshot shows the 'Ethernet Interface' configuration page. The title bar is dark blue with 'Ethernet Interface' in white. The main content area is light blue and divided into two sections: 'Services' and 'HTTP'.

Services: A vertical list of buttons for enabling services. At the top is a checkbox labeled 'Disable All'. Below it are buttons for 'TCP/IP', 'FTP' (with a green checkmark), 'SMTP' (with a green checkmark), 'SNMP' (with a green checkmark), 'HTTP' (with a green checkmark), and 'Modbus TCP' (with a red 'X' icon). A blue information icon is followed by the text: 'Click on the buttons to set up each service.'

HTTP: A section with a checked checkbox labeled 'Enabled'. Below it is an 'Access' box containing two input fields: 'Service Port' with the value '80' and 'Web Page Update Time (s)' with the value '1'.

At the bottom of the page is a navigation bar with icons and labels: a green left arrow labeled 'Back', a floppy disk icon, a UK flag icon, a yellow lightning bolt icon, a blue circular refresh icon, a red 'X' icon, and a green right arrow labeled 'Next'.

Ethernet Interface – HTTP Configuration

ETHERNET INTERFACE CONFIGURATION – MODBUS TCP

Finally, the Modbus TCP button allows you to enable the Modbus TCP communication protocol, used to read and write data in **FieldLogger**. Additionally the Configuration software itself uses this protocol to communicate with **FieldLogger** in order to read and write configuration parameters, view diagnostic data and download logging data, when Ethernet interface has been selected. **FieldLogger** should be accessed by the “255” identification (ID). Any other ID used in a **FieldLogger** Modbus-TCP access will be understood as being targeted to a RS485 slave in the RS485 network, reached through the gateway function. On this case, if this functionality is enabled, the data packet will be forwarded to the RS485 bus.

When RS485 interface is configured as a Modbus master and Modbus TCP protocol is enabled, the gateway functions can be enabled, which allows the user to send Modbus commands by the Ethernet interface (Modbus TCP) to the slaves connected to the Modbus RTU network through **FieldLogger**.



FieldLogger operation as a gateway between a Modbus TCP network and a Modbus RTU network is only available from firmware version 1.10 on.

You can choose, from firmware version 1.40 on, the communication protocol of this interface between “Modbus TCP” or “Modbus RTU over TCP”.

Ethernet Interface - Modbus TCP Configuration

ETHERNET INTERFACE CONFIGURATION – CLOUD

From firmware version 1.40, **FieldLogger** allows to connect to a remote *machine-to-machine* (M2M) server as a way to turn its data available through the cloud (Internet).

The Cloud button makes it possible to enable data access through the cloud. Authentication parameters indicate how **FieldLogger** should connect to the remote server. IP address (or URL, if DNS is enabled) and server connection port must be filled, as the desired authentication mode. When selecting NAP as the authentication mode, the port will be fixed in the correct value and a few other fields needed to the authentication will be shown.

Parameters related to the protocol are on the bottom screen area. You can choose assign a Modbus address to the **FieldLogger** in order to send commands directly to them. Commands received with different addresses will be routed to **FieldLogger** RS485 network if it is configured as a Modbus master (RS485 screen) and the gateway option is enabled (button "Modbus TCP"). Besides that, there is an option of choosing the cloud connection protocol ("Modbus TCP" or "Modbus RTU over TCP") and a time out for the reconnection. This time out checks for the maximum period of time that **FieldLogger** can wait without receiving any Modbus command from the cloud: if none is received within this period, it is assumed that the connection was lost and it tries to reconnect to the cloud. In order to disable this time out, configure its value as "0".

Ethernet Interface – Configuration of the Access to the Cloud

ANALOG CHANNELS CONFIGURATION

On the next screen, you must configure the analog channels to be used. Each channel is individually configured, so you should first select which channel to be configured in the list on the left.

After the channel has been selected, you must configure its parameters on the right. For each channel, you must configure a tag (name with a maximum of 16 characters) and an input type. Depending on the selected input type, the indication limits must also be configured. For temperature sensors, you must choose whether the indication will be in Celsius or Fahrenheit, for the others, you can type a string for the unit (maximum of 10 characters).

There is also the option to enter an error value to be displayed when an error is detected on the input signal, such as an open 4-20 ma loop or a Pt100 with a broken cable. There is also the possibility to configure a digital filter for the input channel (the higher the value is, more filtered is the indication of the channel, making the response more immune to noises on the input signal, but also slower to respond to variations - maximum filter value is 20).

There is the option of using the Custom Calibration. This feature allows up to 10 pairs of points to be inserted in a "correction table" (per analog input) in the device, creating segments for adjustments to the indicated value. Further details in the "**FieldLogger** Operation" chapter.

The number of decimal places to be displayed must also be configured. This parameter refers to the following cases described below:

- Reading the value of the channel via Modbus 16 bits registers (INT16 with signal). Further details in the document "FieldLogger – Modbus".
- Reading the value of the channel via HMI.
- Reading the value of the channel through the HTML page generated by **FieldLogger** itself (HTTP service on the Ethernet interface).
- Reading the value of the channel through the OID reading of SNMP protocol (SNMP service of Ethernet interface).
- Reading the alarm value related to the channel when receiving e-mails from the **FieldLogger** (SMTP service on the Ethernet interface).

Analog Channels - Configuration of a temperature channel

Analog Channels

Channels

- Channel 1 Enabled
- Channel 2 Enabled
- Channel 3 Enabled
- Channel 4 Enabled
- Channel 5 Enabled
- Channel 6 Enabled
- Channel 7 Enabled
- Channel 8 Enabled

Scan Interval

x 1 ms
 x 1 s

Parameters

Tag

Error Value

Input Type

Limits
Min. Max.

Unit
 °C °F

Digital Filter

Decimal Places

Configured Calibration Points 0

Back

Next

Analog Channels – Configuration of a linear channel

ANALOG CHANNELS CONFIGURATION – CUSTOM CALIBRATION

In the "Custom Calibration" button, you can enter up to 10 custom calibration points for each analog channel. The correct way to do this is as described below:

1. Disable the custom calibration of the channel to be adjusted, deleting all points configured for it, and apply this setting.
2. In the points to be adjusted, apply the standard value and write down the value indicated by the equipment.
3. Afterwards, insert the pairs of Custom Calibration points (source value and indicted value) and apply the configuration.

Customized Calibration

CHANNEL 6

Enabled

Values

Standard: 24 FieldLogger: 25

+ Add ✖ Delete

✖ Delete all

#	Standard indication	FieldLogger indication

✓ Apply ✖ Cancel

Analog Channels - Custom Calibration

Customized Calibration

CHANNEL 6

Enabled

Values

Standard: FieldLogger: |


+ Add ✖ Delete

✖ Delete all

#	Standard indication	FieldLogger indication
1	24,000000	25,000000

✓ Apply ✖ Cancel

Analog Channels - Custom Calibration

	<p>All customized calibration points should be deleted before measuring new points for another customized calibration! The existence of previous points will interfere in the measurements and the new calibration might have errors due to this fact.</p> <p>For the same reason, customized calibration points should be configured in the FiledLogger all at the same time.</p>
---	---

DIGITAL CHANNELS CONFIGURATION

After configuring the analog channels, it is time to configure the digital channels and relays. Just as it is in the analog channels, on the list on the left, you can select which channel is to be configured.

Each channel can be configured as an input or an output. As an input, you can enable it or not. If it is disabled, it will not appear as an option in the logs, alarms, in the virtual channels or even in the HMI. Once the input has been enabled, you must provide a unique tag (name - maximum of 16 characters) for this channel. You should also provide a value to be displayed when in "0" level (low voltage level or contact closed at the input) and another value to be indicated when in "1" level (high voltage level or contact open at the input). These values will be shown in the channel reading. Finally, you can optionally configure a unit (maximum 10 characters) for the input.

Digital channels - Configuring an input

From firmware version 1.10 on, it is possible to perform counting on the digital inputs. In order to do that, no special configuration is needed; just configure digital channels as inputs. The counting values can be accessed by Modbus registers (check the document "FieldLogger – Modbus") and can also be copied to a virtual channel, where it can be logged or used by the alarms, for example. When applying a new configuration in the digital channels, the all previously collected counting values are reset to zero.

When configured as an output, you should indicate whether this output may be triggered by **FieldLogger** alarms & events or if it will be controlled by external Modbus commands, coming from a PLC or SCADA software, for example.

Digital Channels

Channels

- Channel 1 **Input**
- Channel 2 **Input**
- Channel 3 **Input**
- Channel 4 **Input**
- Channel 5 **Input**
- Channel 6 **Input**
- Channel 7 **Output**
- Channel 8 **Input**
- Relay 1 **Output**
- Relay 2 **Output**

Parameters

Mode

Input Output

Output Control

Alarm controlled output
 Modbus controlled output

i Activated by Modbus commands sent by an external master (example: SCADA software tools. Modbus commands supported: 'Write Single Coil', 'Write Single Register' and 'Write Multiple Registers'.)

← Back | Save | UK Flag | Warning | Refresh | Cancel | Next →

Digital channels – Configuring an output

The two **FieldLogger** relays are also configured on this screen and their configuration is similar to that of other digital outputs. You should just indicate whether they are triggered by internal alarms or external Modbus commands.

Digital Channels

Channels

- Channel 1 **Input**
- Channel 2 **Input**
- Channel 3 **Input**
- Channel 4 **Input**
- Channel 5 **Input**
- Channel 6 **Input**
- Channel 7 **Output**
- Channel 8 **Input**
- Relay 1 **Output**
- Relay 2 **Output**

Parameters

Mode

Input Output

Output Control

Alarm controlled output
 Modbus controlled output

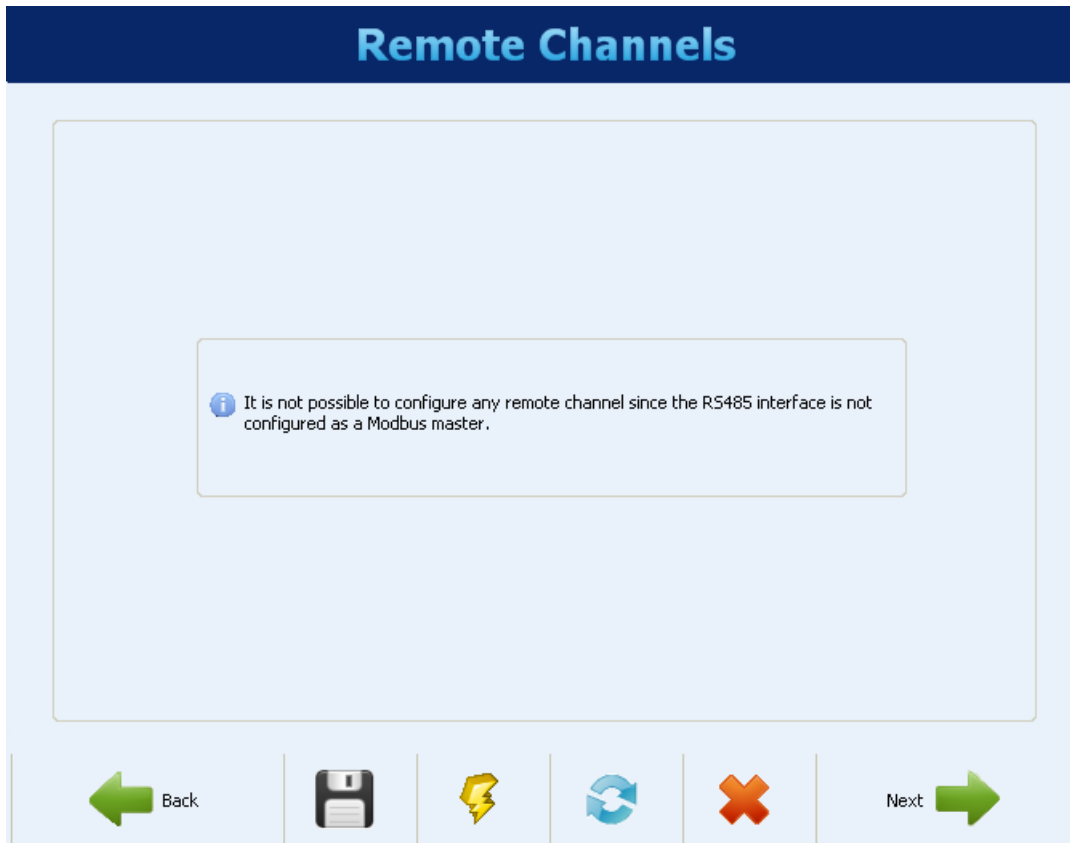
i It will be eligible to be activated during an alarm condition. Alarms will be configured later.

← Back | Save | UK Flag | Warning | Refresh | Cancel | Next →

Digital Channels - Configuring a relay

REMOTE CHANNELS CONFIGURATION

The configuration of remote channels, made on the next screen, is only available when the RS485 interface has been configured as a Modbus master. In the case of the RS485 interface having been configured as a slave or disabled, the remote channels screen shall display a message indicating the inability of its configuration.



Remote Channels Disabled

If the RS485 interface was configured as Modbus master, the following screen will be displayed. You should set up a tag (name - maximum of 16 characters), unique for each channel, and optionally a unit (maximum of 10 characters) for the reading value.

In addition, for each channel, you should set up which network slave is to be read, what Modbus command should be used and what is the initial register to be read from the slave. In the current version, the number of registers is always "1", which means that you cannot do block reading.

An error value must also be configured. This value is shown on the channel when there is a problem, for example, a communication error with the slave. The number of decimal places of the channel value must be inserted in the "Decimal Places" field (available from firmware version 1.40 on). Configuring one decimal place, for example, will make a value read of "2705" to be considered as "270.5" by the **FieldLogger**. It must be also informed whether the value being read is signed or unsigned, which depends basically on how the slave puts its information available.

At the end of the channel configuration, you must click on the "Add" button in order to enter the channel in the list to the left. If you want to remove a channel from the list, you must select it from the list and click on "Remove".

Remote Channels

Channels

0/64

Channels parameters

Tag
Temperature

Modbus Slave Address: 1 Modbus Command: 03 - Read Holding Registers

Initial Register: 0 Unit: °F

Error Value: -100 Decimal Places: 0

Unsigned value

+ Add/Modify ✖ Delete 🗑 Delete All

Configuration

Reading Interval (x 0.1 s): 20 Attempts: 3 Max Response Time (ms): 500 Time Between Commands (ms): 50

← Back 💾 ⚡ ↻ ✖ Next →

Remote Channels - Setting up a channel

At the bottom of the screen there are the general parameters of the Modbus Master configuration. The reading interval, given in tenths of seconds (maximum 18,000, equivalent to 30 minutes) is the time that you want **FieldLogger** to make a new scan of all configured remote channels. The number of trials (valid range: 1 to 10) is how many attempts are made in sequence for the reading of each channel (if the communication fails in all attempts it will display the error value set up for the channel).

The maximum response time (valid range: 2 to 10,000 ms) indicates how long, after sending the command from the master, it will wait for the slave's response. If the answer does not come within this time, this will be considered a communication error and a new try (if configured) will be carried through. The time between commands (valid range: 1000 to 5000 ms) indicates how much time **FieldLogger** will wait between receiving the slave's response and sending the next command.

Remote Channels

Channels

..... Temperature

1/64

Channels parameters

Tag
Temperature

Modbus Slave Address: 1 Modbus Command: 03 - Read Holding Registers

Initial Register: 0 Unit: °F

Error Value: -100 Unsigned value

+ Add/Modify ✖ Delete 🗑 Delete All

Configuration

Reading Interval (x 0.1 s): 20 Attempts: 2 Max Response Time (ms): 500 Time Between Commands (ms): 50

← Back 💾 ⚡ ↻ ✖ Next →

Remote Channels - Inserting a channel in the list

VIRTUAL CHANNELS CONFIGURATION

The following screen allows the configuration of the virtual channels. Each virtual channel is the result of a mathematical or logical operation and must be configured by selecting a unique tag (name - maximum of 16 characters) for this channel. You should then select the first channel that will serve as the operand (depending on the selected operation, it will be the only one). When you select "Constant Value", you will be able to assign a numeric value to the virtual channel (this value can be used as an operand in other virtual channels). After that, you must choose the operation to be performed and which channel is to be used as the second operand in the operation (when previously chosen "Constant Value", there should be placed the numeric value of the channel).

Finally, one should choose a unit (optional - maximum of 10 characters) for the channel, plus an error value and the number of decimal places desired in the indication of the same one. When clicking on "Add", the newly configured channel is added to the list of virtual channels.

When a virtual channel is configured, all enabled input channels are available for use as operands, including virtual channels already placed in the list. This enables us to generate relatively complex expressions, using the result of an operation as an operand in another one. For more details, please see the section "Virtual Channels" under the chapter "FieldLogger Operation".

Clicking on any virtual channel in the list, its parameters are loaded at the top fields. To delete a channel, you must select it from the list and click on "Remove". To delete all the virtual channels, you must click on "Remove All".

Virtual Channels

Tag Temp	Channel 1 = BoilerTemp	Operator -	Channel 2 Furnace
Unit °F	Error Value 2	Decimal Places 2	+ Add

Channels

Tag	=	Descrição
Temp	=	BoilerTemp - Furnace

✖ Delete
🗑 Delete All

← Back

Next →

Virtual Channels

ALARMS CONFIGURATION

After setting up all channels, you can configure alarms in order to indicate error or exception conditions. For this, we must choose which channel must be used for the alarm, what is the alarm condition and what is the set point (trigger value for the alarm). For example, you can select an analog temperature channel to alarm when the temperature exceeds a critical threshold, or a digital input channel to alarm when your state is different from the expected value.

A hysteresis can be configured to prevent a marginal condition, such as an input that hovers around the set point value, which would generate multiple alarm events. In some cases, like when the alarm channel is a digital input, the hysteresis does not make much sense and should be maintained at "0".



Whenever a digital channel is used for an alarm, hysteresis shall not be used (must be configured with "0")!

Each alarm can have one or more associated actions. You should then choose what actions should be performed on the occurrence of an alarm or event (different actions organized by tabs). The available actions are the activation of relays, the activation of digital outputs (assuming they are configured to be triggered by an alarm), the sending of e-mails to one or more receivers (selected from among the ones configured on the Ethernet interface configuration page), sending a SNMP trap and the start and/or stop of the loggings. Finally, when everything is set up, you should include the alarm in the list clicking on the "Add" button.

By clicking on an alarm from the list on the left, its parameters are loaded into the fields on the right. To delete a channel from the list, you must select it from the list and click on "Remove". To modify some parameter of an alarm, you must select it from the list, change whatever you want and click on "Modify". The button "Delete all" deletes all alarms in the list.

The screenshot shows the "Alarms" configuration interface. On the left, there is a list of alarms, currently empty, with a "0/32" indicator at the bottom. The main area is titled "Parameters" and contains the following fields:

- Channel:** A dropdown menu set to "Furnace".
- Condition:** A dropdown menu set to "Greater than (>)".
- Setpoint:** A text input field containing "250".
- Hysteresis:** A text input field containing "0,5".

Below these fields are several tabs: "Relays", "Digital Outputs", "Logs", "E-mail", "Traps", and "Internal variables". The "Relays" tab is active, showing two checkboxes: "Relay 1" (checked) and "Relay 2" (unchecked). Below the checkboxes is an information icon and the text: "Select the relays you wish to activate while this alarm condition is on." At the bottom of the parameters section are four buttons: "+ Add", "Delete", "Modify", and "Delete All".

At the very bottom of the interface is a navigation bar with icons for "Back", a floppy disk, a lightning bolt, a refresh icon, a red "X", and "Next".

Alarms Configuration - Relays selection

Alarms

Alarms

0/32

Parameters

Channel

Condition

Setpoint

Hysteresis

Relays
Digital Outputs
Logs
E-mail
Traps
Internal variables

<input type="checkbox"/> Digital 1	<input type="checkbox"/> Digital 5
<input type="checkbox"/> Digital 2	<input type="checkbox"/> Digital 6
<input type="checkbox"/> Digital 3	<input type="checkbox"/> Digital 7
<input type="checkbox"/> Digital 4	<input checked="" type="checkbox"/> Digital 8

i Select the digital outputs you wish to activate while this alarm condition is on.

+ Add
✖ Delete
↻ Modify
🗑 Delete All

← Back

Next →

Alarms Configuration - Digital outputs selection

Alarms

Alarms

0/32

Parameters

Channel

Condition

Setpoint

Hysteresis

Relays
Digital Outputs
Logs
E-mail
Traps
Internal variables

Start Logging

Stop Logging

Log while in alarm condition

i Inform if this alarm condition must start and/or finish data logging.

+ Add
✖ Delete
↻ Modify
🗑 Delete All

← Back

Next →

Alarms Configuration - Logs control configuration

Alarms

Alarms

0/32

Parameters

Channel

Condition

Setpoint

Hysteresis

Relays Digital Outputs Logs E-mail Traps Internal variables

supervisao@fieldlogger.com.br

i Inform which e-mail receivers must be notified when entering this alarm condition.

Alarms Configuration - E-mail receivers selection

Alarms

Alarms

0/32

Parameters

Channel

Condition

Setpoint

Hysteresis

Relays Digital Outputs Logs E-mail Traps Internal variables

Enable Traps

i Inform if a SNMP trap must be triggered when entering this alarm condition.

Alarms Configuration - Enabling SNMP traps

Alarms

Alarms

0/32

Parameters

Channel
Furnace

Condition
Greater than (>)

Setpoint
250

Hysteresis
0,5

Relays
Digital Outputs
Logs
E-mail
Traps
Internal variables

Preset all accumulators

Preset all counters

Preset a single accumulator/counter

Channel name:

Preset value:

Alarms Configuration – Selection the internal variables

Alarms

Alarms

Alarm: 1

1/32

Parameters

Channel
Furnace

Condition
Greater than (>)

Setpoint
250,000

Hysteresis
0,500

Relays
Digital Outputs
Logs
E-mail
Traps
Internal variables

Preset all accumulators

Preset all counters

Preset a single accumulator/counter

Channel name:

Preset value:

Alarms Configuration - Alarm added to the list

LOGS CONFIGURATION

The last page of the configuration is about logging. If data logging is not desired, you should disable it.

Logs configuration should be carried through initially by choosing the start mode and stop mode for the logging process. If, on the previous screen, the start and/or stop of the loggings were assigned to one or two alarms or events, this option is sealed and cannot be changed on the Logs screen.

If you want to use the start and/or stop of the loggings through Modbus commands, you must enable these options. In addition, you must select which is the memory where the logging data must be stored: in the internal flash (512k logs) or in the SD card inserted by the user.

Finally, you must select which channels you want to log and what is the desired log rate. The channels can be selected for logging moving them from the left side column (available channels) to the right side column (channels to be logged). A maximum of 100 channels can be logged, but keep in mind that the more channels to be logged, the slower is the logging rate that can be used.


The logging rate is given as a logging interval and it is common to all channels. In other words, a rate of 1 second means that all channels selected for registration will be logged once per second. Although the equipment allows for a rate of up to 1000 logs per second, you must bear in mind the following side effects, as they are described below:

- It is not good to have a logging rate faster than the reading scan of the analog channels or than the reading scan of the remote channels. In such a case, the logs would have repeated data.
- The more logs we have in memory, the slower the download process will be and more data will be processed in preview and export.

Logs Configuration – Logging configuration

After finishing the entire configuration, you can send it to the equipment. Just click on the "Send" button. If the configuration was previously read from the device and the interface was not disconnected, the same interface used for reading will be used for writing. In any other case, we must choose which interface to use for sending the configuration.

Send Configuration to Equipment



Actions

Send

Reiniciar Registros ao Enviar Configuração

Save Configuration to File

File

Current configuration file

Save to a new file



Actions

 Save

 Back











Next 

At the end of the transmission, a message shall appear indicating the success (or not) of the operation. After the transmission, if desired, you can save the configuration to a file to be retrieved in the future.

Configuration

Writing 2 / 9

Writing Ethernet interface configuration...

If, instead of sending the configuration to the equipment, you just want to save it to a file, you must choose the file name and click on the "Save" button.

DIAGNOSTICS

When you select the Diagnostics, the login screen will appear and you should indicate what type of interface to be used for reading the diagnostics parameters: RS485 (RS485 interface of the equipment should be selected as "slave"), USB or Ethernet (the Ethernet interface of the equipment must be enabled, as well as Modbus TCP protocol).

The reading of the parameters is then performed and the General parameters window is opened. This window shows the equipment's tag, serial number, firmware version and model. It also shows the time of its clock compared to the computer's clock. In this window you can also see a series of configuration parameters of the RS485 interface. For the Ethernet interface, the current status (connected or not) is indicated, as well as the IP and MAC numbers and the status of the connection to the Cloud. On the right side of the window, there is an indication of the connection status of the HMI and the USB flash drive, in addition to the capacity and free space of the internal flash memory and the SD card (when connected). Finally, there is an indication of the current state of the loggings and, when the start or stop of these through Modbus commands is enabled, there are buttons in order to perform the respective actions of starting and stopping the logs.

Tag	
Rede NOVUS	
Serial number	11018327
Firmware version	1.42
Model	Standard

Clock	
Clock	17/10/2013 13:35:08
PC Clock	17/10/2013 13:35:09

RS485		Ethernet	
Enabling	✓	Enabling	✓
Mode	Master	Status	Connected
Baud rate	115200	IP Address	10.51.10.30
Parity	None	MAC	00:26:A4:00:00:9E
Stop bits	1		-----
Address	1	Cloud	Authenticated

HMI	
Status	connected. ✓

USB Flash Drive	
Status	Disconnected. ✗

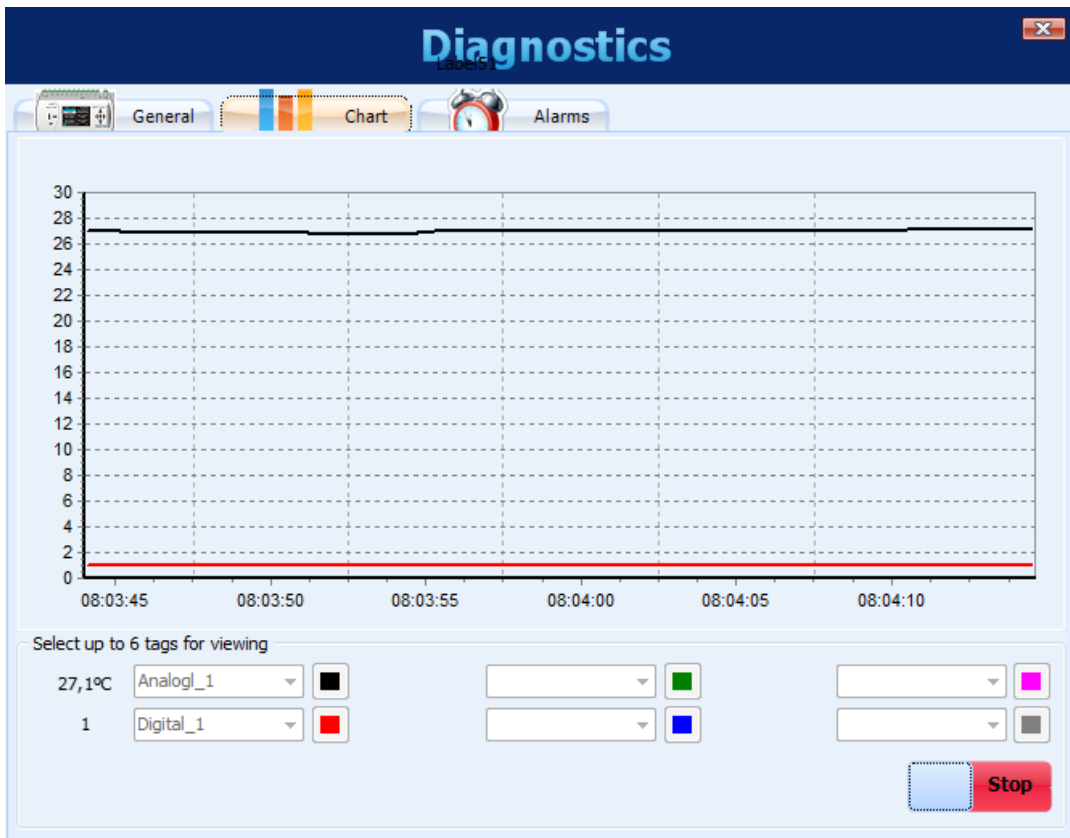
Flash	
Capacity	2162688 ✓
Free Space	2162688 ✓

SD Card	
Capacity	--- ✗
Free Space	--- ✗

Loggings	
Status	Logging <input type="text"/>

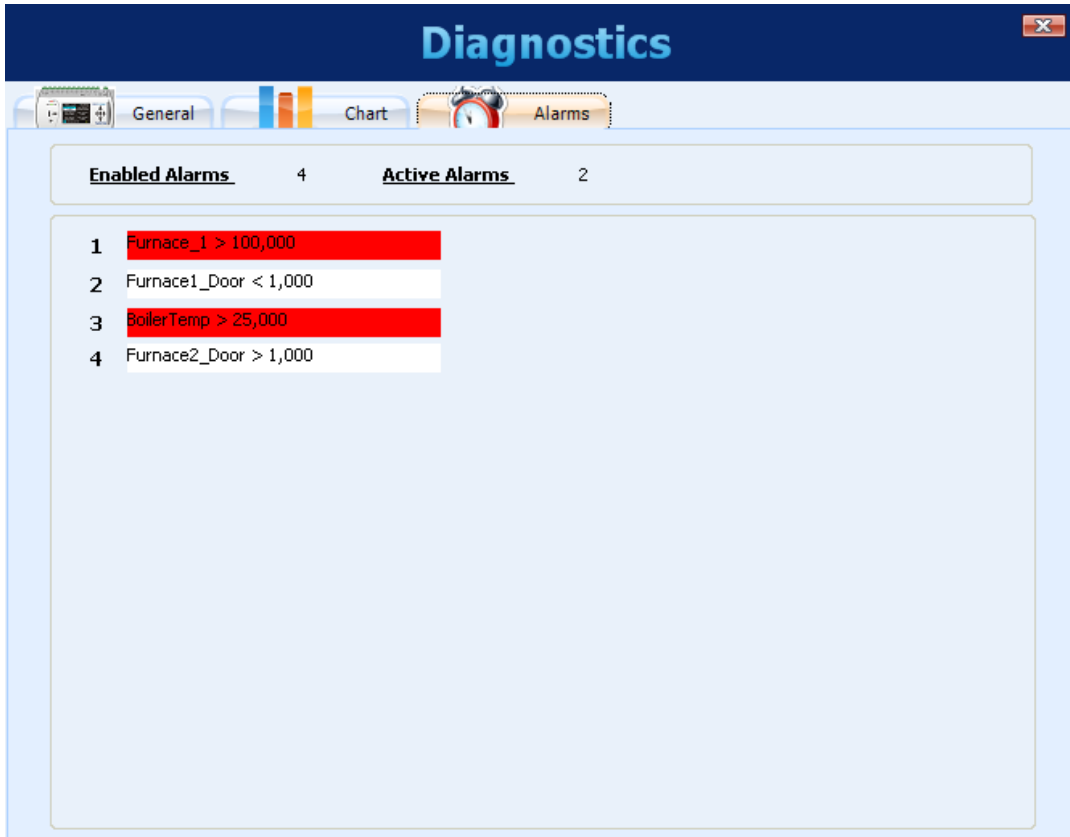
Diagnostics - General Status

Selecting the Chart tab, you can select up to 6 channels to be viewed in a chart. At the bottom, you can select the channel to be displayed and its associated color on the chart. When all desired channels are selected, you must click on the "Start" button and the channel values will be read every 2 seconds (approximately) and will be plotted on the chart. If any channel is in error, the channel selection will be shown in red.



Diagnostics - Monitoring channels

Selecting the Alarms tab, you can check the real-time status of all configured alarms or events. At the top, there is an indication of how many alarms are enabled and how many are in a state of alarm. In the list below, the settings for each alarm are shown. If the alarm is active, its configuration is shown in red.



Enabled Alarms	4	Active Alarms	2
1	Furnace_1 > 100,000		
2	Furnace1_Door < 1,000		
3	BoilerTemp > 25,000		
4	Furnace2_Door > 1,000		

Diagnostics - Monitoring Alarms

DOWNLOAD

Selecting the Download, you can perform the data download of **FieldLogger**, search data previously downloaded from a folder or even view or export logged data.

The idea is that users shall create a folder on their computer (or their network) where a logging database will be created. This database may have data from one or more **FieldLogger's** and will be the destination of all data downloaded from the equipment. From this database, the views and data export will seek the channel data.



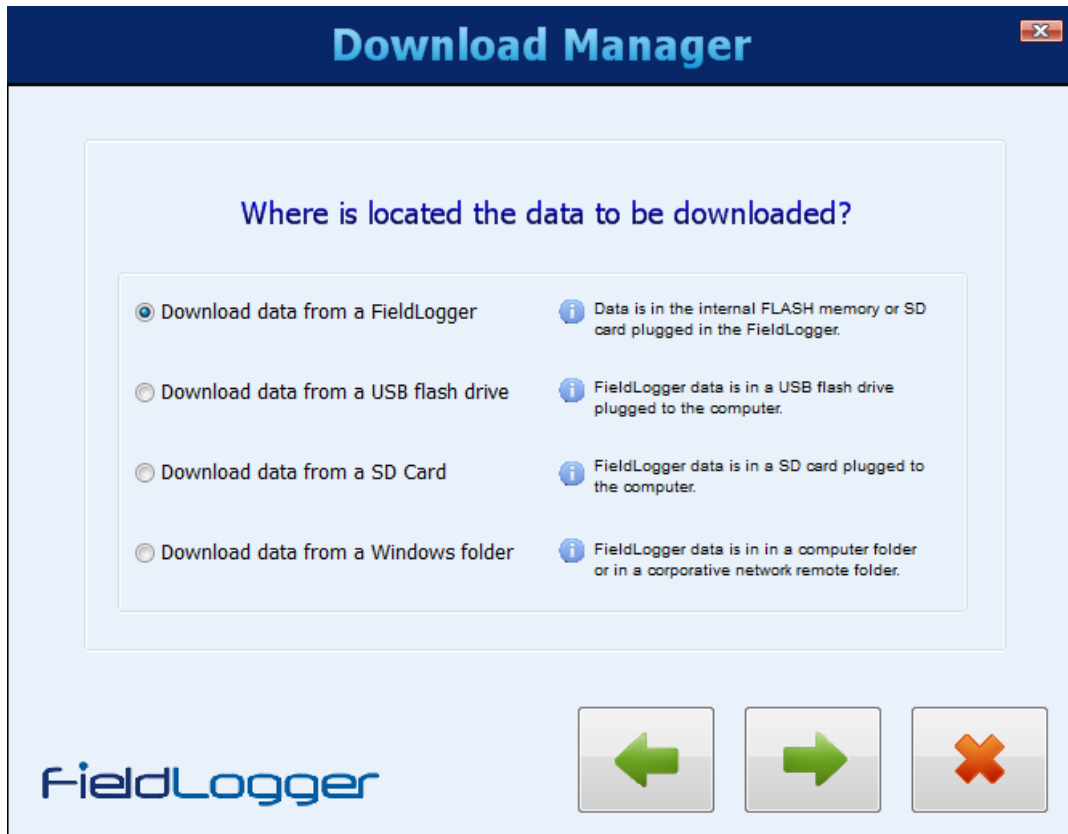
The Download Manager screen has the following options:

- **Download Data**
- **Download Manager**

These options will be viewed in detail in the following sections.

DOWNLOAD DATA

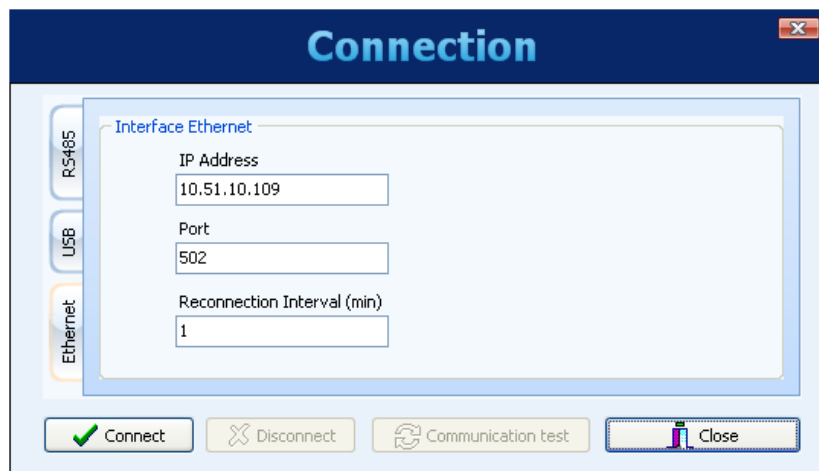
When selecting this option, first thing to do is choose the data source, i.e., where the software should read data from.



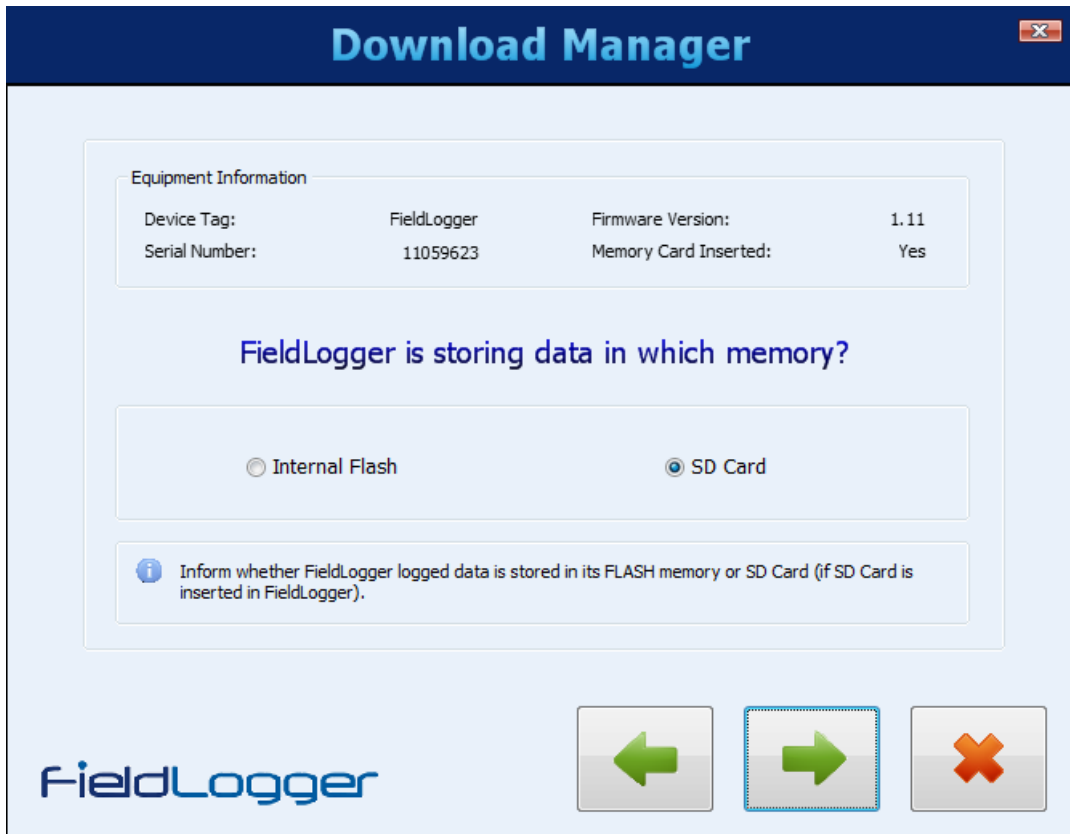
These are the available options:

- Download data from a **FieldLogger** (requires a connection with the equipment).
- Download data from a USB flash drive (used in cases when the flash drive was used to retrieve data from **FieldLogger**). The flash drive must be plugged in the computer.
- Download data from a SD card. The card must have been used in **FieldLogger** as the logging memory target. Recommended when the card has too much logging data, because it is the fastest way of moving data to the computer.
- Download data from a Windows folder. This folder/directory can be located in your local computer or somewhere in your network. This option should be used to process data previously downloaded via FTP.

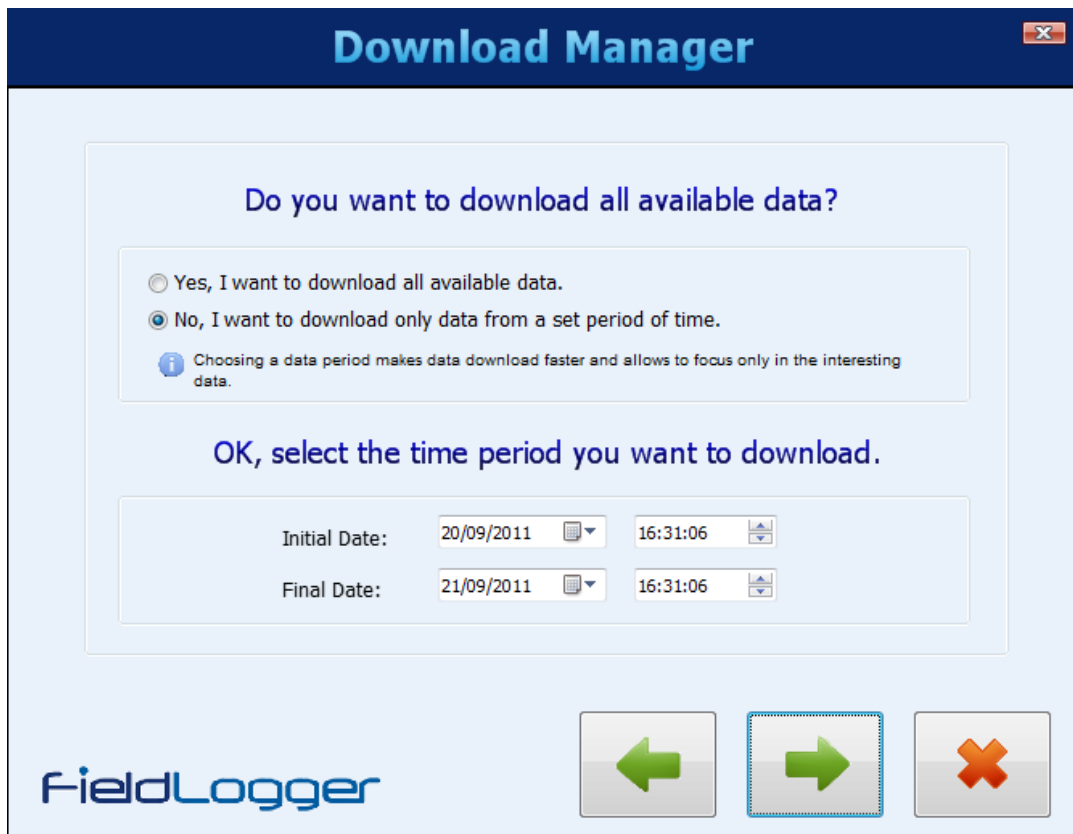
When selecting to download data directly from **FieldLogger**, a window will pop up asking for the connection mode to the equipment. One of these interfaces can be selected to download data: Ethernet (Modbus TCP) interface, USB (device) interface or RS485 (Modbus RTU) interface.



After the connection is done, next screen will show some information of the equipment (very useful to assure that you are accessing the right equipment, mostly when the download is done via Ethernet/Modbus TCP or RS485/Modbus RTU and there are many **FieldLogger's** in the network). Then the **FieldLogger** memory where logged data is (internal flash or SD card) must be chosen.



In case you selected to download data from the device SD card, next screen will ask the desired time period of the logging data. You can download all memory data (in case of SD cards, the amount of data can be huge and take a long time to download) or data just from a certain period of time.



In the next screen, you must confirm the data base folder (folder where all data should be stored in your computer or in the network) and choose whether downloaded data should be deleted from **FieldLogger** memory or should be kept there.

Next step is transferring data from **FieldLogger** to data base folder. By clicking on the green arrow button in order to proceed, the download of logged data will start and a progress bar will be displayed in order to indicate the download progress. Once it is ready, a new screen will be opened for data visualization/export (the same described in the "Download Manager", as follows).

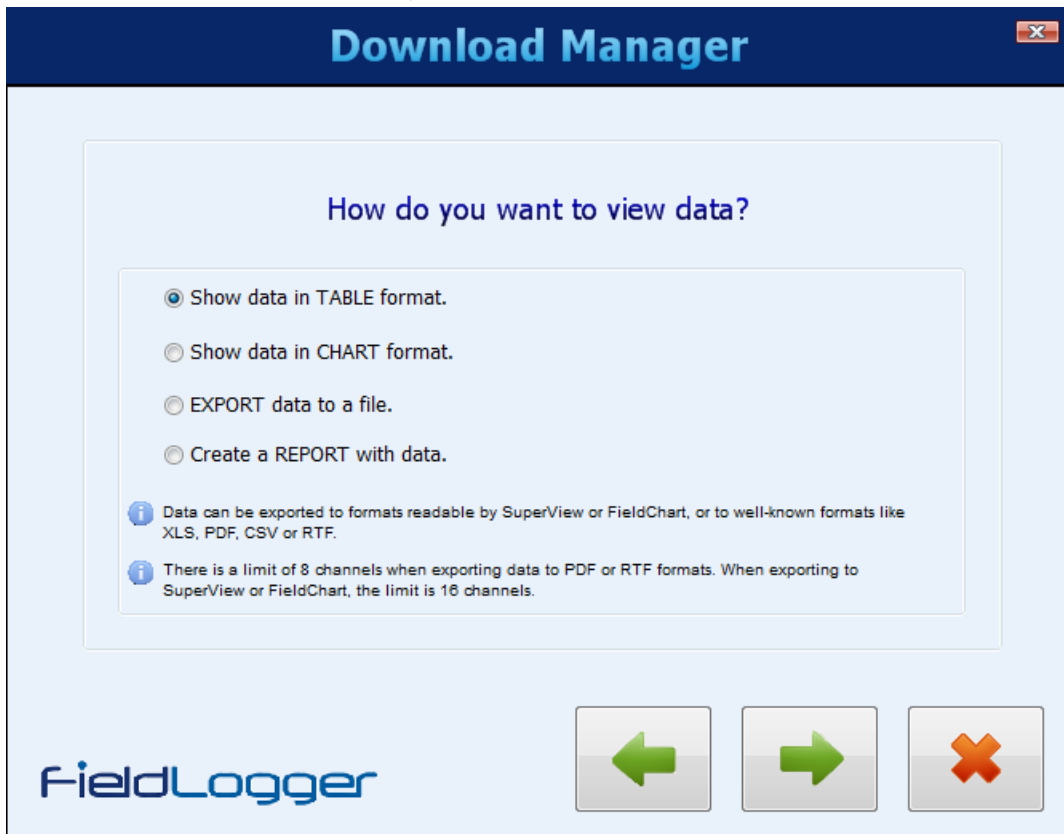
DOWNLOAD MANAGER

Download management is the choice of the desired viewing format and the desired data to be viewed.

There are two ways of performing this procedure: using or not the "wizard" format, which is a step-by-step proceeding created to make all the process more intuitive. Although this step-by-step proceeding is preferred, mainly to new users, the procedure used in previous versions (before 1.10) was kept.

USING STEP-BY-STEP (WIZARD)

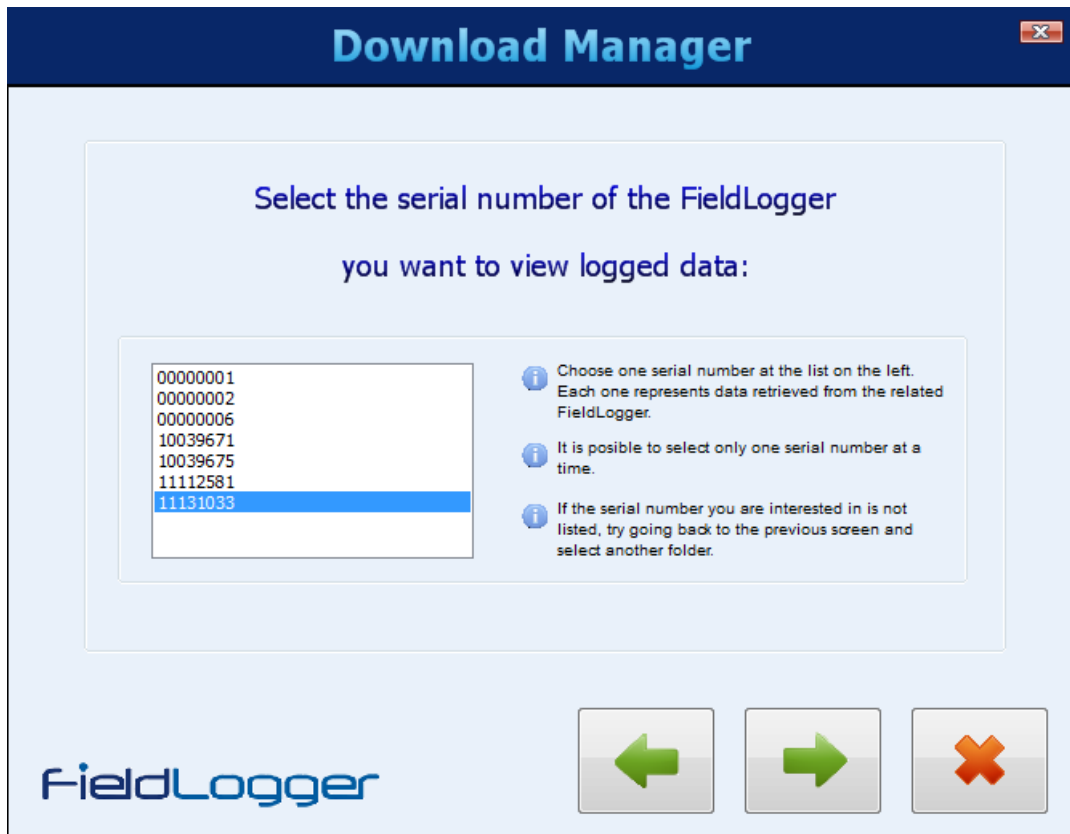
First of all, user must choose the way data will be processed. The available ways include viewing in table format, viewing in chart format, export data to a well-known file type and creation of a report with the desired data.



In the next screen, the database folder, where all **FieldLogger's** have their logging data saved, must be confirmed.



In the next screen, user must select which *FieldLogger* data would like to be viewed. Selection is done by their serial number.



After that, the desired time period must be selected.



At last, user must choose which channels must be viewed or exported, as well as the number of decimal places for the channels.



Table format view

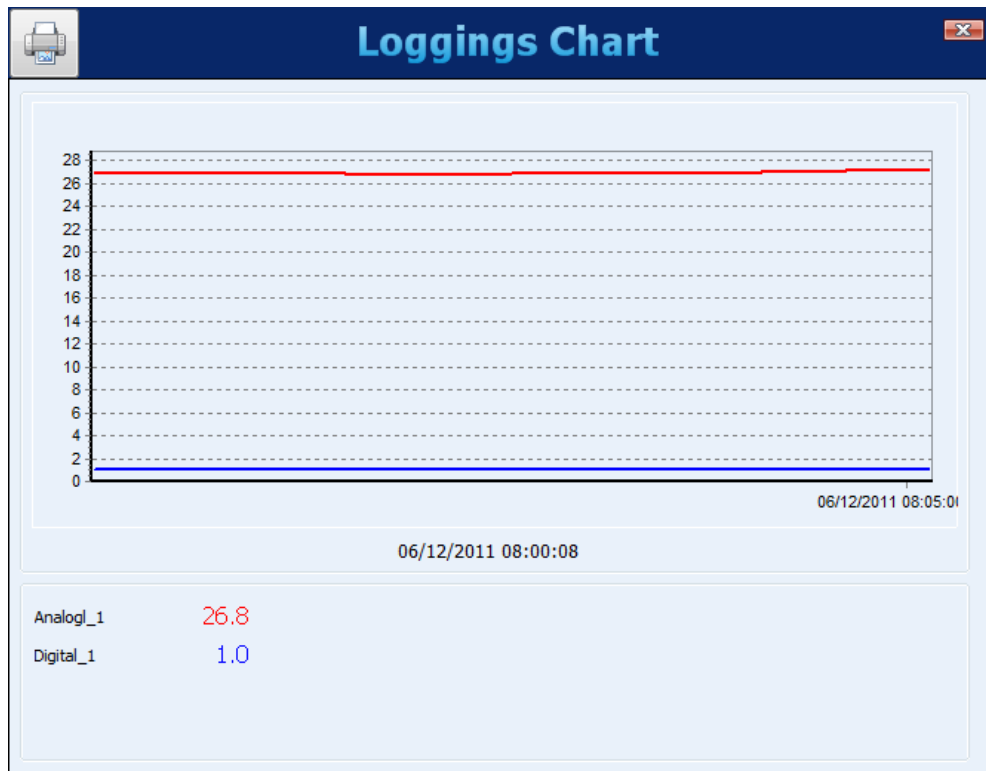
This kind of view shows data in a table sorted by time, with oldest data first. There are a few buttons for navigation in the upper side, where user can forward or back one screen, a hundred screens or go to the beginning or end of data. In order to view data in this format, no more than 16 channels can be viewed.

	TimeStamp	BoilerTemp	Furnace	Furnace1_Door
1	2010/12/09 14:28:26.437900	26,077974319458	-1,98537170886993	1
2	2010/12/09 14:28:26.442900	26,077974319458	-1,98537170886993	1
3	2010/12/09 14:28:26.447900	26,077974319458	-1,98537170886993	1
4	2010/12/09 14:28:26.452900	26,077974319458	-1,98537170886993	1
5	2010/12/09 14:28:26.457900	26,077974319458	-1,98537170886993	1
6	2010/12/09 14:28:26.462900	26,077974319458	-1,98537170886993	1
7	2010/12/09 14:28:26.467900	26,077974319458	-1,98537170886993	1
8	2010/12/09 14:28:26.472900	26,077974319458	-1,98537170886993	1
9	2010/12/09 14:28:26.477900	26,077974319458	-1,98537170886993	1
10	2010/12/09 14:28:26.482900	26,077974319458	-1,98537170886993	1
11	2010/12/09 14:28:26.487900	26,077974319458	-1,98537170886993	1
12	2010/12/09 14:28:26.492900	26,077974319458	-1,98537170886993	1
13	2010/12/09 14:28:26.497900	26,077974319458	-1,98537170886993	1
14	2010/12/09 14:28:26.502900	26,077974319458	-1,98537170886993	1
15	2010/12/09 14:28:26.507900	26,077974319458	-1,98537170886993	1
16	2010/12/09 14:28:26.512900	26,077974319458	-1,98537170886993	1
17	2010/12/09 14:28:26.517900	26,077974319458	-1,98537170886993	1
18	2010/12/09 14:28:26.522900	26,077974319458	-1,98537170886993	1
19	2010/12/09 14:28:26.527900	26,077974319458	-1,98537170886993	1
20	2010/12/09 14:28:26.532900	26,077974319458	-1,98537170886993	1

Viewing logged data in table format

Chart format view

This kind of view shows data in chart format. Passing the mouse over the chart shows the instantaneous values of each viewed channel at the bottom part of the screen. In order to view data in this format, no more than 16 channels can be viewed.



Viewing logged data in chart format

There is a button on the upper left corner that allows users to print the chart.

Data export

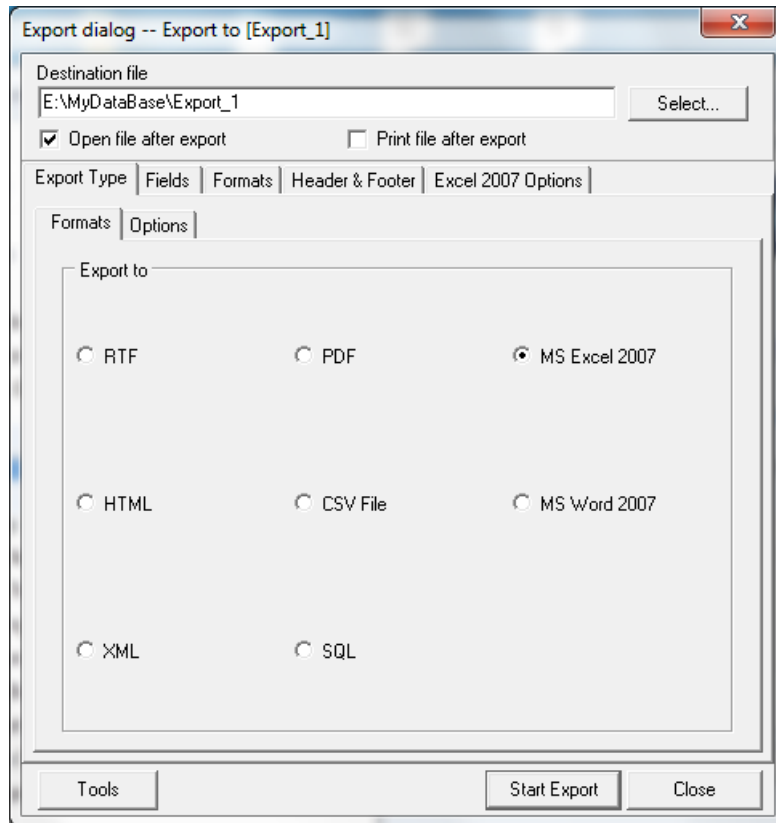
To export the selected data, you must click on the "Export" button. After a prior processing, a window will appear where you must select the destination folder, the file name and the file extension to be exported.

The screenshot shows an "Export" dialog box with the following fields and options:

- Destination Folder:** E:\MyDataBase
- File Name:** Export
- File Format:**
 - Other formats
 - SuperView
 - Field Chart
- Include Milliseconds
- Milliseconds Separator: .
- Buttons: OK, Cancel

When selecting the "Other Formats" option, a second screen will show up, where it will be possible to choose some parameters related to the chosen format: RTF, HTML, XML, PDF, CSV, SQL, XLSX or DOCX.

For exporting in “SuperView” or “FieldChart” format, there is a top limit of 16 channels. For exporting in “PDF” or “RTF” format, there is a top limit of 8 channels.



Upon completion of the export process, a window is displayed showing its success.



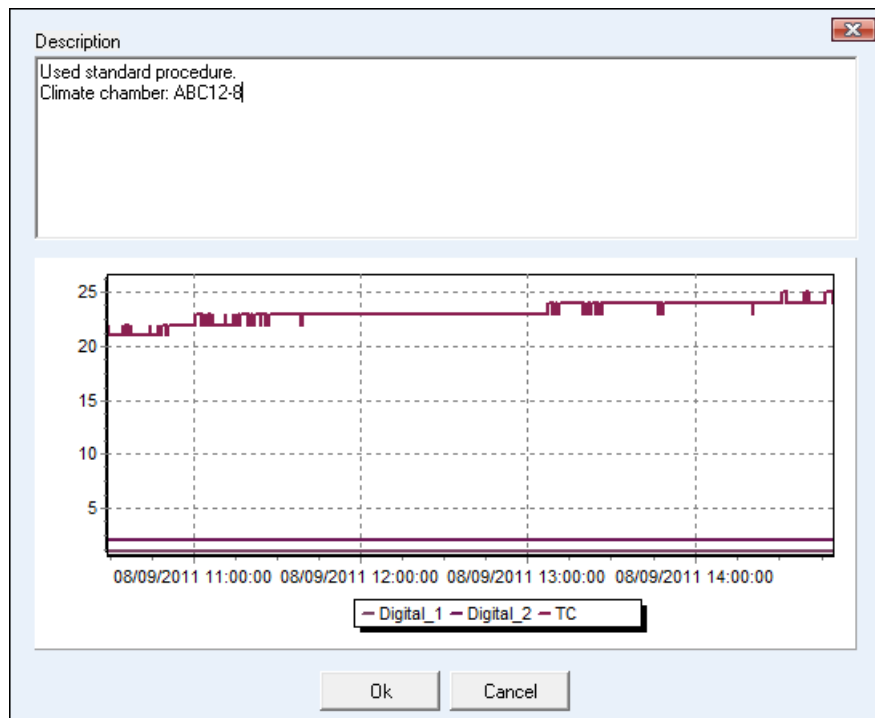
Report generation

The file name and destination folder must be entered. Additionally some fields that will be used in the report must be filled, like report author name, company name and report title. An image can also be selected to be presented in the report.

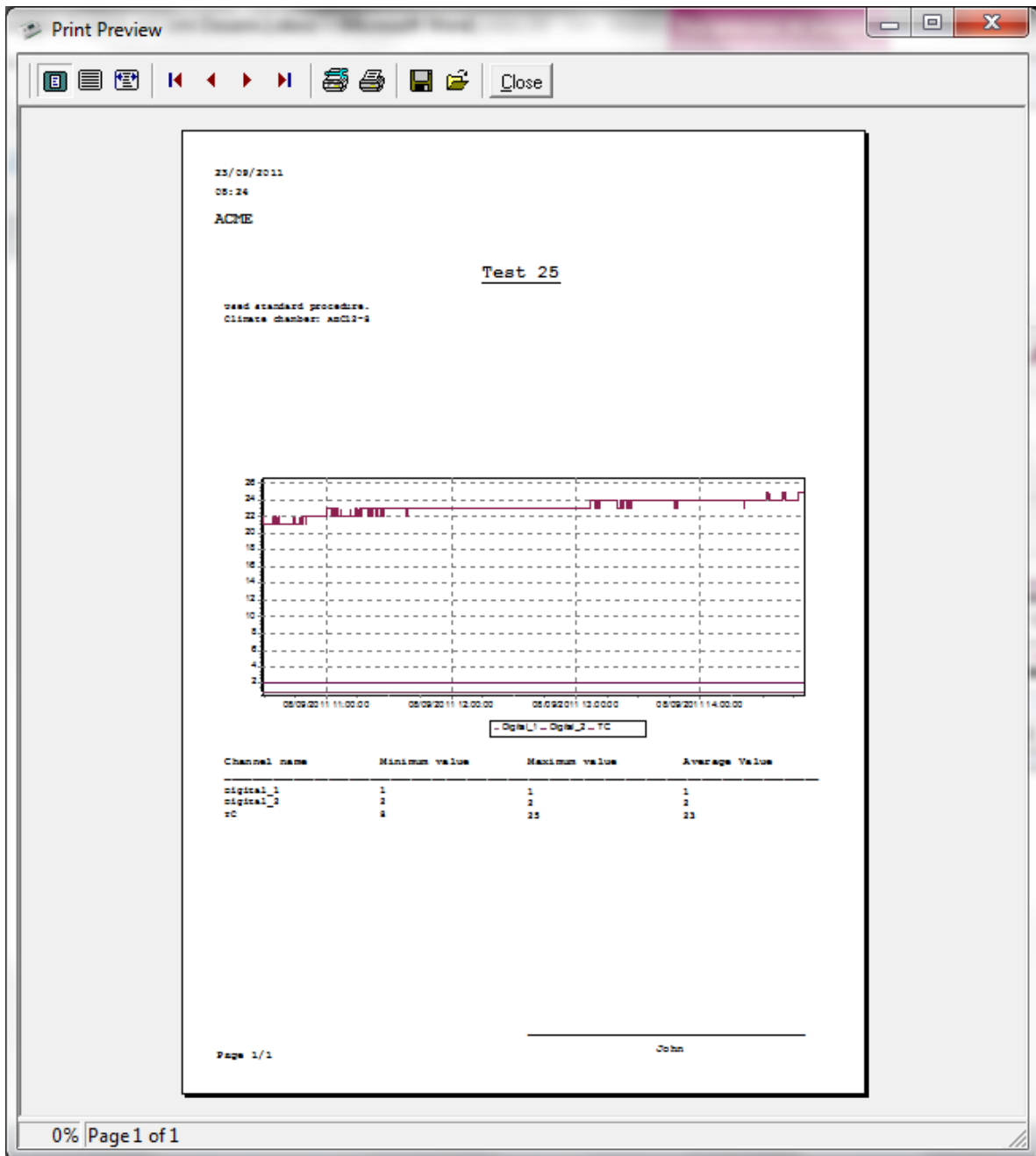
The 'Report' dialog box is shown with the following details:

- Destination Folder:** C:\
- File Name:** Report
- Report Info:**
 - Author: John
 - Company: ACME
 - Title: Test 25
- Image Placeholder:** A box containing the FieldLogger logo with the text 'Click on the image to insert a logo.'
- Buttons:** OK (green checkmark) and Cancel (red X).

When clicking on the "OK" button, data is processed (a progress bar is showed at the bottom part of the screen) and, when ready, the chart with data from the desired period is viewed. On this moment, some comment lines can be added to be part of the final report.



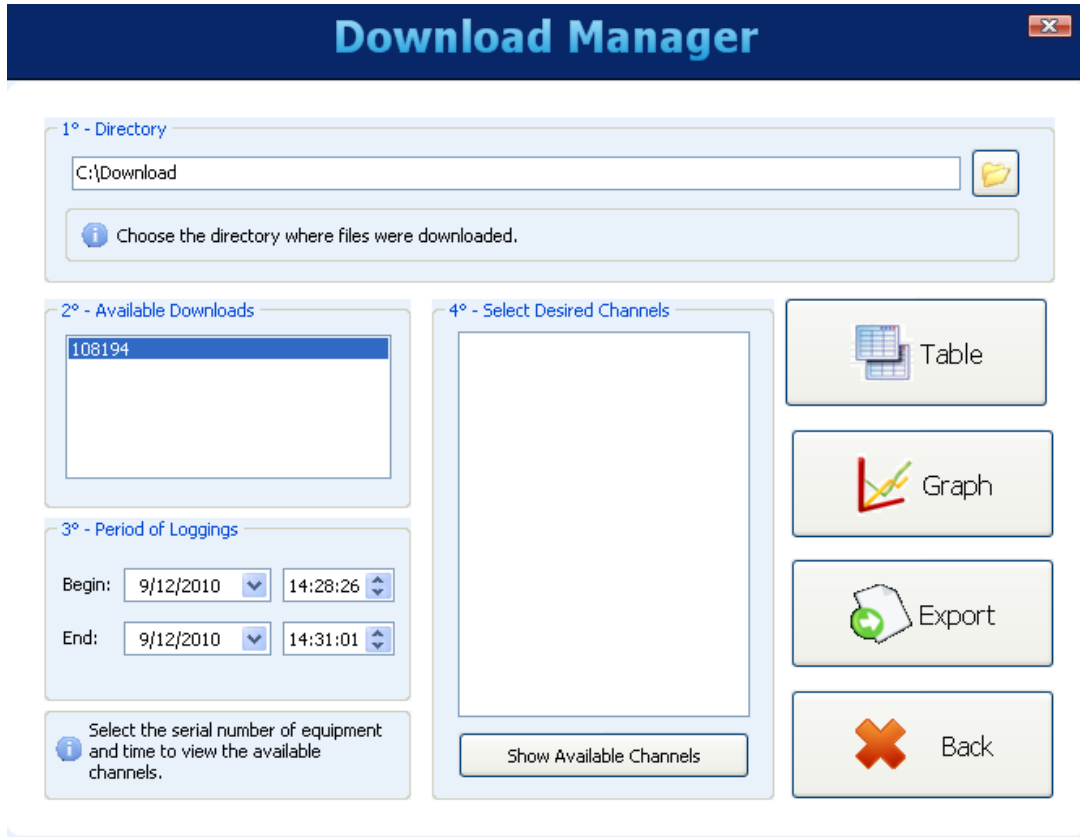
At the end, clicking on the "OK" button will generate and show the report. This report can be printed or saved to a file for later access.



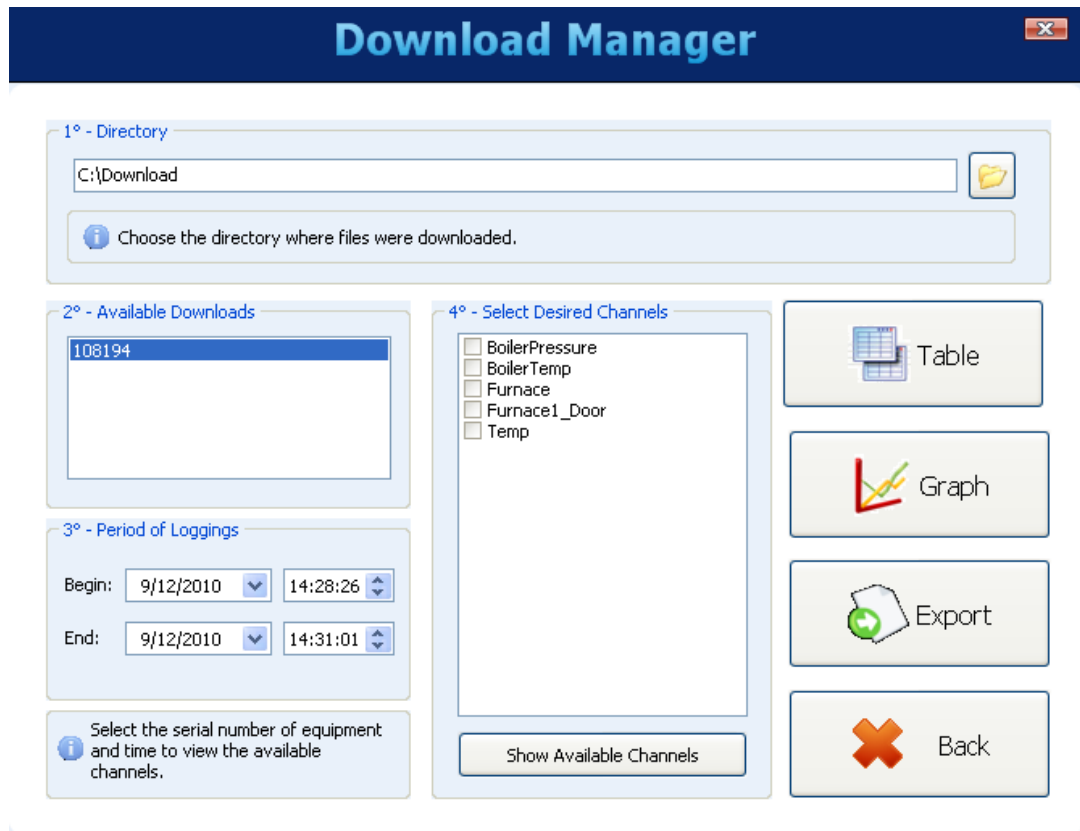
NON STEP-BY-STEP

In the previous versions of the configuration software, this was the only available procedure and it was kept for compatibility reasons.

The proper procedure is to select the source folder of the logged data (logging database). In the "available downloads" field will be displayed all devices that have downloaded data available.



You must choose, through the respective serial number, the equipment that has data of interest at this time. After that, you must define the time period of interest and click on "Show available channels".



Then, select which channels, among those available, are of interest.

Download Manager ✖

1° - Directory

 📁
Choose the directory where files were downloaded.

2° - Available Downloads

108194

4° - Select Desired Channels

- BoilerPressure
- BoilerTemp
- Furnace
- Furnace1_Door
- Temp

Show Available Channels

Table

Graph

Export

Back

3° - Period of Loggings

Begin:

End:

Select the serial number of equipment and time to view the available channels.

Finally, the chosen channels can be viewed in several ways.

Loggings Table ✖

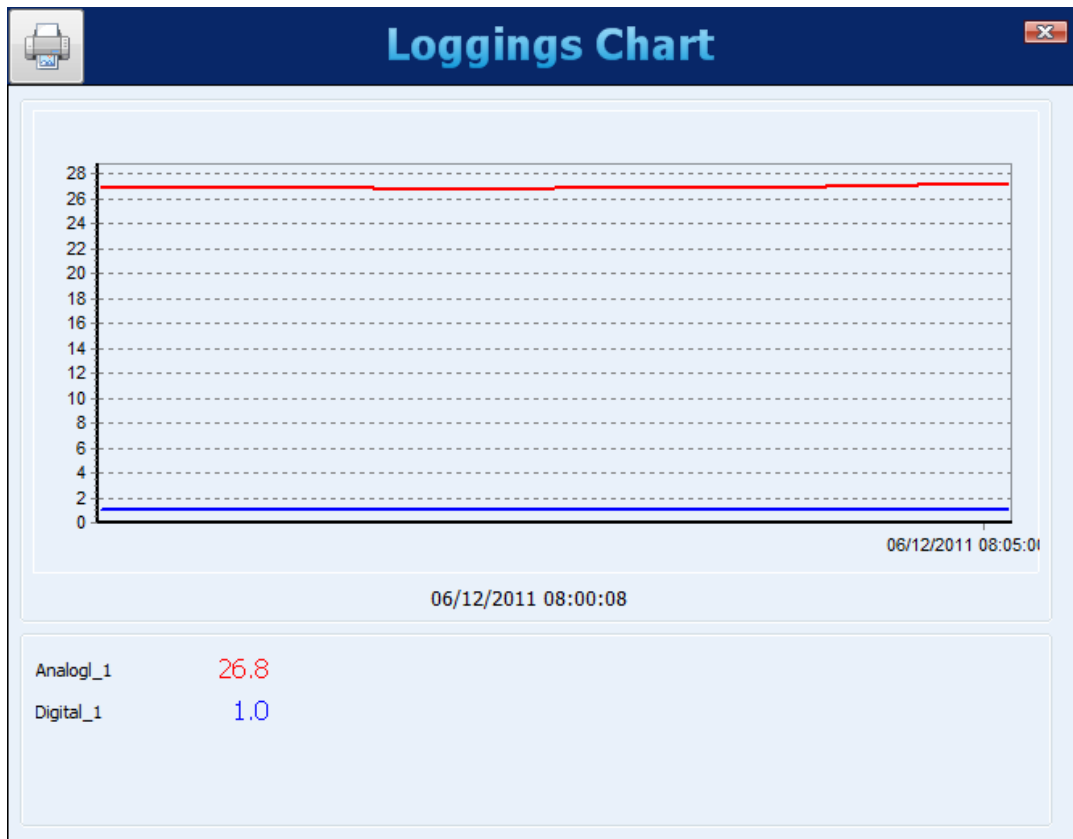
⏪
⏴
⏵

1 de 1550

⏴
⏵
⏪

	TimeStamp	BoilerTemp	Furnace	Furnace1_Door
1	2010/12/09 14:28:26.437900	26,077974319458	-1,98537170886993	1
2	2010/12/09 14:28:26.442900	26,077974319458	-1,98537170886993	1
3	2010/12/09 14:28:26.447900	26,077974319458	-1,98537170886993	1
4	2010/12/09 14:28:26.452900	26,077974319458	-1,98537170886993	1
5	2010/12/09 14:28:26.457900	26,077974319458	-1,98537170886993	1
6	2010/12/09 14:28:26.462900	26,077974319458	-1,98537170886993	1
7	2010/12/09 14:28:26.467900	26,077974319458	-1,98537170886993	1
8	2010/12/09 14:28:26.472900	26,077974319458	-1,98537170886993	1
9	2010/12/09 14:28:26.477900	26,077974319458	-1,98537170886993	1
10	2010/12/09 14:28:26.482900	26,077974319458	-1,98537170886993	1
11	2010/12/09 14:28:26.487900	26,077974319458	-1,98537170886993	1
12	2010/12/09 14:28:26.492900	26,077974319458	-1,98537170886993	1
13	2010/12/09 14:28:26.497900	26,077974319458	-1,98537170886993	1
14	2010/12/09 14:28:26.502900	26,077974319458	-1,98537170886993	1
15	2010/12/09 14:28:26.507900	26,077974319458	-1,98537170886993	1
16	2010/12/09 14:28:26.512900	26,077974319458	-1,98537170886993	1
17	2010/12/09 14:28:26.517900	26,077974319458	-1,98537170886993	1
18	2010/12/09 14:28:26.522900	26,077974319458	-1,98537170886993	1
19	2010/12/09 14:28:26.527900	26,077974319458	-1,98537170886993	1
20	2010/12/09 14:28:26.532900	26,077974319458	-1,98537170886993	1

Viewing logged data in table format



Viewing logged data in chart format

There is a button on the upper left corner that allows users to print the chart.

To export the selected data, you must click on the “Export” button. After a prior processing, a window will appear where you must select the destination folder, the file name and the file extension to be exported.

Export

Destination Folder
C:\Download

File Name
Export

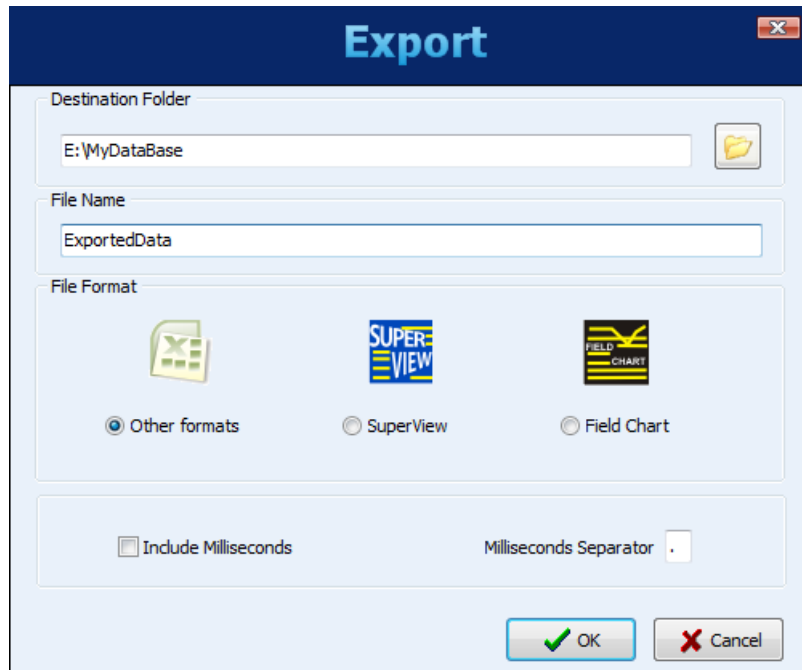
File Format

PDF
 RTF
 SuperView
 CSV
 XLS
 Field Chart

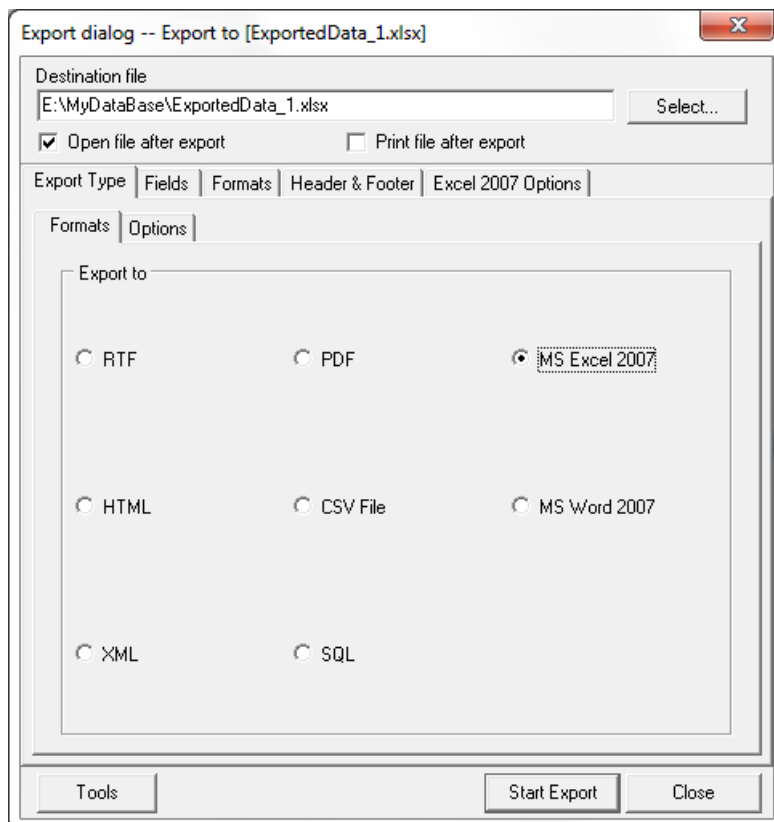
Include Milliseconds
 Milliseconds Separator .

OK Cancel

Since configuration software version 1.50, the exporting process was improved, providing more control over the fields and formats of the exportation. The basic window with the format choice became different:



Whenever choosing the “Other formats” options, a second window pops up, allowing the choice of the type of the file and many other options.



Upon completion of the export process, a window is displayed showing its success.



PREFERENCES

In the Preferences screen you can change the way the software application is started, adapting it to the procedure that is desired. The configurable options are:

- Do Nothing: Normal behavior of the software. You will see the initial application screen where you may select what to do.
- Read Configuration: The application will automatically open the connection screen and then execute the reading of the parameters configured in the equipment to which it was connected.
- Open Last Configuration: The application will read the last used configuration file and show it in the configuration screen, remaining disconnected from any equipment (you can connect using the appropriate button). If there is no last file, the software will indicate the error and display the initial screen.
- Download Logging Data: It will open the screen where you can choose what type of download will be performed.
- Open Diagnostics Screen: It will open the connection screen, and will make the reading of the connected equipment.

On this screen you can also change the language that the software will adopt as default.

The screenshot shows the 'Preferences' dialog box with the 'Change passwords' tab selected. The 'On Startup' section has three radio buttons: 'Do Nothing' (selected), 'Read Configuration', and 'Open Last Configuration'. The 'Download Logging Data' and 'Open Diagnostics Screen' options are also present but not selected. The 'Default Language' is set to 'ENGLISH' in a dropdown menu. The 'Splash Form' section has a checkbox for 'Show Splash form' which is unchecked. At the bottom, there are 'OK' and 'Cancel' buttons.

PASSWORD PROTECTION

It is possible to protect the access to the equipment by using passwords. You can register a password for configuration and another one for data download. First one protects the equipment from undesired changes in its configuration and the second one does not allow data to be downloaded by unauthorized people. In order to remove the need of a password to access the equipment, simply leave the new passwords fields blank.

The screenshot shows the 'Change passwords' tab in the 'Preferences' dialog box. It features a padlock icon. Under 'Enter current passwords:', there are two input fields for 'Configuration password' and 'Download password'. Under 'Enter new passwords:', there are two input fields for 'Configuration password' (with masked characters) and 'Download password'. An information icon and text state: 'Leave new passwords blank to remove them.' At the bottom, there are 'Change passwords' and 'Close' buttons.

This property is available since firmware version 1.40. **FieldLogger** leaves factory with no passwords set.

COMMAND-LINE OPERATION

FieldLogger Configurator has a new capability. It can now be called with “command-line” parameters, which means it can be used to download and export data by other applications.

It is advisable to create a batch file (.bat) to help organize the desired parameters. Once this batch file is done, it can be called (executed) from any other software in order to run the desired tasks, which include:

- Download data from the device.
- Get data from a folder where data has already been downloaded to.
- Export downloaded data to a file.
- Export data from the **FieldLogger** data base to a file.
- Create a report with logged data.

Some parameters are sent in the command-line, others are read by the INI files of the Configurator. So, it is important that you perform the desired action with the Configurator at least once before trying to make it by the command-line. It assures you that the method you are about to use actually works, and it saves the needed parameters in the INI file as well, so they can be used later.

Parameters order is important! Do not try to use them in any order but the one shown here.

Parameters examples are shown inside quotation marks (“”), but there must be no quotation marks in the real file.

BATCH FILE

The batch file is exactly the same of those ancient DOS batch files. Its name must have no more than 8 characters, a dot (.) and 3 more for its extension (“bat”).

In the file, we separate the parameters in four parts:

1. PART1 – Action type
2. PART2 – Connection mode
3. PART3 – Action parameters
4. PART4 – Export parameters

All parameters are separated by semicolons.

ACTION TYPE

The following actions are allowed:

- “1” to download and export data.
- “2” to export data from the data base.
- “3” to download data without exporting it.

CONNECTION MODE

The connection mode can be:

- “1” to connect by Ethernet/Modbus TCP. In this case, it will read the port and reconnection time from the Configurator “INI” file, which means that it should have been done before in the Configurator “normal” operation. This option requires the IP address as an additional parameter. From software version 1.30 on, there must be also included port number and time out in miliseconds. From software version 1.40 on, **FieldLogger** Modbus address (typically 255) has to be included as well. Example: “1;10.51.10.78;502;3000;255;”
- “2” to connect by the USB cable. This option requires the COM port as an additional parameter. Example: “2;3;”
- “3” to connect by the RS485/Modbus RTU interface. In this case, it will read the baud rate, parity, stop bits and timeout from the Configurator “INI” file, which means that it should have been done before in the Configurator “normal” operation. This option requires the COM port and the Modbus address as additional parameters. Example: “3;2;7;”
- “4” to get data from a folder. This option should be used when data was already downloaded from the **FieldLogger** through a USB flash drive, FTP or when reading directly from the device SD card (plugged in your computer). This option requires the folder path as an additional parameter (the folder with the device serial number must be included). Important: there must be no blank spaces in the path! Example: “4;E:\11097831;”

When the chosen Action is “2” (export only, no download), the parameter “NULL” must be used to indicate that no connection is needed. Example: “NULL;”

ACTION PARAMETERS

These parameters are directly related to the option chosen for the Action. The data base folder is read by the Configurator INI file, so be sure to set it in the software before trying to use it by the command-line.

- For Action “1”, we need the following additional parameters (their order should be respected):
 1. Data source. It can be: “0” when downloading data from device internal flash, “1” when downloading from device SD card and “2” when getting data from a folder in the computer/network (connection mode “4”).
 2. Time period. It can be: “0” to download all its data or any other integer “X” number to download data from the last “X” days.
 3. Erase option. It can be: “0” will keep data in the original memory, “1” will erase downloaded data from the original memory.
 4. Serial number. Device serial number should be placed here.
 5. Download password (needed for firmware versions 1.40 or higher). Registered password for downloads should be placed here. A “NULL” string must be used if there no password is used.
 - Example: “0;0;1;11097831;1234;”
- For Action “2”, we need the following additional parameters (their order should be respected):
 1. Serial number. Device serial number should be placed here.
 2. Time period. It can be: “0” to download all its data or any other integer “X” number to download data from the last “X” days.
 - Example: “11097831;3;”
- For Action “3”, we need the following additional parameters (their order should be respected):
 1. Data source. It can be: “0” when downloading data from device internal flash, “1” when downloading from device SD card and “2” when getting data from a folder in the computer/network (connection mode “4”).
 2. Time period. It can be: “0” to download all its data or any other integer “X” number to download data from the last “X” days.
 3. Erase option. It can be: “0” will keep data in the original memory, “1” will erase downloaded data from the original memory.
 4. Download password (needed for firmware versions 1.40 or higher). Registered password for downloads should be placed here. A “NULL” string must be used if there no password is used.
 - Example: “1;7;0;1234”

EXPORT PARAMETERS

These parameters are related to file export. The target folder for the exported files, as well as the Author, Company and Title fields for the reports, are read by the Configurator INI file, so be sure to set it in the software before trying to use it by the command-line.

- File name with no extension or blank spaces.
- File type. Use “1” for PDF, “2” for CSV, “3” for RTF, “4” for XLS, “5” for SuperView, “6” for FieldChart, “7” for creating a report, “9” for SQL, “11” for HTML, “12” for DOCX, “13” for XLSX and “14” for XML.
- Number of decimal places to be used for channels values. Valid values: 0 to 6.
- Example: “test_report;2;1;”

When the chosen Action is “3” (download only, no export), the parameter “NULL” must be used to indicate that no export is needed. Example: “NULL;”

FIELDLOGGER OPERATION

ANALOG INPUTS

FieldLogger has eight channels for reading analog variables. The types of accepted signals and sensors are the following: thermocouples J, K, T, E, N, R, S and B; RTDs Pt100 and Pt1000; 0 to 50 mV; 0 to 60 mV; 0 to 20 mV; -20 to 20 mV; 0 to 5 V; 0 to 10 V; 4 to 20 mA and 0 to 20 mA.

The accuracy of these types of signals is described in the *Specifications* section. The connection of these signals is described in the *Connections and Installation* section.

In these inputs, we use an analog/digital converter (A/D) with high resolution (24 bits) and accuracy. In the desired scan interval, all the analog channels enabled will be read. The ratio between the number of channels enabled and the scan time is limited up to 1000 readings per second. In other words, we can have one channel being read 1000 times per second, two channels being read 500 times per second and so on. So, the A/D converter will work faster in order to cope with the desired channels scan.

The A/D converter has the property of having a better signal-noise ratio when operating at low speeds (larger scan intervals), as well as better immunity to noise from the power grid and a higher effective resolution. In such way, in order to obtain better results in the analog inputs reading, it is strongly recommended to use the largest possible scan interval for the application. In the same thought, it is recommended to disable all the channels that are not necessary, because the increase in the number of enabled channels causes the A/D converter to work faster in order to cope with the scan rate configured by the user.

Each type of input signal has a valid range of measurement (detailed in the *Specifications* section of this manual). However, the equipment usually can measure signals that exceed the limits of this range. How far beyond the valid range will depend on the type of the configured input and may vary from device to device.

The following table outlines what to expect in the indication of **FieldLogger** depending on the signal applied at the input, for each type of configured input.

INPUT TYPE	CONDITION OF INPUT SIGNAL	INDICATION
Thermocouples: J, K, T, E, N, R, S and B	Within the range	Value read from input
	Open thermocouple	Value of configured error
	Just above the upper limit	Value read from input *
	A little below the lower limit	Value read from input *
	Far above the upper limit	Value of configured error
	Well below the lower limit	Value of configured error
Pt100 and Pt1000	Within the range	Value read from input
	Pt100/Pt1000 with one or more wires disconnected	Value of configured error
	Just above the upper limit	Value read from input *
	A little below the lower limit	Value read from input *
	Far above the upper limit	Value of configured error
	Well below the lower limit	Value of configured error
Voltage (mV): 0 to 50 mV, 0 to 60 mV, 0 to 20 mV and -20 to 20 mV	Within the range	Value read from input
	Disconnected signal	Value of configured error
	Just above the upper limit	Value read from input *
	A little below the lower limit	Value read from input *
	Far above the upper limit	Value of configured error
	Well below the lower limit	Value of configured error
Voltage (V): 0 to 5 V and 0 to 10 V	Within the range	Value read from input
	Disconnected signal	Value close to 1.8 V
	Just above the upper limit	Value read from input *
	A little below the lower limit	Value read from input *
	Far above the upper limit	Value of configured error
	Well below the lower limit	Value of configured error


INPUT TYPE	CONDITION OF INPUT SIGNAL	INDICATION
Current (mA): 4 to 20 mA and 0 to 20 mA	Within the range	Value read from input
	Disconnected signal	4 to 20 mA: Value of configured error 0 to 20 mA: 0 mA
	Just above the upper limit	Value read from input *
	A little below the lower limit	4 to 20 mA: Value read from input * 0 to 20 mA: it is not possible to decrease besides the inferior limit
	Far above the upper limit	Value of configured error
	Far below the lower limit	4 to 20 mA: Value of configured error 0 to 20 mA: it is not possible to decrease besides the inferior limit

(*) **Note:** The indication of the analog channel is still a bit beyond the limits specified for the selected input type. However, in this condition, the accuracy is not guaranteed.

Table 01 - Measurement and indication of the **FieldLogger** input types

For each channel, you have to choose the digital filter to be used in this channel reading, with valid values between "0" (no filter) and "20" (maximum filter): the higher the value of the filter is, the lower are there fluctuations read in the input, but the slower is the channel response to changes in the input signal.

There is also the feature of inserting up to 10 points for each channel in order to correct distortions in the reading of these channels at these points. We call this feature "custom calibration," because it allows the user to adjust the indication at the desired points, resetting to zero the error on these points. Between the inserted points, the adjustment is done linearly, depending on the entered values. It is important to point out that the insertion of custom calibration points is optional, available only to those who want to adjust the indication with a local standard, because **FieldLogger** already comes fully calibrated from the factory.

	Whenever you change the input type, make sure that the custom calibration points of the previous input are deleted!
---	---

For each channel, you must assign a unique name (tag), which will be used to reference the channel. You should also choose the type of input (sensor) that will be connected to that channel. In addition, you can assign the unit for the measured value: when temperature sensors (Pt100, Pt1000 or thermocouples) are involved you must choose between Centigrade (°C) and Fahrenheit degrees (°F); when linear sensors (voltage or current) are involved, you can type the desired unit.

In the case of linear input types, you should choose what the indication range of the channel is, in other words, what the channel must indicate when the input is at its minimum value and what it should indicate when at its maximum value (minimum and maximum values considering the working range of the **FieldLogger** for the selected input type). Example: selecting the 4-20 mA input type connected to a 0 to 2 bar pressure transmitter. In this case, we must choose the minimum value in the configuration of the input "0.0" and the maximum value "2.0". All the available resolution and accuracy will be contained in the selected range.

When using any equipment on analog inputs that are connected to the power network (for example: thermocouples or voltage simulator), it is recommended not to use the USB interface for communicating. In some cases, it was noticed the occurrence of noise and offsets in the readings due to the influence of the USB cable connection, probably due to ground loops.

DIGITAL INPUTS/OUTPUTS


FieldLogger has eight digital channels that can be individually configured as inputs or outputs.

Channels configured as inputs, if enabled, may be logged in memory, used as alarm inputs and as operands of virtual channels. Channels configured as outputs are "open-drain" type and may be triggered by alarms or triggered via external Modbus commands.

The digital inputs have two (floating point) values associated with their logic states during the equipment configuration. Depending on the input's current logic state ("0" is equivalent to a low voltage or a closed contact in the input; "1" is equivalent to a high voltage or an open contact in the input), this corresponding value is used by the virtual channels, alarms and logs.

The digital outputs configured to be controlled by the alarms cannot be triggered by external Modbus commands. Likewise, the outputs configured to be controlled by external Modbus commands cannot be used by the alarms.

The outputs controlled by external commands can be used, for example, as control outputs or alarm outputs of SCADA software or PLCs.

	The digital inputs/outputs terminals are not isolated from the analog inputs terminals! Do not use analog and digital signals coming from the same voltage source; this will cause the equipment to malfunction.
---	---

COUNTINGS

From firmware version 1.10 on, it is possible to perform pulse counting at the digital inputs of the **FieldLogger**. Counting resolution is 32-bit, which means that each input can count from “0” up to $(2^{32} - 1 =)$ “4294967295”. When reaching the maximum value, next counted pulse will cause a roll-over and will reset the counting to zero.

The counting values can be accessed from Modbus registers (see the “FieldLogger – Modbus” document) and can also be copied to a virtual channel, where they can be logged to memory or used by the alarms, for example. When applying a new configuration in the digital channels, the counting’s of all of the digital channels are reset to zero.

Counting’s can be zeroed by writing it in the related Modbus registers.

Counting values are persistent, which means they will remain even when FieldLogger is turned off. Whenever it is turned on again, countings are restarted from the values existent right before it was turned off.

OUTPUT RELAYS

FieldLogger has two relay type outputs (**RL1** and **RL2**) which can act as **Alarms** or **Digital Outputs**.

When configured as Alarms, they act according to the configuration adopted for the alarms. When configured as Digital Outputs, they are controlled remotely via Modbus commands (via RS485, USB or Ethernet).

RS485 INTERFACE

FieldLogger RS485 interface can be enabled or disabled. When disabled, it does not impact the traffic that may exist on the data bus. When enabled, it can be configured to operate as a Modbus RTU master or as a slave.

Slave

When operating as a Modbus RTU slave, the equipment makes the values of the channels available to be accessed by the master of the Modbus network, either being a PLC, a SCADA application or any other device.

Master

When operating as a Modbus RTU master, it allows data from other devices on the bus to be read by **FieldLogger** and used in loggings, alarms, virtual channels or simply made available via another interface (Ethernet, for example). Please, see the "Remote Channel" section for details of how to implement a Modbus RTU network with **FieldLogger** in the master role.

From firmware version 1.10 on, it can work as a gateway between a Modbus TCP network and a Modbus RTU network. This way, all Modbus TCP requests received by **FieldLogger** with an identifier which is not “255” will be forwarded to the Modbus RTU network, assuming that this request was addressed to a slave located in this network. Modbus TCP requests received by **FieldLogger** with an identifier equals to “255” will be answered by the **FieldLogger** itself. This feature must be enabled in the Configurator software.

The RS485 interface can be configured to operate in the following speeds (baud rates): 1200, 2400, 4800, 9600, 19200, 38400, 57600 and 115200. Moreover, it can be configured to operate with one or two stop bits, and in the parities: even, odd and none.

Further details about the implementation of a Modbus devices network via RS485 can be found in "RS485 & RS422 Basics", available in the product CD.

D1	D	D+	B	Bidirectional data line.	Terminal 50
D0	D	D-	A	Inverted bidirectional data line.	Terminal 49
C			GND	Optional connection that improves communication performance.	Terminal 48

AUXILIARY RS485

FieldLogger auxiliary RS485 interface is in the DB9 connector which is located under **FieldLogger** cover. Its main function is to provide data to **FieldLogger** HMI, but from firmware version 1.20 on, it can be used as a generic interface, acting as a Modbus-RTU slave. Some further details can be seen in “HMI (Human-Machine Interface)” section.

As an interface to the HMI, it must be configured with baud rate 115200 bps, one stop bit and no parity.

As a generic interface, it can be configured to operate in the following baud rates: 1200, 2400, 4800, 9600, 19200, 38400, 57600 e 115200. Besides that, it can be configured to operate with one or two stop bits and with even, odd and no parity.

D1	D	D+	B	Bidirectional data line.	Pin 4
D0	D	D-	A	Inverted bidirectional data line.	Pin 8
C			GND	Optional connection that improves communication performance.	Pin 7

REMOTE CHANNELS



Function not available in models "FieldLogger – USB, 512k logs, RS485" and "FieldLogger – USB, 512k logs, RS485, 24 V".

FieldLogger can act as a master of a Modbus RTU network (please check the RS485 interface configuration), being able to read up to 64 registers from other devices (Modbus slaves) and using these registers as inputs in the virtual channels, alarms and loggings. Each one of these registers read from other slaves is called a "remote channel".

The equipment starts reading the channels in the same order that they were created at configuration time. It goes on reading all channels, respecting the times between commands, until it has read them all. When the scan interval has elapsed, it restarts the readings of all remote channels. In case the channels scan takes longer than the settled scan interval, it restarts the channels reading immediately.

If the slave takes longer than the configured time out to respond, this will be considered a communication error. In the same way, response packets with invalid CRCs or with times between bytes greater than those specified in the Modbus standard will be considered communication errors. In the occurrence of a communication error in a remote channel reading, it tries again until the configured number of attempts has been reached. If the error persists, the error value configured for the channel is assumed.

The whole communication flow can be monitored by the **FieldLogger** Tx and Rx LEDs. Whenever a command is sent to a slave, the Tx led turns ON. When the slave responds to the command, the Rx led turns ON. This way, during a normal **FieldLogger** scan of some slaves, Tx and Rx LEDs should flash alternately as many times as the number of the configured remote channels.

From firmware version 1.50 on, it is possible to assign a number of decimal places directly to the remote channels. This way it is not necessary to use virtual channels to view a remote channel which has one or more decimal places. For example, reading a temperature from a Modbus slave that has a decimal place in integer format, in other words, it is multiplied by "10" (25.7 °C is read as 257), it is possible to read "25.7" directly. In older versions, you had to create a virtual channel that received this remote channel and divided its value by 10, restoring the original temperature value. This virtual channel could then be used to replace the remote channel for logging, alarms or simple indication.

VIRTUAL CHANNELS

There are up to 128 virtual channels available in the **FieldLogger**. These channels are nothing more than channels whose values are the result of logical or mathematical operations. Depending on the selected operation, one or two operands will be necessary, defining that the operands are always other channels (analog, digital, remote or even virtual). All operands are in the "floating point" format, which allows a greater precision in the calculations by the use of several decimal places.

It is possible to "chain" several operations, causing the outcome of an operation to be the operand of another. If a channel used as operand is in an error condition, the resulting virtual channel will also assume its own error value. In other words, the error condition is passed on to the virtual channels that are dependent on a channel in error.

Constant values can be used through the "Constant" operation, where a value chosen by the user may be assigned to a virtual channel.

The following operations are available and can be used:

Operation	Number of Operands	Function
Constant	1	Assigns a value to the virtual channel. Example: VC = 123.67
Addition	2	It receives the addition from two channels. Example: VC = C1 + C2
Subtraction	2	Receives the subtraction from two channels. Example: VC = C1 - C2
Multiplication	2	Receives the multiplication from two channels. Example: VC = C1 * C2
Division	2	It receives the division from two channels. Example: VC = C1 / C2
Logical “And”	2	It receives “0” if at least one of the two channels is zero. It receives “1” if both channels are different from zero.
Logical “OR”	2	It receives “0” if at least one of the two channels is not zero. It receives “0” if both channels are equal to zero.
Logical “Exclusive OR”	2	It receives “1” if only one of the two channels is not zero. It receives “0” if both channels are equal to zero or if both are different from zero.
FloatToFloat	2	Transforms two 16-bit values in a “float”. Typically used when reading two Modbus registers (remote channels) from other device that, when combined, represent a floating point value.
Int32ToFloat	2	Transforms an integer 32-bit signaled value in a floating point value. The allowable range for the integer value (operand) is from -16777215 to 16777215. Values outside this range will suffer truncation.
Square Root	1	Receives the square root from the operand (source channel).
Exponentiation	2	Receives the result from the first high channel to the second channel. Example: VC = C1 ^{C2} . The value of the exponent is limited to the range of -120 to 120, and must necessarily be of the integer type (the decimal part shall be disregarded).
Count ¹	1	Copies the current counting value of the selected digital channel (operand) to this virtual channel. It uses only 24 bits, which means it can count up to “16777215” (most significant byte of the counting’s ignored).
Variation ²	1	At a configurable time rate (in seconds), shows the difference from the current channel value related to the previous time value. In other words, it has the value of the final time minus the value of the initial time. In case this operation is being performed in a digital channel, the variation of its countings will be computed.
Accumulation ²	1	Receives the accumulated value of the selected channel. At a configurable time rate (in seconds), gets the current channel value and sums to the accumulated amount.
ByteInv FloatToFloat ³	2	Transforms two 16-bit values in a “float”. It works just like the FloatToFloat operation, but each register has its bytes swapped (byte high ↔ byte low) right before the operation. Useful when the register read from a slave has a byte order (<i>endianness</i>) which is opposite to the one expected by FieldLogger .
ByteInv Int32ToFloat ³	2	Transforms an integer 32-bit signaled value in a floating point value. It works just like the Int32ToFloat operation, but each register has its bytes swapped (byte high ↔ byte low) right before the operation. Useful when the register read from a slave has a byte order (<i>endianness</i>) which is opposite to the one expected by FieldLogger .

(1) **Note 1:** Available from firmware version 1.10 on.

(2) **Note 2:** Available from firmware version 1.20 on.

(3) **Note 3:** Available from firmware version 1.40 on.

When an error occurs on any channel (for example, disconnected sensor in an analog channel), its configured error value is set to it. If this channel is used as an operand of a virtual channel, its error value will be detected and the outcome of the virtual channel will be its own configured error value, leading to a propagation of the error values. One exception is the operation “Int32ToFloat”, that does not propagate the error of the source channels (operands), because it is typically used in the conversion of two remote channels in a 32-bit value and, on this case, it would show an error every time one of the remote channels would have the error value (all values are valid – there is no error value that can be set outside of the valid range). The other exception is the “Accumulation” operation, that simply holds accumulation instead of displaying the error value.

Sample of chaining virtual channels in order to obtain more complex formulas

As an example, we will be using the formula for calculating the flow measurement using an orifice plate, which is very popular in the industrial instrumentation environment. The formula is the following:

$$Q = K \sqrt{\frac{\Delta P}{\rho}}$$

Where Q = flow

ρ = flow density

ΔP = differential pressure

K = constant that makes the appropriateness of units and dimensions involved

In this case, we will be considering that the differential pressure (ΔP) will be read as an analog channel (ChAnalog_1 = ΔP), with the limits configured for measuring the correct unit.

In the Configurator software, we must enter the following virtual channels:

VC1 = K ("constant" operation with the numeric value of K)

VC2 = ρ ("constant" operation with the numeric value of ρ)

VC3 = ChAnalog_1 / VC2 ("Division" operation)

VC4 = $\sqrt{\text{VC3}}$ ("square root" operation)

VC5 = VC1 x VC4 ("multiplication" operation)

As a result, VC5 has the flow value of Q.

USB INTERFACE

The **FieldLogger** has two USB interfaces: one USB device, used for the configuration, monitoring and data downloading, and one USB host, used for data download and firmware updates, if and when necessary.

USB DEVICE

The USB interface device is the preferential interface for the equipment configuration. It is the only interface that can never be disabled.

To access it, you should use the supplied USB cable. The "USB" led should light ON, indicating that the interface is ready for use. (On first access, it may be necessary to install the USB drivers on your computer. Whenever you have to do this, please check the "USB Driver Installation".)

The communication on this interface is Modbus RTU, just like as the slave interface RS485. The same commands and the same table of registers are available for this interface (please refer to the document "**FieldLogger** – Modbus").

USB HOST

The USB host interface can be used to download the logged data from either the internal flash memory or the SD Card (it will download the memory currently configured), via a USB flash drive.

In order to perform the data download with a USB flash drive, this option must have been enabled on the Configurator software. Such being the case, when you connect the USB flash drive in the USB host interface, the "USB" led should light ON, indicating that it has been correctly recognized. From then on, the transference of data to the USB flash drive is started and the "USB" led starts to flash quickly. When all data have been transferred, the "USB" led stops flashing and stays lit on, indicating that the USB flash drive can now be removed.

In case data download with a USB flash drive has been disabled, nothing will happen when you plug in a USB flash drive in the USB interface, not even the led will turn on!

There is an option to download all the memory and also the option to download data of a limited number of days. In the second case, we can still choose if we want to download the earlier or later data. Example: when configuring the download of the most recent four-day data, the machine scans the memory and transfers to the USB flash drive all logging data found from the last four days that actually have some logged data.

Remarks:

- Use a USB flash drive with enough space for all data that must be downloaded (preferably an empty USB flash drive).
- Depending on the volume of data and the busy rate of the **FieldLogger** processor, the download may require a long period of time. To optimize data download via USB flash drive, try to download data more frequently and set the Download Period option for a few days, which will reduce the data volume in each download.

Throughout the **FieldLogger** operation, while not downloading data to the USB flash drive, all different types of errors generate 3 blinks on the status led. When the USB flash drive is connected for download and an error occurs, it is indicated as shown in the table below:

BLINK NUMBER	ERROR
1	Not enough space on the USB flash drive
2	File not found
3	USB flash drive disconnected before the end of the download
4	Writing error in USB flash drive
5	Error in creating the path in the USB flash drive
6	Error in the opening of the download session: there is already an open session (configuration or download)

ETHERNET INTERFACE



Interface not available in models “**FieldLogger – USB, 512k logs, RS485**” and “**FieldLogger – USB, 512k logs, RS485, 24 V**”.

The **FieldLogger** Ethernet interface allows the connection of the equipment in Ethernet 10/100 Mbps networks. There are several services available for this interface, all enabled and configured individually, which gives **FieldLogger** a high degree of versatility.

Note: It is always recommended that when not needing an interface or a service anymore, these should be disabled.

For connection to the TCP-IP network, we can set a fixed IP or use DHCP (*dynamic host configuration protocol*, the protocol that allows for **FieldLogger** to have an IP number assigned by the network server). Furthermore, if desired, you can enable the DNS service, where in some services, instead of the IP number of the servers, you can configure your name (URL).

Note: **FieldLogger** does not have the processing capability of computers; therefore the switch port where it is connected (especially in data center monitoring applications) configuration should be as basic as possible, avoiding exaggerated traffic in the network where it is. This will greatly increase its performance, avoiding potential packet losses.

The following services are available:

MODBUS-TCP

FieldLogger can be enabled to communicate through Modbus-TCP protocol, widely used in SCADA systems. By enabling that functionality, **FieldLogger** will act as a Modbus-TCP server, allowing channel values, as well as status and configuration information, to be read and written by external software applications. Enabling the gateway functionality (assuming the device is configured as a Modbus-RTU/RS485 master), **FieldLogger** can forward Modbus requests to slaves connected to the Modbus-RTU network.

FieldLogger must be accessed by the ID “255”. Any other ID will be assumed to be targeting a Modbus-RTU/RS485 slave through **FieldLogger** by the gateway function. On this case, if this functionality is enabled, the data packet will be forwarded to the RS485 bus.



From firmware version 1.40 on, **FieldLogger** also supports the “Modbus RTU over TCP” protocol.

The gateway functionality works as a multiplexer, receiving all the simultaneous Modbus-TCP connections and putting them in a line to be sent to the Modbus-RTU network, one at a time. Due to this line, in a worst-case scenario, Modbus-TCP clients timeout should be set as big or bigger than Modbus-RTU master timeout (configured in the Remote Channels screen) multiplied by the number of the active Modbus-TCP connections. If the client Modbus-TCP timeout is smaller than that value, a timeout must occur instead of an exception code “0Bh” (Gateway Target Device Failed to Respond) in a missing slave situation.

SENDING E-MAILS - SMTP

FieldLogger can be configured to send e-mails to multiple receivers upon the occurrence of alarms or events. The receivers must have been entered in the equipment through configuration. In alarms configuration, we must select which receivers should be notified via e-mail on the occurrence of each alarm or event.

For this service, you must configure an e-mail server that will be accessed at the time of the alarm occurrence. On this server, there obviously must be a valid e-mail account for the **FieldLogger** to login.

Note: SSL connections are not supported.

In the e-mail message bodies there are two parts: a constant part that is common to all messages, and a variable part that is dependent on the alarm or event that originated the message. The constant part is defined by the user, as well as the message subject. The variable part contains the **FieldLogger** tag, its serial number and a string describing the alarm condition or event that caused the message.

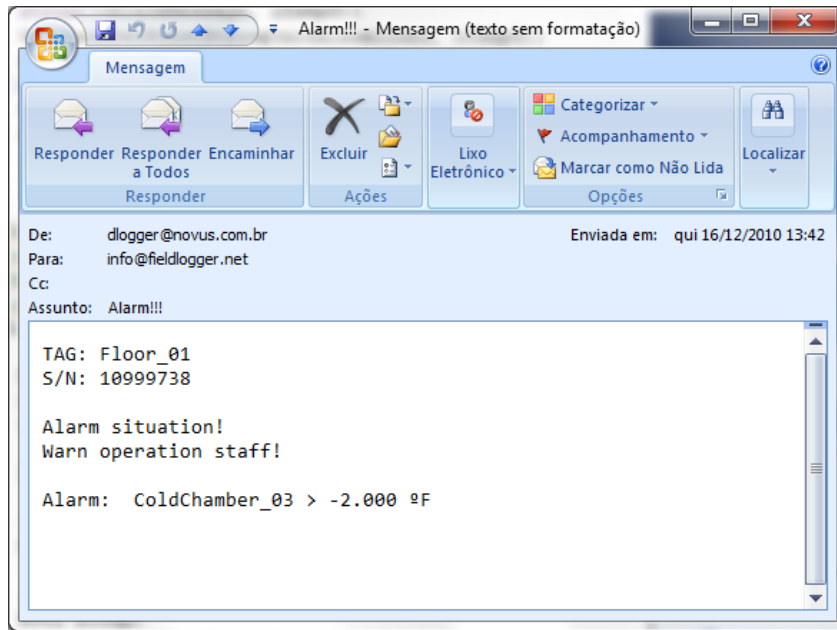


Fig. 22 - Example of alarm message

IMPORTANT: E-mails do not have delivery or reading guarantees. Thus, in alarm cases, try to use some other ways to report alarm or events.

WEB PAGES - HTTP

FieldLogger has the capacity to serve web pages. It has three unchangeable and always available pages with basic information about channels, configuration, status and alarms. Besides that, from firmware version 1.30 on, is is capable of serving custom web pages, which are hosted in the SD card.

UNCHANGABLE PAGES

FieldLogger has the capacity to serve three unchangeable web pages: one that has basic information about the enabled channels, one that has configuration information and equipment status and one with configured alarms information. There are two possible formats for these pages: HTML or XML. These pages include simple HTML code and can be viewed with most popular browsers. They are reloaded automatically at a configurable rate. Pages in XML format have the same information as that found in the related HTML pages, in a standardized format (format descriptions are available in the product CD), which allows the external usage of this data, increasing application flexibility (a typical application is the generation of a customized HTML page with data read from the XML page). There is no automatic reload of XML pages.

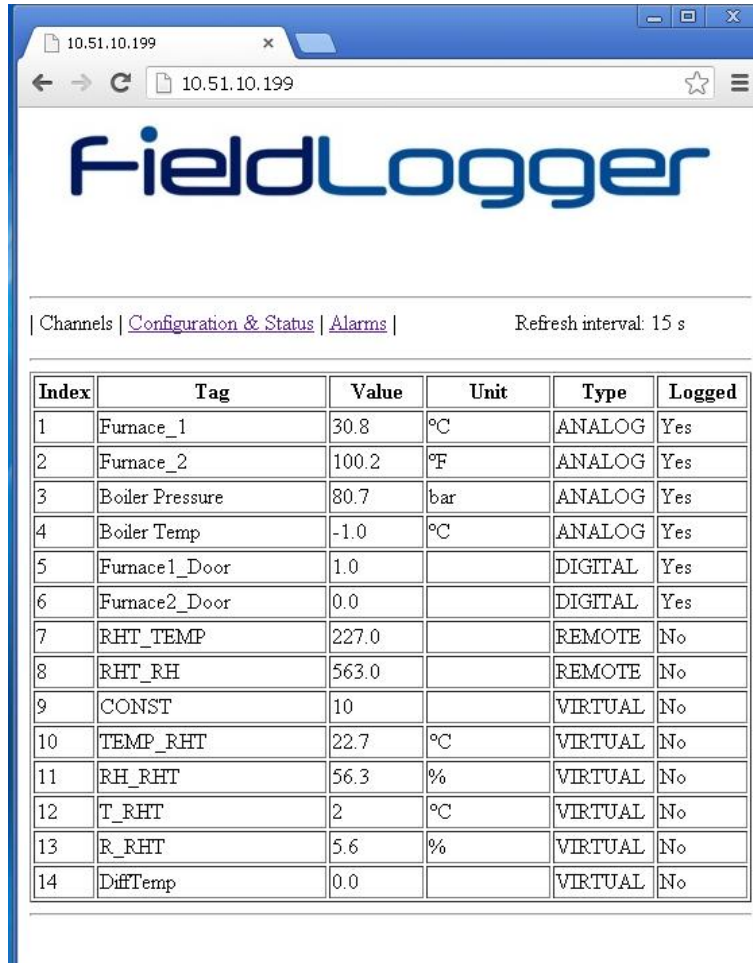
In order to ease information access, it is possible to use links to get directly into the desired webpage and to the most interesting information, as the following table shows.

Web Pages	HTML	XML
Channels	FIELDLOGGER_IP/channels.html	FIELDLOGGER_IP/channels.xml
Configuration and Status	FIELDLOGGER_IP/status.html	FIELDLOGGER_IP/status.xml
Alarms	FIELDLOGGER_IP/alarms.html	FIELDLOGGER_IP/alarms.xml

If only the IP address of the equipment is typed in the browser, the channels HTTP page will be loaded.

	Pages in XML format and the links with direct access to FieldLogger pages are available only from firmware version 1.10 on.
--	--

The channels information page reports, for each enabled channel in the equipment, its tag, its current value, its unit, its type (analog, digital, remote or virtual) and also if this channel is enabled for logging.

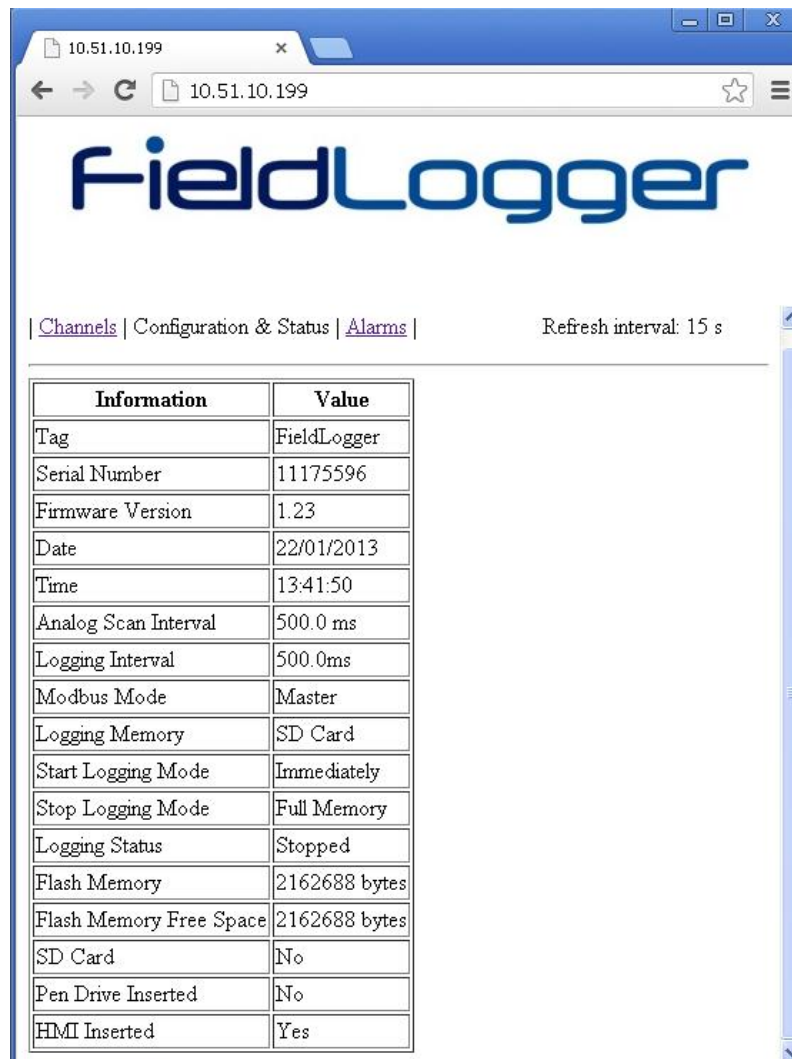


The screenshot shows a web browser window with the URL 10.51.10.199. The page title is "FieldLogger". Below the title, there are navigation links: "Channels", "Configuration & Status", and "Alarms". A "Refresh interval: 15 s" is also displayed. The main content is a table with the following data:

Index	Tag	Value	Unit	Type	Logged
1	Furnace_1	30.8	°C	ANALOG	Yes
2	Furnace_2	100.2	°F	ANALOG	Yes
3	Boiler Pressure	80.7	bar	ANALOG	Yes
4	Boiler Temp	-1.0	°C	ANALOG	Yes
5	Furnace1_Door	1.0		DIGITAL	Yes
6	Furnace2_Door	0.0		DIGITAL	Yes
7	RHT_TEMP	227.0		REMOTE	No
8	RHT_RH	563.0		REMOTE	No
9	CONST	10		VIRTUAL	No
10	TEMP_RHT	22.7	°C	VIRTUAL	No
11	RH_RHT	56.3	%	VIRTUAL	No
12	T_RHT	2	°C	VIRTUAL	No
13	R_RHT	5.6	%	VIRTUAL	No
14	DiffTemp	0.0		VIRTUAL	No

Fig. 23 - Channels information HTML page

The configuration and status information page has the current status of some parameters, as well as serial number, firmware version and other information from the equipment.



10.51.10.199

10.51.10.199

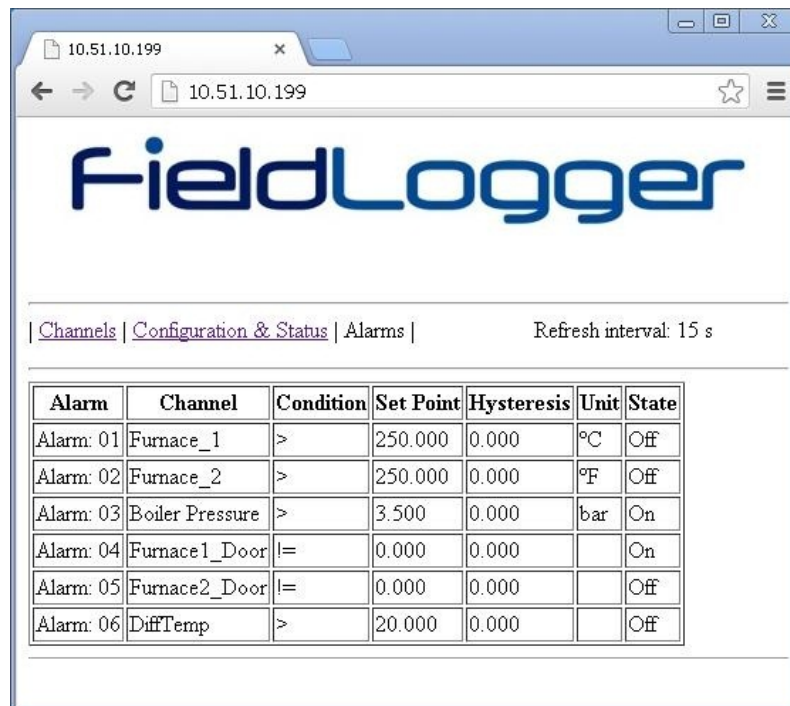
FieldLogger

| [Channels](#) | [Configuration & Status](#) | [Alarms](#) | Refresh interval: 15 s

Information	Value
Tag	FieldLogger
Serial Number	11175596
Firmware Version	1.23
Date	22/01/2013
Time	13:41:50
Analog Scan Interval	500.0 ms
Logging Interval	500.0ms
Modbus Mode	Master
Logging Memory	SD Card
Start Logging Mode	Immediately
Stop Logging Mode	Full Memory
Logging Status	Stopped
Flash Memory	2162688 bytes
Flash Memory Free Space	2162688 bytes
SD Card	No
Pen Drive Inserted	No
HMI Inserted	Yes

Fig. 24 - Configuration and status information HTML page

Alarms information page shows, for each enabled alarm, its index, the related channel, the condition, the set point, hysteresis, the unit (if configured) and if the alarm is activated (ON) or not (OFF).



Alarm	Channel	Condition	Set Point	Hysteresis	Unit	State
Alarm: 01	Furnace_1	>	250.000	0.000	°C	Off
Alarm: 02	Furnace_2	>	250.000	0.000	°F	Off
Alarm: 03	Boiler Pressure	>	3.500	0.000	bar	On
Alarm: 04	Furnace1_Door	!=	0.000	0.000		On
Alarm: 05	Furnace2_Door	!=	0.000	0.000		Off
Alarm: 06	DiffTemp	>	20.000	0.000		Off

Fig. 25 - Alarms information HTML page

CUSTOM PAGES



Pages in XML format and the links with direct access to **FieldLogger** pages are available only from firmware version 1.10 on.

FieldLogger can serve web pages that are hosted in its SD card, since they are located in the “webserv” folder. These pages can use many information directly from **FieldLogger**, like channels values and units, clock time and serial number.

Working conditions

- All needed files must be placed inside the “webserv” folder in the SD card.
- **FieldLogger** works in the “8.3” file name format, so no file should have more than 8 characters (plus the 3 of the extension).
- Files with markers that should be replaced by **FieldLogger** information need their names to start with the “_” character. Otherwise, these markers will not be replaced. Files which are not started with this “_” will not be parsed and will be served faster.
- Subfolders are accepted, though the maximum path length must be limited to 60 characters top (including the “webserv” folder and the “/” characters).
- If a valid marker is used with a channel or alarm that does not exist (example: analog channel 130), an “ERROR” message is returned.
- If a valid marker is used with a channel or alarm that is disabled, a “DISABLED” message is returned.
- Whenever you want to display the character “%”, it is advisable to use it doubled “%%”. It will assure that it will not be misinterpreted with a marker start.

Markers

A lot of information from **FieldLogger** is available to be inserted in the custom web pages. It is done by the use of alphanumeric markers that, when found in the file, are replaced by their related value. Again, this will only happen in the files whose names start with a “_” (example: “_data.htm”).

These are all available markers:

Marker	Replacement information
%ANALOG__001.T%	Analog channel 1 tag
%ANALOG__001.V%	Analog channel 1 current value
%ANALOG__001.U%	Analog channel 1 unit
%ANALOG__001.D%	Analog channel 1 diagnostics information value: Bit 0: open sensor Bit 1: shorted Pt100/Pt1000 Bit 2: out of limits Bit 3: Pt100/Pt1000 open cable
...	...
%ANALOG__008.T%	Analog channel 8 tag
%ANALOG__008.V%	Analog channel 8 current value
%ANALOG__008.U%	Analog channel 8 unit
%ANALOG__008.D%	Analog channel 8 diagnostics information value: Bit 0: open sensor Bit 1: shorted Pt100/Pt1000 Bit 2: out of limits Bit 3: Pt100/Pt1000 open cable
%DIGITAL__001.T%	Digital channel 1 tag
%DIGITAL__001.V%	Digital channel 1 current value
%DIGITAL__001.U%	Digital channel 1 unit
...	...
%DIGITAL__008.T%	Digital channel 8 tag
%DIGITAL__008.V%	Digital channel 8 current value
%DIGITAL__008.U%	Digital channel 8 unit
%REMOTE__001.T%	Remote channel 1 tag
%REMOTE__001.V%	Remote channel 1 current value
%REMOTE__001.U%	Remote channel 1 unit
...	...
%REMOTE__064.T%	Remote channel 64 tag
%REMOTE__064.V%	Remote channel 64 current value
%REMOTE__064.U%	Remote channel 64 unit
%VIRTUAL__001.T%	Virtual channel 1 tag
%VIRTUAL__001.V%	Virtual channel 1 current value
%VIRTUAL__001.U%	Virtual channel 1 unit
...	...
%VIRTUAL__128.T%	Virtual channel 128 tag
%VIRTUAL__128.V%	Virtual channel 128 current value
%VIRTUAL__128.U%	Virtual channel 128 unit
%ALARM__001.STS%	Alarm 1 tag
%ALARM__001.SPT%	Alarm 1 status: “ON” (active alarm) or “OFF” (not active)
%ALARM__001.CND%	Alarm 1 configured setpoint

%ALARM__001.UNI%	Alarm 1 configured condition: ">", ">=", "<", "<=", "==" or "!="
%ALARM__001.HYS%	Alarm 1 configured unit
...	...
%ALARM__032.TAG%	Alarm 32 tag
%ALARM__032.STS%	Alarm 32 status: "ON" (active alarm) or "OFF" (not active)
%ALARM__032.SPT%	Alarm 32 configured setpoint
%ALARM__032.CND%	Alarm 32 configured condition: ">", ">=", "<", "<=", "==" or "!="
%ALARM__032.UNI%	Alarm 32 configured unit
%ALARM__032.HYS%	Alarm 32 configured hysteresis
%INFO.IN.FLTAG_%	FieldLogger tag
%INFO.IN.SERIAL%	Serial Number
%INFO.IN.FWVER_%	Firmware version
%INFO.IN.MBMODE%	Main RS485 interface Modbus mode: "Disabled", "Master" ou "Slave"
%INFO.IN.MBADDR%	Main RS485 interface Modbus address
%INFO.IN.D_TYPE%	Selected logging memory: "Flash" or "SD Card"
%INFO.IN.START_%	Start logging mode selected: "Immediately", "Date/Time", "Alarm" ou "Via Modbus Only"
%INFO.IN.STOP_%	Stop logging mode selected: "Full Memory", "Circular Memory", "Date/Time" ou "Alarm"
%INFO.IN.FDRVIN%	USB flash drive connection status: "Yes" (connected) or "No" (disconnected)
%INFO.IN.SDSIZE%	SD card memory capacity, in kbytes
%INFO.IN.SDFREE%	SD card available free memory, in kbytes
%INFO.IN.INSIZE%	Internal flash memory capacity, in bytes
%INFO.IN.INFREE%	Internal flash available free memory, in bytes
%INFO.IN.ANLSCN%	Analog channels scan interval, in ms
%INFO.IN.LOGPER%	Logging interval, in ms
%INFO.IN.LOGSTS%	Current logging status: "Logging" or "Stopped"
%INFO.IN.HMICON%	HMI connection status: "0" (no HMI) or "1" (HMI connected)
%INFO.RTC.YEAR_%	Internal calendar year
%INFO.RTC.MONTH%	Internal calendar month
%INFO.RTC.DAY_%	Internal calendar day
%INFO.RTC.HOUR_%	Internal clock hour
%INFO.RTC.MIN_%	Internal clock minute
%INFO.RTC.SEC_%	Internal clock second

Examples

There are examples available for download in the product website and also in the product CD.

FILE TRANSFER - FTP

The **FieldLogger** provides both FTP client and server for the transference of logged data files.

Client

FTP client is used to make programmed downloads of logging data. It can be done once a day, in a determined time, or many times a day, in a determined time interval (this option requires firmware version 1.50 or higher). In order to use, simply configure the username and password to be used in server login and set the daily download start time or the interval between them, depending if the "periodic" download (more than once a day) option is enabled. In case of downloading at periodic intervals, start download moments are always referred to midnight (example: 4-hour interval will turn out to downloads at 00:00, 04:00, 08:00, 12:00, 16:00 and 20:00). If, at the time configured for starting the download, a problem with the connection arises, **FieldLogger** will retry for 30 minutes.

From firmware version 1.40 on, there is the possibility to download data directly in the CSV (comma-separated values) format. When selecting this option for the client FTP download, the files created in the download folder will be in the CSV format instead of the binary (standard) format.

The created CSV file will have the equipment tag in its first row. In the second row, there will be the column names. From the third row on, there are the dates, times and channel values for each log. If the logging rate was configured in milliseconds, this extra column will be placed before the values columns. All fields are between quotation marks (") and the field separator used is the semi-colon (;).

Due to the extra processing to transform the files to the CSV format, this option may cause a delay in the download.

Note: Due to a limited size of **FieldLogger** internal buffer, it is recommended that FTP server welcome message should have sentences no longer than 60 characters (each sentence must necessarily be finished with "car return" and "new line" characters, or "0Dh" and "0Ah" in hexadecimal).

Server


To use FTP server on **FieldLogger**, simply enable this feature in the Configurator application and set up a username and password. In this way, the user will have access to the data files for read-only purposes.

The standard used for the FTP is the "Unix" type.

Note: There is no support for simultaneous connections. Therefore, the used client will have to be configured to just use one connection. In addition, the client must be configured to use the passive mode.

NETWORK MANAGEMENT - SNMP

All of the enabled channels for reading, as well as several status information, have their values available via SNMP protocol (read-only, there is no writing implemented on the equipment via SNMP).

	<p>Standard MIBs are not available in FieldLogger. Available SNMP information is listed below, besides the following OIDs of the "System" group:</p> <ul style="list-style-type: none"> • sysDescr • sysObjectID • sysUpTime
---	--

The available MIB is described below. A MIB file is available in the product CD. The branch "Enterprise" of MIB is used, where the "Enterprise number" is **34590**. The sub-branch assigned to **FieldLogger** is **1**. Thus, all information will have the OID starting in **1.3.6.1.4.1.34590.1**.

Here follows the available OIDs:

- 1.3.6.1.4.1.34590.1.0 = Device tag. [OCTET STRING]
- 1.3.6.1.4.1.34590.1.1 = Device serial number. [OCTET STRING]
- 1.3.6.1.4.1.34590.1.2 = Firmware version. [OCTET STRING]
- 1.3.6.1.4.1.34590.1.3 = Device date year. [INTEGER]
- 1.3.6.1.4.1.34590.1.4 = Device date month. [INTEGER]
- 1.3.6.1.4.1.34590.1.5 = Device date day. [INTEGER]
- 1.3.6.1.4.1.34590.1.6 = Device time hour. [INTEGER]
- 1.3.6.1.4.1.34590.1.7 = Device time minute. [INTEGER]
- 1.3.6.1.4.1.34590.1.8 = Device time second. [INTEGER]
- 1.3.6.1.4.1.34590.1.9 = RS485 interface enabling and configuration (0 = disabled; 1 = master; 2 = slave). [INTEGER]
- 1.3.6.1.4.1.34590.1.10 = Selected logging memory (0 = internal memory; 1 = SD card). [INTEGER]
- 1.3.6.1.4.1.34590.1.11 = Logging status (0 = logging stopped; 1 = logging in progress). [INTEGER]
- 1.3.6.1.4.1.34590.1.12 = Available memory for logging in internal memory, in bytes. [INTEGER]
- 1.3.6.1.4.1.34590.1.13 = Presence of SD card (0 = no card; 1 = card present). [INTEGER]
- 1.3.6.1.4.1.34590.1.14 = Available memory for logging in the SD card, in kilobytes. [INTEGER]
- 1.3.6.1.4.1.34590.1.15 = Presence of USB flash drive (0 = no USB flash drive; 1 = USB flash drive present). [INTEGER]
- 1.3.6.1.4.1.34590.1.16 = Presence of HMI (0 = no HMI; 1 = HMI present). [INTEGER]
- 1.3.6.1.4.1.34590.1.17 = Total number of enabled channels. [INTEGER]
- 1.3.6.1.4.1.34590.1.18.X.Y
 - X = Sequential channel number, starting with analog channels and followed by the digital, remote and virtual ones:

- X = 1: First channel enabled.
- X = 2: Second channel enabled.
- etc.
- Y = Channel information:
 - Y = 1: Channel tag. [OCTET STRING]
 - Y = 2: Channel read value. Wherever appropriate (virtual and analog channels, for example), it will be multiplied by the number of decimal places configured by the user. [INTEGER]
 - Y = 3: Channel unit. [OCTET STRING]
 - Y = 4: Channel type indication (analog, digital, etc.), and the channel number related to this type. Examples: ANALOG_001, DIGITAL_005, REMOTE_014, VIRTUAL_103. [OCTET STRING]
 - Y = 5: Channel error indication (0 = channel ok; 1 = channel in error state). [INTEGER]
 - Y = 6: Indicates that the channel is enabled (value = 1) or disabled (value = 0) for logging. [INTEGER]

Traps

Traps will be generated if enabled and if selected in the alarms in order to warn about their occurrence. The address and port of destination are configurable.

They have the following fields:

- Community: "**FieldLogger**".
- OID: .1.3.6.1.4.1.34590.1.100 (where **34590** is the "enterprise number" used and the **1** following is the branch of **FieldLogger**)
- General number: 6 (indicating that the trap is "enterprise-specific").
- Specific number: Index for the occurred alarm (zero - based).
- Trap value
 - OID: .1.3.6.1.4.1.34590.1.100.XX, where XX is the index of the occurred alarm.
 - Type: OCTET STRING.
 - Value: String indicating the occurred alarm in the format: TAG + CONDITION + VALUE. Example: "Channel_1 > 129.43"

CLOUD

From firmware version 1.40 on, **FieldLogger** can connect to a remote server, in order to make its data available through the cloud (Internet).



The use of remote access requires an Internet connectivity service!

NOVUS offers a remote server option. Search the website for the specific service documentation.

If using another connectivity service, see the section "Authorization and Other Details" for the connection details for the configuration and acceptance of **FieldLogger** in the remote server.

OPERATION

Once connected, it waits the receipt of Modbus commands using the remote server. Upon receiving these commands, it checks the need to forward them to possible slaves of the RS485/Modbus RTU network that are connected to it and sends the received answer from the slave back to the server.

AirGate-GPRS constantly monitors the state of the connection. Once it perceives a disconnect with the cellular network or with the remote server, it immediately attempts to reconnect, in order to always keep the path open for new remote requests and to the sending of SMS messages of alarm or status notification.

AUTHENTICATION AND OTHER DETAILS

FieldLogger will connect with the IP and the configured gates. If, instead of an IP, a URL was configured to access the remote server, this name will be resolved by the equipment and the connection will be made the same way.

Three levels of authentication may be selected: without authentication, simple authentication, and NAP.

No Authentication

After the connection, no package is transmitted by the **FieldLogger** except the user application data.

Open Authentication

After the connection, in a time frame of up to 5 seconds, the **FieldLogger** will send an authentication package with the following format:

String "NOVUS-".	Serial number of (8 AirGate-GPRS digits) in ASCII.	Code "-0500-" in ASCII.	Firmware version for FieldLogger (4 characters) Example: "1.40".
------------------	---	-------------------------	--

As an example, a **FieldLogger** with a serial number 12546890 and firmware version 1.40 would have an authentication package equal to "NOVUS-12546890-0105-1.40".

FieldLogger awaits an "OK" response (ASCII) from the server. If this answer does not arrive in one second, the authentication package will be resent.

NAP

NAP is a proprietary authentication protocol of NOVUS. Since it is reinforced by cryptography and with other security features, it is the level of authentication suggested to be used with NOVUS remote server.

DATA LOGGING AND DOWNLOAD

Data logging can be done in the internal memory of **FieldLogger** or, optionally in a SD card (not included), which must be inserted into the proper compartment behind the cover (or HMI), as shown in **Fig. 21**. The internal memory capacity is up to 532,480 loggings, while SD card logging capability will depend on its storage capacity (size), assuming that the card is empty.

Note: Poor quality of the card can compromise data logging, causing missed logging periods at higher logging rates or being more susceptible to data write corruption. Therefore, it is always recommended the usage of high-speed (class 4 or higher) SD cards of established brands.



SD Card logging not available in models "**FieldLogger – USB, 512k logs, RS485**" and "**FieldLogger – USB, 512k logs, RS485, 24 V**".

Any kind of channels (analog, digital, remote and virtual ones) can be written into the memory. Logging is periodic and has its period (rate) set through the Configurator software. After each time interval, the current values of the configured channels are logged in the selected memory.

There are several ways to start and stop the loggings, and many of them can be freely combined. During the logging, all the selected channels will be recorded in the requested memory (internal flash or SD card) based on the interval between loggings configured.

Depending on the start and stop modes selected, there may be "snippets" of logs in memory, and therefore, periods without any data recorded. This is fully compatible with the equipment and means no problem at all.

The start modes available are the following:

- Immediate start: Loggings will be started right after the equipment reconfiguration.
- By date/time: Loggings will be started on the configured date/time.
- By alarm: When the alarm condition is met (alarm active), loggings will be started.
- Only by Modbus commands: Loggings will be started only when a specific command is sent to the Modbus equipment.

The stop modes available are the following:

- Full memory: The loggings will be stopped only when the selected memory (internal flash or SD card) has no more available space.
- Never stop (circular memory): Loggings will be continually done in the selected memory. When filling up the memory, the oldest data are erased so that the most recent data may be saved.
- By date/time: Loggings will be started on the configured date/time.
- By alarm: If loggings were started by the same alarm, when the alarm condition is no longer met (alarm inactive), loggings are stopped. If loggings were started for some other reason, as soon as the alarm condition takes place (alarm active), loggings will be stopped.
- By Modbus command: A specific Modbus command can be sent to stop loggings. This command is independent of the selected stop mode and has priority over it.

The following possibilities to start and stop loggings are available:

		Logging start			
		Immediate	Date/Time	Alarm	Only Modbus command
Logging stop	Full memory	Yes	Yes	Yes	Yes
	Circular memory	Yes	Yes	No	Yes
	Date/Time	Yes	Yes	No	No
	Alarm	Yes	Yes	Yes	No

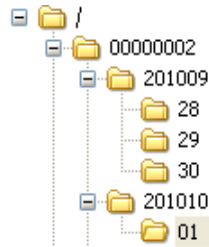
Here are operation details for each of these modes:

- Immediate start and stop when memory gets full: As soon as the new configuration is applied, loggings are started. The **FieldLogger** follows on logging until filling up the memory (internal or SD card). In the case of a power failure, logging is interrupted, returning as soon as power returns.
- Immediate start and never stops (circular memory): As soon as the new configuration is applied, loggings are started. The **FieldLogger** goes on logging forever, overwriting the oldest data as soon as the memory has no more room for new logs. In the case of a power failure, logging is interrupted, returning as soon as power returns.
- Immediate start and stop by date/time: As soon as the new configuration is applied, loggings are started. The **FieldLogger** goes on logging until the arriving of the date and time set. In the case of a power failure, logging is interrupted, returning as soon as power returns. If the memory fills up before the date/time set, **FieldLogger** will stop logging.
- Immediate start and stop by alarm: As soon as the new configuration is applied, loggings are started. The **FieldLogger** goes on logging until an alarm condition takes place (configured alarm for loggings stop). When leaving alarm condition, loggings return to be done. In the case of a power failure, logging is interrupted, returning as soon as power returns. When memory fills up, **FieldLogger** will stop logging.
- Start by date/time and stop when memory gets full: Once the date/time set for loggings start has arrived, loggings will start. **FieldLogger** goes on logging until filling up the memory (internal or SD card). In the case of a power failure, logging is interrupted, returning as soon as power returns.
- Start by date/time and never stops (circular memory): Once the date/time set for loggings start has arrived, loggings will start. **FieldLogger** goes on logging forever, overwriting oldest data as soon as the memory has no more room for new logs. In the case of a power failure, logging is interrupted, returning as soon as power returns.
- Start by date/time and stop by date/time: Once the date/time set for loggings start has arrived, loggings will start. **FieldLogger** goes on logging until the arriving of the date and time set. In the case of a power failure, logging is interrupted, returning as soon as power returns (in case the stop date/time has not yet elapsed). If the memory fills up before the set up date / time, **FieldLogger** will stop logging.
- Start by date/time and stop by alarm: Once that the date/time set for the loggings start has arrived, loggings will start. **FieldLogger** goes on logging until an alarm condition takes place (configured alarm for loggings stop). When leaving alarm condition, loggings return to be done. In the case of a power failure, logging is interrupted, returning as soon as power returns. When memory fills up, **FieldLogger** will stop registering.
- Start by alarm and stop when memory gets full: When an alarm condition takes place (configured alarm for logging start), logging is started (it will not start if, upon applying the configuration, the alarm condition is already satisfied: it must exit the alarm condition and get into it again.) **FieldLogger** goes on logging until filling up the memory (internal or SD card). In the case of a power failure, logging is interrupted, returning as soon as power returns.
- Start by alarm and stop by alarm: When an alarm condition takes place (configured alarm for logging start), logging is started (it will not start if, upon applying the configuration, the alarm condition is already satisfied: it must exit the alarm condition and get into it again). **FieldLogger** goes on logging while this alarm condition is met. When leaving the stop alarm condition, logging is stopped. In the case of a power failure, logging is interrupted, returning as soon as power returns. When memory fills up, **FieldLogger** will stop logging.
- Start only by Modbus command and stop when memory gets full: When the Modbus command for the logging start is sent to the device (more details about this command in the document "FieldLogger – Modbus" and in the chapter "Configuration and Download Software", "Diagnostics" section), logging will start. **FieldLogger** goes on logging until filling up the memory (internal or SD card). In the case of a power failure, logging is interrupted, returning as soon as power returns.
- Start only by Modbus command and never stops (circular memory): When the Modbus command for the logging start is sent to the device (more details about this command in the document "FieldLogger – Modbus" and in the chapter "Configuration and Download Software", "Diagnostics" section), logging will start. **FieldLogger** goes on logging forever, overwriting the oldest data as soon as the memory has no more room for new logs. In the case of a power failure, logging is interrupted, returning as soon as power returns.



Modbus commands to start and stop loggings, when enabled, can be sent at any time and have precedence over the configured start and stop modes. In such a way, if a Modbus command to start loggings is sent to the equipment, they will start up, no matter the state of the equipment in relation to the configured modes (the only exception is a configured mode different from "circular memory" with the memory already full). Similarly, when sending a Modbus command to stop loggings, they will stop regardless of the mode configured for start and stop. If a stop command has been sent and then there is a start situation (as per the configured mode), loggings will not occur, because the command has higher priority than the modes. It is worth to point that the sent command persists even after a power outage. When sending a new logging configuration, however, the previously sent commands are "forgotten".

When logging is done in the SD card, it is generated a folder structure whose purpose is to organize the logging data and to ease access for the data download software to such data. The following figure shows an example of this structure:



In the root folder it is created a folder whose name is the serial number of the equipment. Inside this folder, in its turn, are generated other folders whose name are the year and month in which the logging began. And inside of the year-months folders, other folders are generated whose names are the days in which the loggings start up. The data files are stored within these last folders and their names are made up by the information related to hour, minute, second and hundredths of second of the first log in the file, followed by the extension ".fl". For example, the file /00000002/201010/01/18243516.fl was generated by **FieldLogger** with the serial number 00000002 on October 01, 2010, and the first log contained in this file was held on this day at 18 hours, 24 minutes, 35 seconds and 16 hundredths.

The files generated by the registration process are composed of a header followed by periodic data blocks and *timestamps* (time markers). The header carries information relevant to the logs from that file, essential for the correct interpretation of its data. In the data block are stored values for each channel that is being logged, in floating point format (IEEE 754) with simple precision, where each log occupies 4 bytes. The timestamps are used as time reference to identify the moment in which the channels were logged. Periodic timestamps serve to ensure the integrity of the loggings in time, even under power failure or fault in the SD card.

When the logging is done in internal memory, the file format is exactly the same as when it is written on the SD card. However, by the size of the available memory, all data will be contained in one sole file.

In its internal flash memory, **FieldLogger** has something about 2M bytes that turns into an approximated value of 512k (512000) loggings. The exact loggings number depends a lot on the enabled channels number for loggings and on the configured logging interval. Logging intervals equal or bigger than 30 seconds record, on each logging instant, extra data to indicate the time when the log happened (timestamp), and that increases memory consumption makes the total logging capacity decrease. Therefore, speaking of logging memory usage, the worst possible scenario is logging only one channel on slow (bigger than 30 s) intervals.

Data download consists of copying the data from the internal memory of **FieldLogger** or from the card to a computer. This process, when using the configuration software, is guided and assisted. When done via USB flash drive, it is also simple and automatic. However, when performed manually, via an FTP client, for example, one should take care that the directory structure is kept, otherwise an error may come to occur in the interpretation of the data download.

It is not possible to download data through different interfaces at the same time. If a user starts a download through the Ethernet interface (FTP, for example) and another user tries to download via USB flash drive, this one will not be able to accomplish the download and must wait until the first download has been terminated.

Depending on the amount of data on this equipment, mainly when using high-capacity SD cards, the download process can take hours. In these cases, prepare to make the download through faster interfaces and, perhaps, in more likely times of the day.

The simultaneous data download while in logging process is based on the assumption that the download rate is faster than the logging rate. This is particularly important when using circular memory, because, otherwise, we could never download all the data (the logging, being faster, might eventually turn around, reaching and surpassing the download, which would lead to data inconsistencies). Such being the case, whenever the circular memory is used with high registration rates, you should try to use a faster interface for download.

ALARMS

32 alarms are available in each FieldLogger. Each alarm requires you to choose a channel, a condition, a set point and hysteresis. When the alarm condition is met (example: Channel_1 > 45.0 ° C), an event is generated for which different actions can be associated. For each selected channel, its current value is used in the comparison. In case of digital channels, we will use the values associated with two logical states. When one channel is in error, the configured error value will be used in the alarm. The value of the channel to be used will always be the floating point value.

The available conditions are:

- Greater than (>): Alarm condition is met when the selected channel is greater than the set point.
- Greater than or equal (>=): Alarm condition is met when the selected channel is greater or equal to the set point.
- Minor (<): Alarm condition is met when the selected channel is minor than the set point.
- Minor than or equal (<=): Alarm condition is met when the selected channel is minor or equal to the set point.
- Equal (==): Alarm condition is met when the selected channel is equal to the set point. With this condition, hysteresis does not make much sense and should be maintained at "0.0". Analog channels can hardly have a value exactly equal to the set point value, so you should avoid this condition with analog channels, because it will be an alarm condition that might never be satisfied.
- Different (!=): Alarm condition is met when the selected channel is different from the set point. With this condition, hysteresis does not make much sense and should be maintained at "0.0". Analog channels can hardly have a value exactly equal to the set point value, so you should avoid this condition with analog channels, because it will be an alarm condition that might always be satisfied.

Available actions are:

- Activating the relays (they must have been configured to "activation by alarm" in the Configuration software).
- Activating the digital outputs (they must have been configured to "activation by alarm" in the Configuration software).
- Loggings start: when reaching the alarm condition, starts loggings if they are not already logging.
- Loggings stops: when reaching the alarm condition, stops loggings if they are not already stopped.
- Loggings start and stop: logs while the alarm condition is met.
- Sending e-mails: allows sending an e-mail reporting the alarm condition to up to 10 receivers (they must have been enclosed in the receivers list of the equipment).
- Sending SNMP traps: sends a trap to the configured server with a number regarding the index of the alarm.

Sending e-mails depends on the availability of TCP connections on the part of the **FieldLogger** (it has a limit of simultaneous connections, see the chapter Specifications). Sending traps depends on the availability of UDP connections on the part of the **FieldLogger** (it has a limit of simultaneous connections, see the chapter Specifications).

Just one alarm can start loggings, and just one alarm can stop them. In case you configure the start and/or stop of the logging for alarms, there is no option of "circular memory", that is, loggings will terminate as soon as the loggings available memory gets full.

The alarm condition must stay at least 250 ms in order to ensure that it is detected. In the same way, the output of the alarm condition must remain the least 250 ms in order to guarantee that it is detected. Besides, you should remember that the analog channels can have a delay in the measurement of the true input value, depending on the sensor type, on the interval between readings and the configured filter, among others. The remote channels, in turn, depend directly on the set scan interval. Thus, these types of channels in particular can offer an additional latency in the detection of the alarm condition.

When powering **FieldLogger** up, there are no reliable values in the channels. In case of the analog and remote channels, you should wait for the first scan to be done for valid values to be available. So, alarms that use these kinds of channels may take a while until they are ready to compare with the configured set point. Particularly when using remote channels, a complete scan may take several seconds.

DATA COMMUNICATION

FieldLogger has several communication interfaces. Among them, we may highlight some that can be used as Modbus slaves:

- RS485, acting as a slave on the Modbus RTU protocol.
- USB device, acting as a slave on the Modbus RTU protocol.
- Ethernet, acting as a server in the Modbus TCP protocol.

All the configuration of the equipment, as well as the reading of the data of the inputs, are done via Modbus protocol.

In the document "**FieldLogger** - Modbus.pdf" (in the product CD) is found all the information needed to read data from the input channels without using the Configuration software. To ensure proper configuration and data download of **FieldLogger**, always use the Configuration software. After configuring the equipment, data of its inputs and/or outputs can be accessed by any other software capable of Modbus RTU or Modbus TCP communication.

HMI (HUMAN-MACHINE INTERFACE)

The **HMI** (Human-Machine Interface) is available as an accessory to the **FieldLogger**. Several features are implemented in this device, such as enabled channels monitoring, viewing these channels in chart mode, alarms monitoring, status checking and configuration of some basic **FieldLogger** operation parameters.

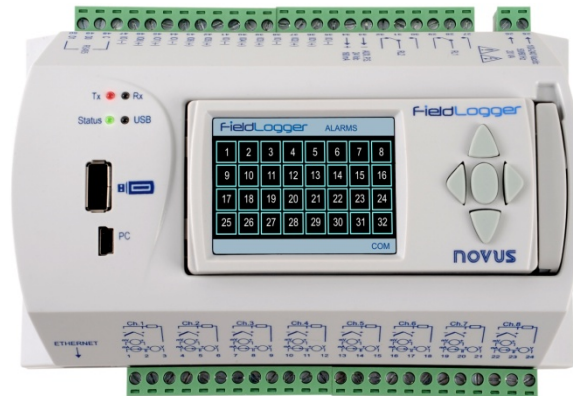


Figure 26 – FieldLogger with HMI

The **HMI** is attached to the **FieldLogger** through a DB9 connector located under its cover. Check the *Attaching and Detaching the HMI* section to see how the **IHM** is connected to the **FieldLogger**.

Both power and serial communication go through the DB9 connector, so it is the only necessary connection. There is also the possibility of using the **IHM** remotely, attached to the **FieldLogger** through an extension cable. As the communication between **IHM** and **FieldLogger** is done through RS485 using a baud rate of 115200 bps what puts a limit to the HMI operation distance is the power, what means that the voltage drop in the power cables (both positive and negative cables summed) must be 0.4 V top. Considering a current consumption of 80 mA, it makes the maximum cable resistance to be 5 ohms. As cable resistance per meter depends mainly on its section, we recommend checking a wire resistance table. For some common cables, HMI's maximum operation distance is shown in **Table 02**.

Gauge	Section	Maximum Length
24 AWG	0.21 mm ²	29 m
22 AWG	0.33 mm ²	47 m
20 AWG	0.52 mm ²	75 m

Table 02 – Wire resistance

Figure 27 below shows the pin-out needed to build an extension cable to the **HMI**.



Figure 27 – Building an extension cable

PIN	SIGNAL	DESCRIPTION
1	-	-
2	+5 V	HMI power input: +5 Vdc
3	-	-
4	B / D1 / D+ / D	RS485 Tx/Rx positive data
5	-	-
6	-	-
7	GND	HMI power input: ground
8	A / D0 / D- / D\	RS485 Tx/Rx negative data
9	-	-

Table 03 – Pin-out for building the DB9 connectors

HMI screen is divided into three sections: top bar, main area and bottom bar. Top bar (**A**) shows the **FieldLogger** logo and the name of the current screen. Main area (**B**) shows the information regarded to that screen. Bottom bar (**C**) shows alarms; download progress and serial communication indication whenever necessary, as shown in the following image.

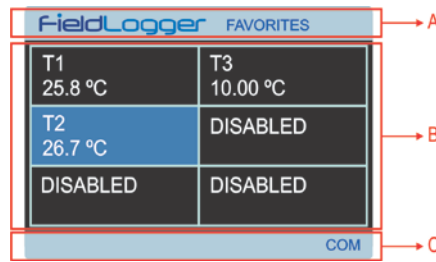


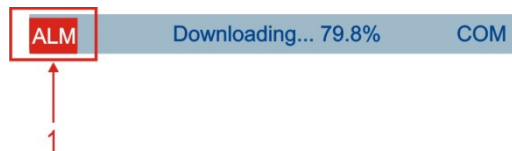
Figure 28 – Screen sections

Bottom bar has the following information, as shown in the picture below:

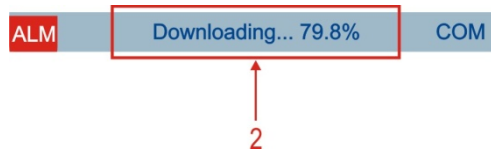


Figure 29 – HMI bottom bar

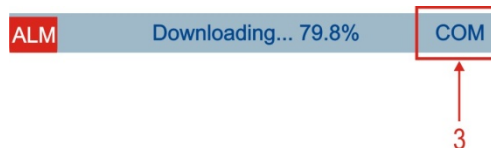
- Alarm events (1): Flags that one or more alarms are active. In order to check which alarms are active, please go to the Alarms screen.



- Download progress (2): When plugging a USB flash drive to download **FieldLogger** data, there is a percentage indication of the download already done. If downloading data from **FieldLogger** internal flash memory, it shows the percentage of the whole memory already downloaded. If downloading from the SD card, it shows the percentage of the current file being downloaded.



- Communication in progress (3): Informs that there is communication going on between the **HMI** and the **FieldLogger**. Typically, this flag must be on most of the time, varying from screen to screen. If this flag stays off and the **HMI** stops updating information, there probably is a communication problem between the **HMI** and the **FieldLogger**.



Interfacing with this **HMI** is done through some buttons, which allow you to navigate between all the available screens, select and edit parameters. The following picture shows the keys and their functions.

Not all characters can be visualized on the HMI. Occidental characters for tags and units are recommended.

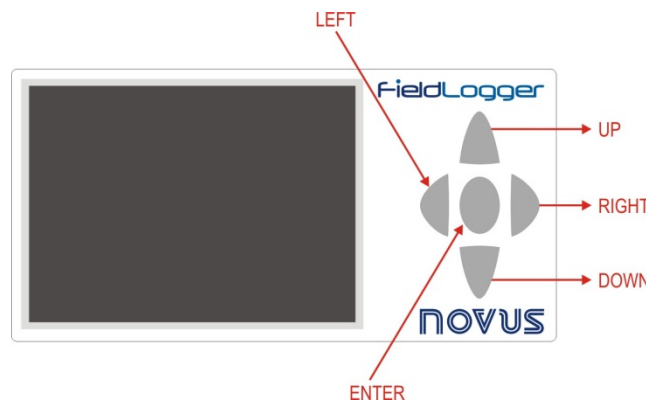
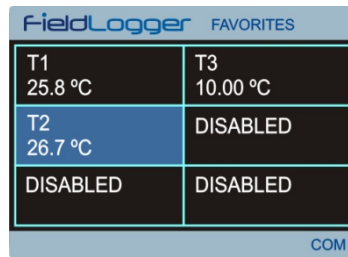


Figure 30 – Functions of the **HMI** keys

Navigation between the screens is accomplished through keys RIGHT and LEFT. There are six different screens, each one with a specific functionality, as follows:

“FAVORITES” SCREEN

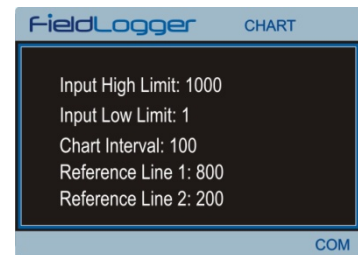
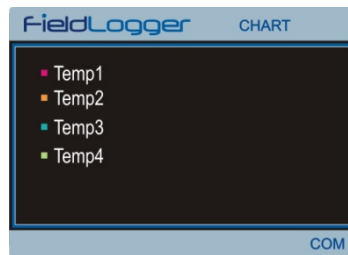
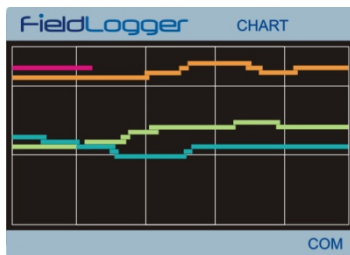
This screen shows a six-position grid where you can assign a channel to be displayed on each position. Every enabled channel in the **FieldLogger** is available for assignment, that is done using UP and DOWN keys to select the desired position in the grid and ENTER to open a list of the available channels. After that, just use the UP and DOWN keys again to find the channel you want to display and ENTER to select it.



“CHART” SCREEN

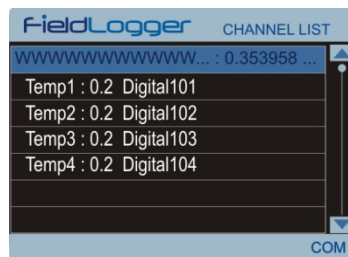
This screen saves a log of the favorite channels values. The time period of this log, the limits of the channels displayed (vertical limits of the chart) and some other parameters can be configured in the “Parameters” screen. Pressing the ENTER key will bring a legend screen with the tags of the favorite channels that is on the chart and their associated colors. Pressing the ENTER key again will show the parameters configured for the chart. Pressing the ENTER key one more time will lead you back to the Chart screen. The red color is reserved to inform that one or more channels have values over the configured high limit or under the configured low limit for the chart.

The log starts at the moment the **HMI** is powered and it is updated constantly, no matter which **HMI** screen is being watched. It is important to notice that this log is limited to the data that can be seen in the screen (100 points) and it is not possible to retrieve old (out-of-the-screen) data. It is also important to notice that this log has nothing to do with the one done by the **FieldLogger**.



“CHANNEL LIST” SCREEN

This screen shows a list with all **FieldLogger** enabled channels (analog, digital, remote and virtual). UP and DOWN keys are used to navigate between the channels. The ENTER key has no function on this screen.



“ALARMS” SCREEN

The Alarms screen is 32-position grid where each numerated position is related to its equivalent alarm or event. Whenever an alarm is active, its number will be displayed in red on this screen.

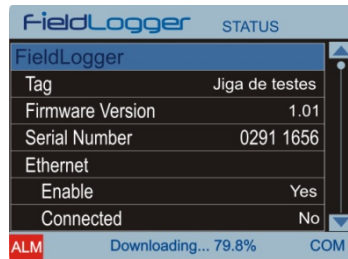
In the left side of the bottom bar an alarm flag will be on as long as any of the **FieldLogger** enabled alarms are active. This flag can be seen in all screens. Keys UP, DOWN and ENTER have no function on this screen.



“STATUS” SCREEN

On this screen, a list is shown with information about **FieldLogger** and the **HMI** itself. Navigation is accomplished by the UP and DOWN keys and there is no function for the ENTER key.

Information is organized in a hierarchical way, where hierarchical levels are displayed by indentation on the left side. Parameters that are more on the right “belong” to the previous parameter (more on the left). For example, information about the Ethernet interface is placed in the “Ethernet” level, and that, by its turn, is placed in the “**FieldLogger**” level.



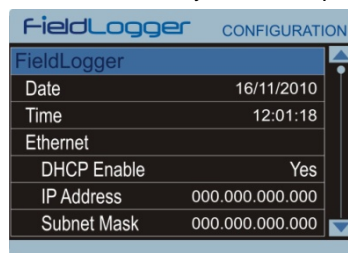
The following parameters can be monitored on this screen:

FieldLogger:	FieldLogger information
Tag.....	Configured tag for the FieldLogger
Firmware Version.....	FieldLogger firmware version
Serial Number.....	FieldLogger serial number
Ethernet.....	Ethernet interface information
Enabled.....	Yes/No if interface enabled/disabled
Connected.....	Yes/No if interface cable connected/disconnected
Data Logger:.....	Information about data logging
Scan Interval.....	Analog scan interval configured
Logging Rate.....	Logging rate configured
Logging Enable.....	Yes/No if logging is enabled/disabled
Storage Memory.....	Shows which memory is being used for data logging
SD Card Connected.....	Yes/No if SD card connected/disconnected
Logging Status.....	Indicates if logging is running or if it is stopped
Logging Mode.....	Logging mode information
Start.....	Indicates how logging is supposed to start
Stop.....	Indicates how logging is supposed to stop
SD Free Memory.....	Shows the available memory for logging in the SD card
Int. Free Memory.....	Shows the available memory for logging in the internal memory
HMI	HMI information
Firmware Version.....	HMI firmware version
Serial Number.....	HMI serial number

“CONFIGURATION” SCREEN

Some **FieldLogger** and **HMI** parameters can be changed on this screen. In order to edit a parameter, you should first select it by pressing the UP and DOWN keys. Once it is selected, press the ENTER key to put it into edit mode. When in edit mode, the UP and DOWN keys can be used to edit the parameter value (increment and decrement). When editing a parameter composed by more than one field (like IP addresses) you should select the correct field using the RIGHT and LEFT keys. Single field parameters that have a wide range have a customized edition way, where you can change the increment/decrement factor using the RIGHT and LEFT keys during edition: it starts with a factor of “1”; every time you press the LEFT key, it multiplies this factor for 10 (tens, hundreds, thousands, ...); every time you press the RIGHT key, it divides this factor for 10 (thousands, hundreds, tens, ...). Once you have the desired value, just press ENTER to get it out of the edit mode.

Just like the “Status” screen, information is organized in a hierarchical way. As an example, information about the Ethernet interface is placed in the “Ethernet” level, and that, by its turn, is placed in the “**FieldLogger**” level.



The available parameters of this screen are:

FieldLogger	FieldLogger configuration
Date	Date configuration
Time	Time configuration
Ethernet	Ethernet interface configuration
DHCP Enable.....	DHCP enabling
IP Address	IP address configuration
Subnet Mask	Subnet mask configuration
Gateway	Gateway address configuration
Modbus RTU.....	Modbus RTU interface configuration
Mode	Operation mode: master/slave
Slave Address.....	Modbus slave address
Baud rate	Communication baud rate
Parity.....	Communication parity
HMI	HMI configuration
Backlight Timeout.....	Time to turn the backlight off (0 = always on)
Chart	“Chart” screen configuration
Color Background	Background color: black/white
Interval	Period of time displayed on the Chart
Reference Value 1	First reference line value*
Reference Value 2	Second reference line value*
Input High Limit	Chart maximum displayed value**
Input Low Limit.....	Chart minimum displayed value**

* For disabling the reference lines, just configure them to a value out of the input configured range.

** If the Low Limit is configured to a value greater than the High Limit, the Chart will not display the values of the channels in a correct way!

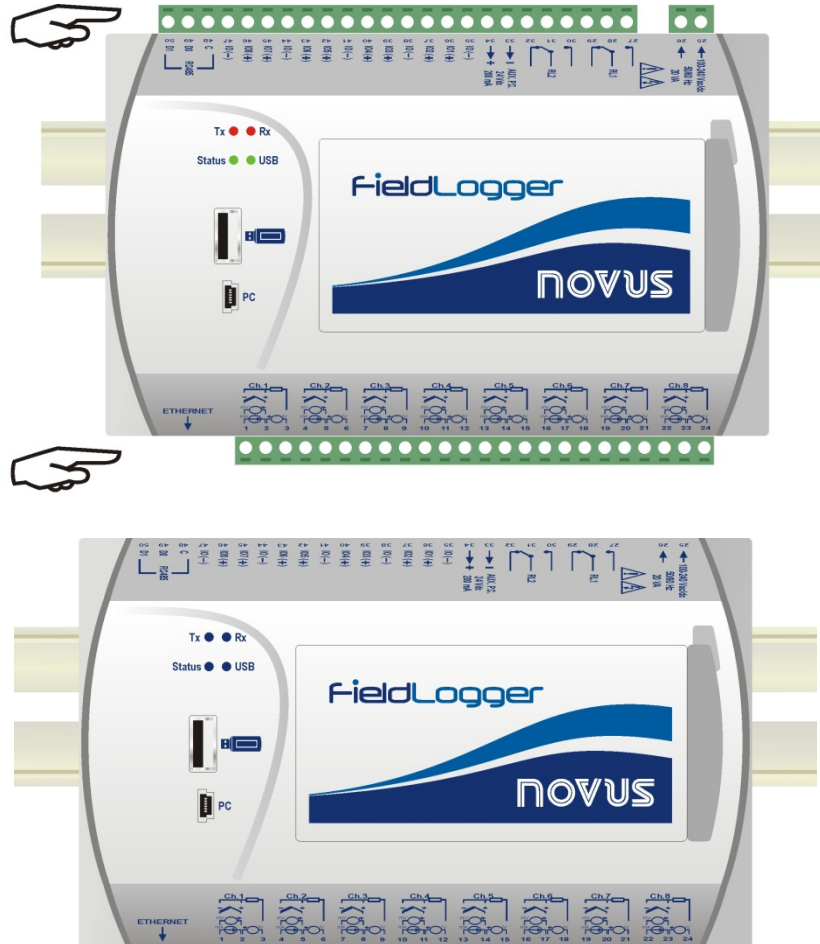
EQUIPMENT SOFTWARE (FIRMWARE) UPDATE

The **FieldLogger** allows the update of its embedded software (firmware) in the field, through a USB flash drive. The versions of this software for this equipment are available on the equipment web site. Following is the procedure for updating the software.

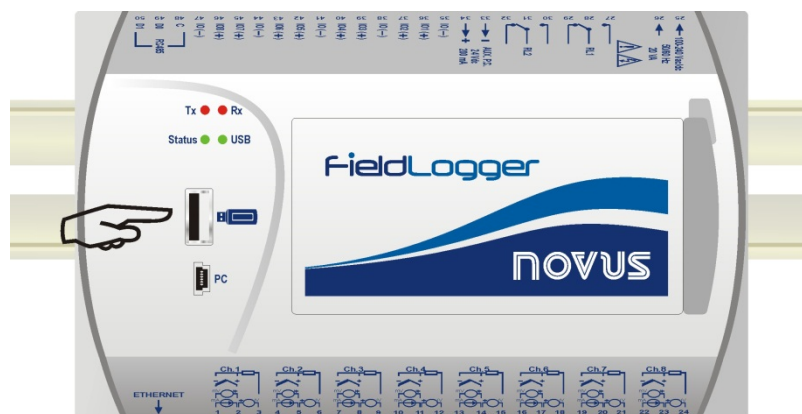


Before performing the update, proceed with the data download and, if desired, also the reading of the equipment's configuration and saving it to a file. Both the configuration and the logged data in flash will be lost in the upgrade process.

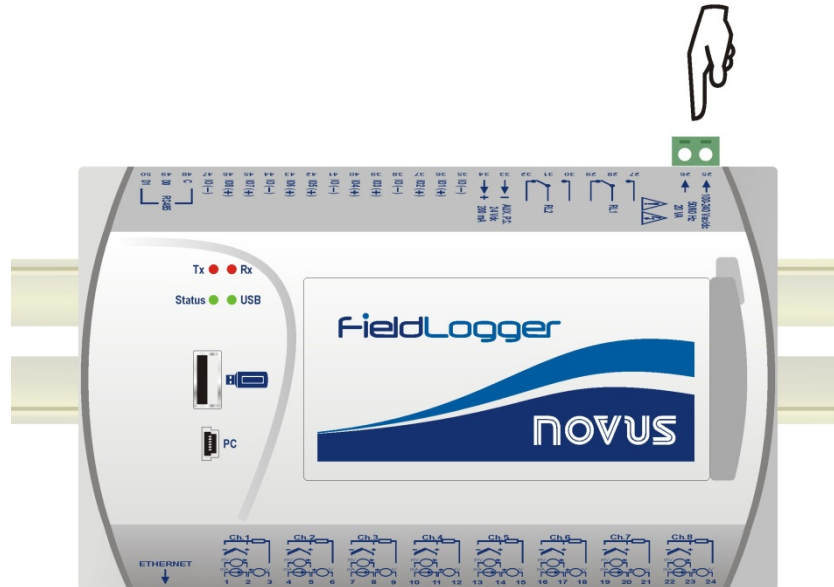
1. Turn off and unplug all **FieldLogger** connectors attached to it.



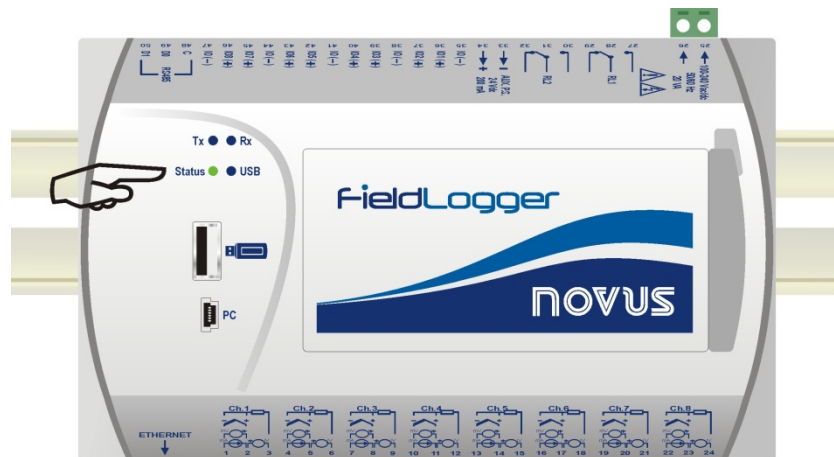
2. Copy the *flogger.flb* file, which is the binary firmware file of the **FieldLogger**, into USB flash drive root folder.
3. Insert the USB flash drive into the USB host of the **FieldLogger** (that must remain off).



- Replace the plug and powering cord of the equipment, then turn **FieldLogger** ON again. The status and USB LEDs should flash together, indicating that the boot loader is running.



- The status led should still be flashing in the same pattern. The USB led should flash quickly while the *flogger.flb* file copy is being performed. Once the copy has been done, the USB led should stay lit, indicating that the USB flash drive can be removed.



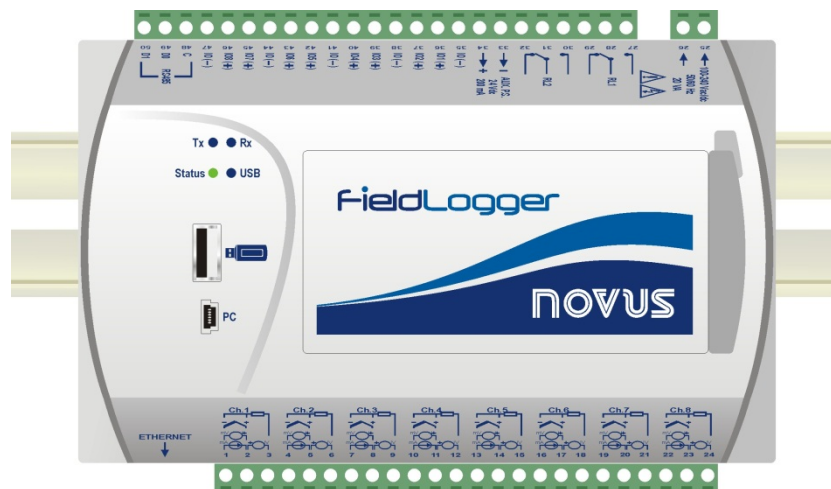
- If during the copy (writing) of the firmware of **FieldLogger** there is some kind of error, this will be indicated by the status led that is to stop flashing periodically and repeatedly showing a pattern of blinking as per the occurred error.

Blinks	Meaning
1	An error occurred in reading <i>flogger.flb</i> file.
2	Error in initializing the FieldLogger USB host (when inserting the USB flash drive)
3	Error in erasing the FieldLogger program memory.
4	Error in writing the FieldLogger program memory.
5	The written firmware is bigger than the program memory available in the FieldLogger . The writing was partial.
6	Error in closing <i>flogger.flb</i> file.
7	Invalid <i>flogger.flb</i> file.

7. Remove the USB flash drive from the USB host of the **FieldLogger**.


FieldLogger should reset itself automatically and may be used normally, now with the new updated firmware.

We recommend deleting from the USB flash drive the firmware file (*flogger.flb*) so that no undesired updates in the future occur.



CLOCK BATTERY REPLACEMENT

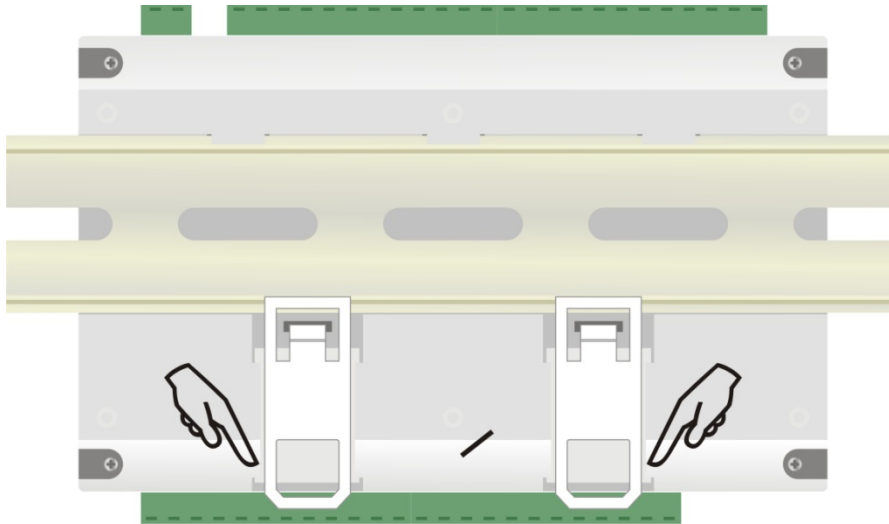
FieldLogger clock is kept by an internal battery as long as the equipment is not powered by the AC mains power. In case of discharge of this battery, logged dates and times may not represent real values. **FieldLogger**, whenever detecting such a situation, informs it by continuously flashing the Status led three times in a row (check the *Flags (LEDs)* section).



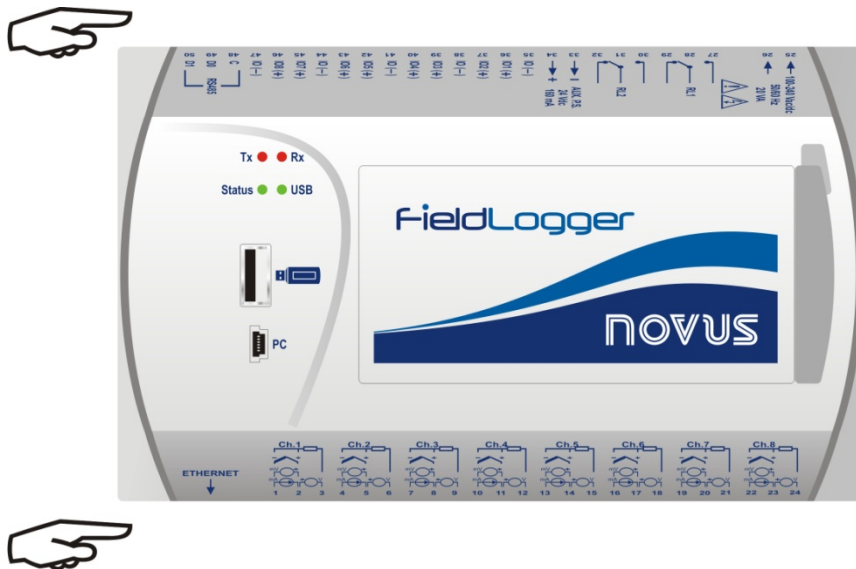
Replace battery with Panasonic lithium battery Part No. CR 2032 only.
Usage of another battery may present a risk of fire or explosion.

Replacement procedure is described as follows:

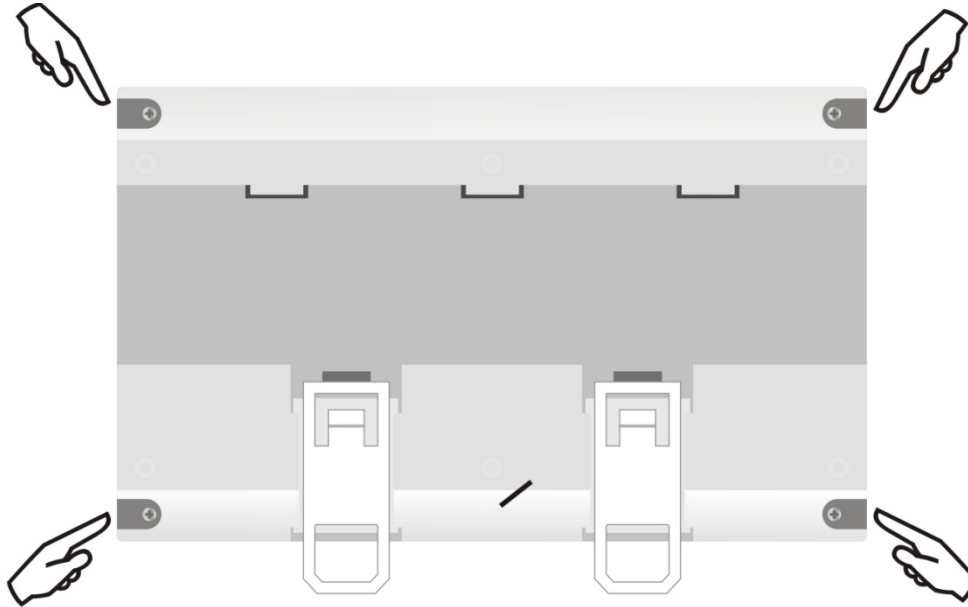
- Detach **FieldLogger** from DIN rail.



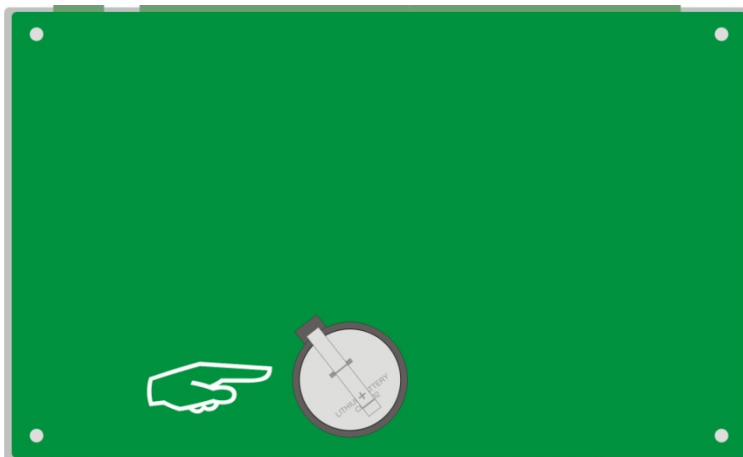
- Disconnect all terminals carefully.



- Unscrew the four screws located under the enclosure. Remove the back cover, taking care not to remove the circuit board.



- After removing the back cover, remove the battery. Avoid touching the circuit board!



- Insert the new battery and put back the back cover and its four screws.



SPECIFICATIONS

Power:

- 100 to 240 Vac \pm 10 %, 50/60 Hz. Maximum consumption: 20 VA.
- **24 V Model:** 24 Vac/dc \pm 10%, 50/60 Hz. Maximum consumption: 10 VA.

Environmental Conditions: Operating temperature: 0 to 50 °C. Relative Humidity: 80 % to 30 °C. For temperatures above 30 °C, decrease 3 % per °C.

For internal use.

Installation category II.

Pollution degree II.

Altitude < 2000 m.

Dimensions: 164 x 117 x 70 mm

Weight: 400 g

Housing: ABS+PC

Protection: IP20

Analog Inputs:

The types of input signals accepted by *FieldLogger* and their maximum ranges of measurement are selected in the Configuration software and are listed in the following table.

INPUT TYPE	MEASURING RANGE	ACCURACY
Thermocouple J	-120 to 1000 °C (-184 °F a 1832 °F)	\pm 0.2 % (F.R.) \pm 1 °C
Thermocouple K	-130 to 1372 °C (-202 °F to 2501,6 °F)	\pm 0.2 % (F.R.) \pm 1 °C
Thermocouple T	-130 to 400 °C (-202 °F to 752 °F)	\pm 0.2 % (F.R.) \pm 1 °C
Thermocouple E	-130 a 780 °C (-202 °F to 1436 °F)	\pm 0.2 % (F.R.) \pm 1 °C
Thermocouple N	-130 to 1300 °C (-202 °F to 2372 °F)	\pm 0.2 % (F.R.) \pm 1 °C
Thermocouple R	20 to 1768 °C (68 °F to 3214,4 °F)	\pm 0.2 % (F.R.) \pm 3 °C
Thermocouple S	20 to 1768 °C (68 °F to 3214,4 °F)	\pm 0.2 % (F.R.) \pm 3 °C
Thermocouple B	100 to 1820 °C (212 °F to 3308 °F)	\pm 0.2 % (F.R.) \pm 3 °C
Pt100	-200 to 850 °C (-328 °F to 1562 °F)	\pm 0.15 % (F.R.)
Pt1000	-200 to 850 °C (-328 °F to 1562 °F)	\pm 0.15 % (F.R.)
Linear 0 to 20 mA	Configurable	\pm 0.15 % (F.R.) *
Linear 4 to 20 mA	Configurable	\pm 0.15 % (F.R.) *
Linear 0 to 20 mV	Configurable	\pm 0.15 % (F.R.) *
Linear 0 to 50 mV	Configurable	\pm 0.15 % (F.R.) *
Linear 0 to 60 mV	Configurable	\pm 0.15 % (F.R.) *
Linear -20 to 20 mV	Configurable	\pm 0.15 % (F.R.) *
Linear 0 to 5 V	Configurable	\pm 0.15 % (F.R.) *
Linear 0 to 10 V	Configurable	\pm 0.15 % (F.R.) *

F.R. = Full Range = Span

(*) **Note:** The full scale refers to the input of the sensor signal and not the range of configured indication.

Table 04 - List of signals accepted by *FieldLogger*

Accuracy is guaranteed at intervals of reading greater than 0.2 seconds per channel. For faster read rates (intervals of less than 0.2 seconds), there will be a loss of accuracy that will be as increased as the rate of reading. Likewise, although most of the channels can indicate a little beyond the range limits set, the specification is not guaranteed outside the range.

Input impedance of the analog channels:

- Thermocouples / Pt100 / Pt1000 / mV: > 2 M Ω
- mA: 15 Ω + 1.5 V
- V: 1.1 M Ω

Maximum compensated Pt100/Pt1000 cable resistance: 40 ohms

Excitation current:

- Pt100s: 360 μ A

- Pt1000s: 320 μ A

Pt100/Pt1000 used curves: $\alpha = 0.00385$

Digital Inputs:

- Logical levels:
 - Logical level "0": from 0 to 0.8 Vdc
 - Logical level "1": from 3 to 30 Vdc
- Maximum input voltage: 30 Vdc
- Input Current @ 30 Vdc (typical): 3 mA
- Counting's:
 - Maximum pulse frequency for counting (square wave): 250 Hz
 - Minimum pulse time in logic level "0": 2 ms
 - Minimum pulse time in logic level "1": 2 ms
 - Number of bits for counting: 32

Digital Outputs

- Maximum output voltage: 30 Vdc
- Maximum output current: 200 mA

Relays:

- Maximum Current: 3 A @ 250 Vac; 3 A @ 30 Vdc

Loggings:

- Can log up to 1000 channels per second. Limits: 1 channel at 1000 loggings per second or 100 channels at 10 loggings per second.
- Can log either in the internal flash memory (2162688 bytes \rightarrow approximately 512 k loggings) or in the SD card (*).
- Allows the option of circular logging, where, after filling up the memory, the oldest data will be overwritten by more recent data.
- Allows data to be downloaded during logging.

(* **IMPORTANT:** The effective logging rate depends heavily on the quality and speed of the SD card used. Always prefer to use cards of well-known brands (*SanDisk* and *Kingston*, for example). If the wanted logging rate is high, prefer to use Class IV or above cards.

Maximum number of channels that can be logged: 100

Supported file systems: FAT32 e FAT16, both in USB flash drives and SD cards

24 V output: 24 Vdc \pm 20 % with a minimum load current of 4 mA. Maximum load current: 160 mA. **This output is not provided in the 24 V model!**

Clock battery: Panasonic lithium battery 3 V (Part No. CR 2032).

Supported Modbus commands:

- Read Coil Status (01h)
- Read Holding Registers (03h)
- Write Single Coil (05h)
- Write Single Register (06h)
- Write Multiple Registers (0Fh)

Number of simultaneous TCP connections: 10

Number of simultaneous UDP connections: 10

FTP (*FieldLogger* as a server):

Supported mode: passive.

Standard: UNIX.

Number of simultaneous connections: 1.

SMTP (*e-mail*):

Supported authentication mode: AUTH LOGIN.

Certifications: CE and UL.

SAFETY INFORMATION

Any control system design should take into account that any part of the system has the potential to fail. This product is not a protection or safety device and its alarms are not intended to protect against product failures. Independent safety devices should be always provided if personnel or property are at risk.

Product performance and specifications may be affected by its environment and installation. It is user's responsibility to assure proper grounding, shielding, cable routing and electrical noise filtering, in accordance with local regulations, EMC standards and good installation practices.

SUPPORT AND MAINTENANCE

This product contains no serviceable parts inside. Contact our local distributor in case you need authorized service. For troubleshooting, visit our FAQ at www.novusautomation.com.

LIMITED WARRANTY AND LIMITATION OF LIABILITY

NOVUS warrants to the original purchaser that this product is free from defects in material and workmanship under normal use and service within one (1) year from the date of shipment from factory or from its official sales channel to the original purchaser.

NOVUS liability under this warranty shall not in any case exceed the cost of correcting defects in the product or of supplying replacement product as herein provided and upon the expiration of the warranty period all such liability shall terminate.

For complete information on warranty and liability limitations, check appropriate section in our web site: www.novusautomation.com.