

LUMEL

# POWER NETWORK PARAMETER ANALYSER N10A



SERVICE MANUAL

CE



### CONTENTS

|  |           |
|--|-----------|
| <b>1. APPLICATION</b> .....                                | <b>5</b>  |
| <b>2. METER SET</b> .....                                  | <b>6</b>  |
| <b>3. INSTALLATION</b> .....                               | <b>6</b>  |
| 3.1. FITTING.....  | 6         |
| 3.2. EXTERNAL CONNECTION DIAGRAMS .....                    | 8         |
| <b>4. PROGRAMMING</b> .....                                | <b>13</b> |
| 4.1. FACEPLATE DESCRIPTION.....                            | 13        |
| 4.2. N10A OPERATING MODES.....                             | 14        |
| 4.2.1 MEASURING MODE.....                                  | 15        |
| 4.2.1.1. Measurement of voltage and current harmonics..... | 16        |
| 4.2.2. TIME SETTING MODE - t.....                          | 17        |
| 4.2.3. PARAMETER CONFIGURATION MODE - S.....               | 17        |
| 4.2.4. ALARM CONFIGURATION MODE - A.....                   | 19        |
| 4.2.5. PAGE CONFIGURATION MODE - P .....                   | 19        |
| <b>5. ERROR CODES</b> .....                                | <b>25</b> |
| <b>6. TECHNICAL DATA</b> .....                             | <b>25</b> |
| <b>7. ORDERING CODES</b> .....                             | <b>29</b> |
| <b>8. MAINTENANCE AND WARRANTY</b> .....                   | <b>30</b> |



## 1. APPLICATIONS

The N10A type meter is a programmable digital instrument destined to measure parameters in three-phase three-wire or four-wire power networks, in symmetric and asymmetric systems. The N10A meter is a version of the N10 meter, in which 3 bi-directional analog outputs have been added for customers' needs.

The N10A meter enables the display of measured and calculated quantities (196 in all), the digital transmission of their values and the conversion into three bi-directional analog output signals.

Internal current and voltage transformers ensure the galvanic separation of measured channels.

The N10A meter ensure the measurement of: RMS voltage and current, active, reactive and apparent power, active reactive and apparent energy, power coefficients, frequency, 15-minute average active power.

Voltages and currents are multiplied by voltage and current ratios of measuring transducers what is taking in consideration in calculations and indications of power and energy. The meter shows also the real time.

The RS-485 interface enables the communication with the master system.

Other communication protocols can be realised through the external converter, e.g. the PD7 type with MODBUS/PROFIBUS.

One of the important feature is the possibility to perform the programmed selection of 3 quantities which are converted into bi-directional current signals on 3 analog outputs of the meter.

The relay output can serve to signal the overflow of the chosen quantity threshold.

Measurements are carried out by the sampling method of the voltage and current signal.

The meter is adapted to be fixed in a panel by means of holders.

### **Differences between N10 and N10A meters**

|                         | N10   | N10A  |
|-------------------------|---|---|
| Analog outputs          | 1 output 0...20 mA (4...20 mA)<br>accuracy 0.5% | 3 outputs $\pm 5$ mA (0...5 mA)<br>accuracy 0.2 % |
| Relay outputs           | 3 relays  | 1 relay   |
| Impulse passive outputs | 1 output  | none  |
| Impulse passive input   | 1 input   | none  |

## 2. METER SET

The set includes:

- N10A type meter 1 pc.
- service manual 1 pc.
- warranty card 1 pc.
- holders to fix into a pannel 4 pcs.

Additionally for the execution with interface:

- service manual of the serial interface 1 pc.
- lead of the RS-485 interface 1 pc.
- matching resistor 1 pc.
- diskette for the WIZPAR program 1 pc.

## 3. INSTALLATION

### 3.1. Fitting way

The meter is adapted to be mounted by means of holders according fig.1.

The meter housing is made of a self-extinguishing plastics.

Housing dimensions are 144x144x77mm. At the rear side of the meter there are terminal strips which enable the connection of 2.5 mm<sup>2</sup> external leads.

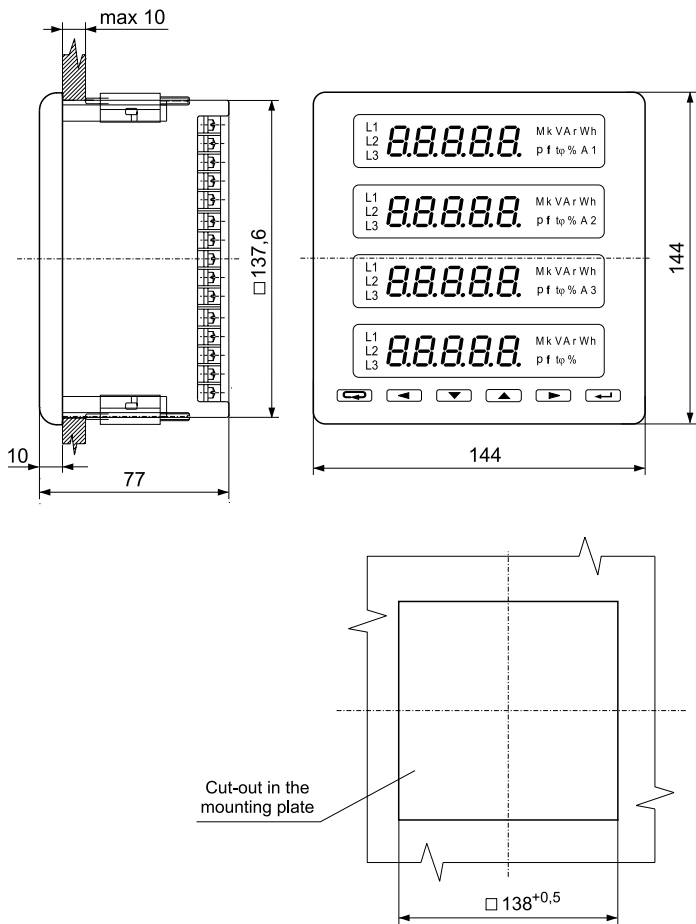
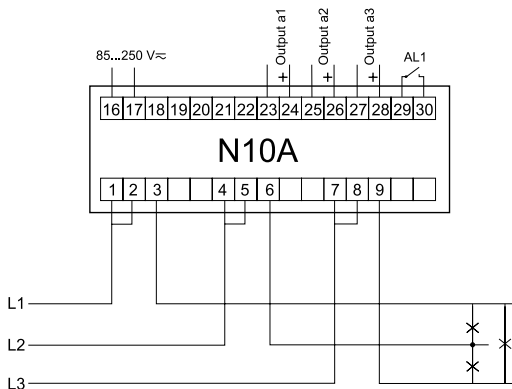
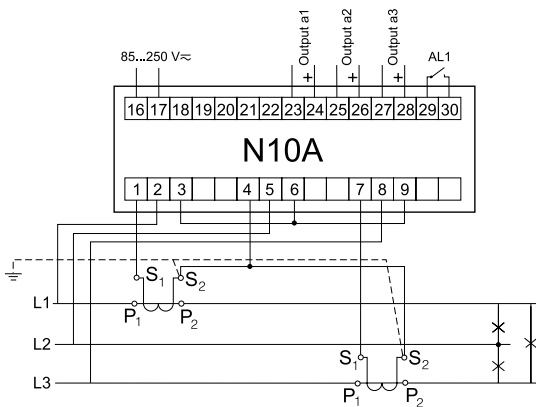

Fig.1 Overall dimensions and fitting way of the N10A meter.

### 3.2. External connection diagrams



Direct measurement in a 3-phase network



Half-intermediate measurement in a 3-phase network



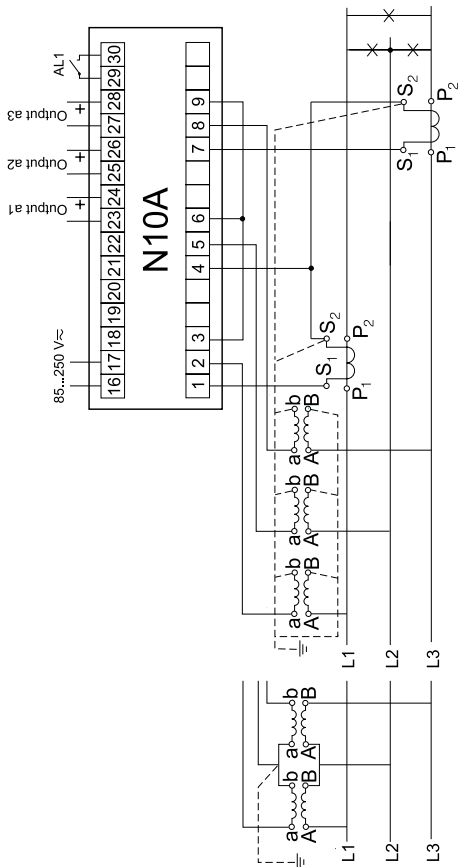

Intermediate measurement using 2-current transformers and 2 or 3 voltage transformers in a 3-phase network

Fig. 2. Meter connection diagrams in a three-phase network

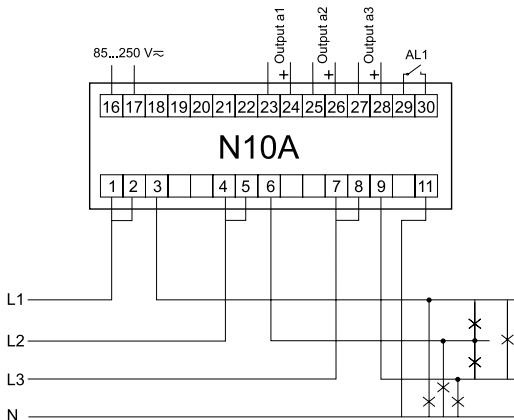

Direct measurement in a 4-wire network

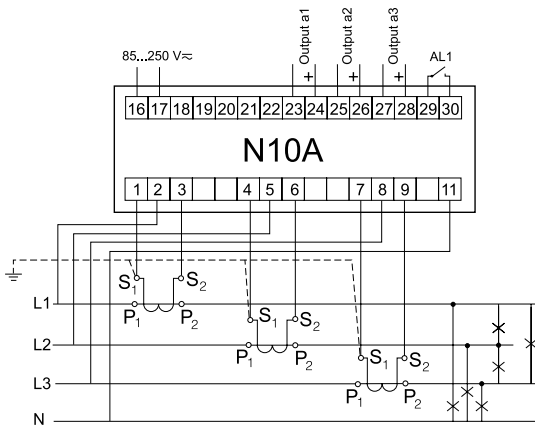

Half-intermediate measurement in a 4-wire network

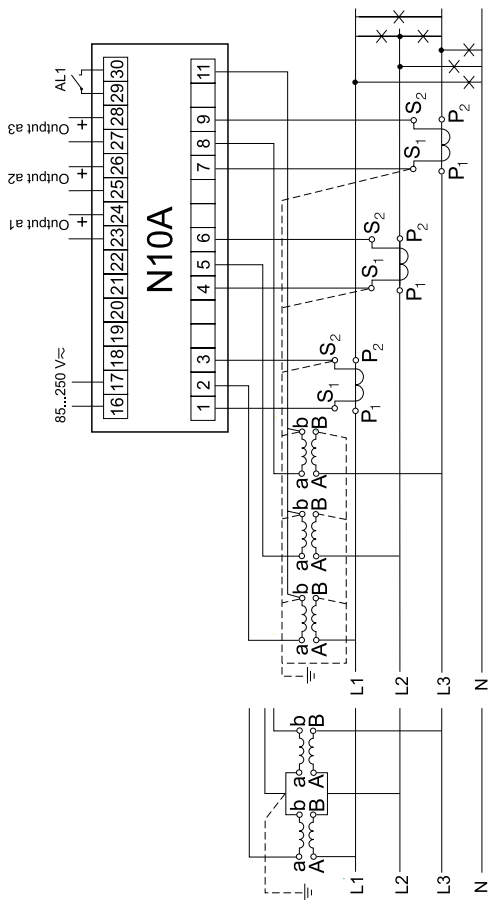
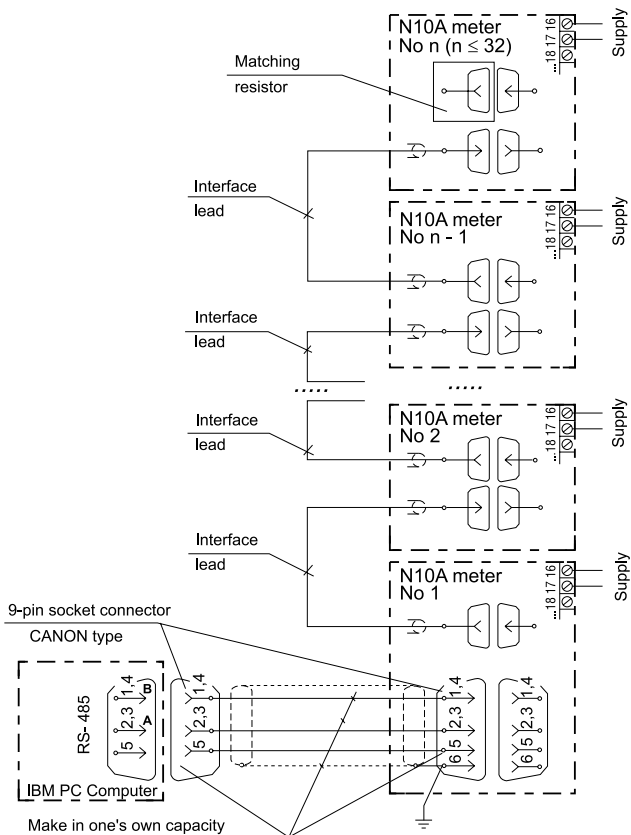

Fig. 3. Meter connection diagrams in a four-wire network

Intermediate measurement using 2-current transformers and 2 or 3 voltage transformers in a 4-wire network



**NOTICE:**

To make the IBM PC - N10A meter (RS-485) connection it is recommended to use a double-wire twisted conductor in a shield. The shield should be connected to the earth in one point. The shield is necessary when the environment is very perturbed.

Fig. 4. Connecting way of N10A meters with an RS-485 interface.

## 4. PROGRAMMING

### 4.1. Faceplate description

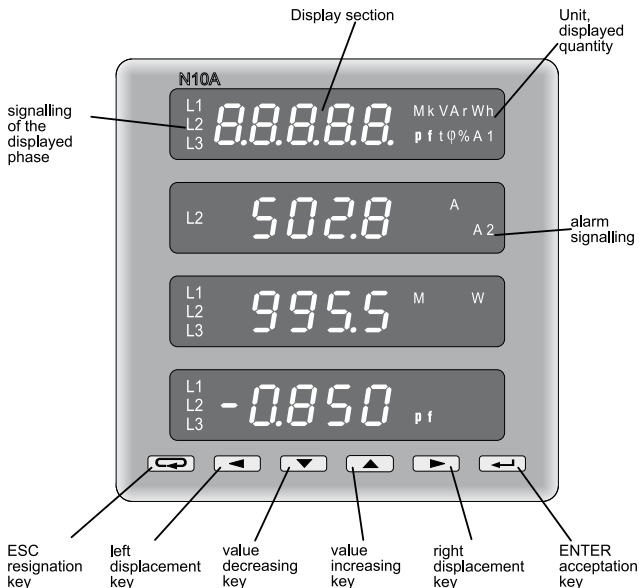



Fig. 5. View of the N10A meter faceplate

The N10A meter has 6 keys, four 5-digits display sections, illuminated symbols and parameter units. Values of measured parameters are shown on active pages selected by successive pressures of the  key.

A page consists of 4 optional quantities chosen from the table 5 and displayed simultaneously on the meter.

The page definition is described in the configuration mode P.

Table 1.

The assignment of individual keys is as follows:



**Key**

It is destined to accept the introduced value during the programming.

It enables the change of pages in the measuring mode.

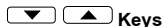

**Keys**

They are destined to change the digit value on the decimal position during the programming.

They enable the display of suitably minimal and maximal values in the measurement mode.



**Keys**

They allow the cursor displacement to successive decimal positions during the programming and enable the change of display luminosity in the SETUP procedure.



**Key**

This key enables in anytime the resignation of carried out operations. It cancels alarms in measuring mode.

|   |  |                  |
|---|--|------------------|
| 1 |  | acceptance key   |
| 2 |  | displacement key |
| 3 |  | increase key     |
| 4 |  | decrease key     |
| 5 |  | displacement key |
| 6 |  | resignation key  |

## 4.2. N10A operating modes

The N10A meter has 5 operating modes represented on the table 2.

Table 2

| MODE                                   |                    |                    |                               |
|--|--------------------|--------------------|-------------------------------|
| NAME                                   | CALLING OUT SYMBOL | INPUT              | OUTPUT                        |
| Measuring                              |                    | default            | Through entry to another mode |
| Time setting                           | <b>t</b>           | in SETUP procedure | or  after the last parameter  |
| Page configuration                     | <b>P</b>           | in SETUP procedure | or  after the last page       |
| Parameter configuration                | <b>S</b>           | in SETUP procedure | or  after the last parameter  |
| Alarm configuration and analog outputs | <b>A</b>           | in SETUP procedure | or  after the last parameter  |

After its switching on, the meter carries out tests informing by a message:

|  |           |           |          |          |
|--|-----------|-----------|----------|----------|
|  | <b>n</b>  | <b>1</b>  | <b>0</b> | <b>A</b> |
|  |           |           |          |          |
|  |           |           |          |          |
|  | <b>r.</b> | <b>1.</b> | <b>0</b> | <b>1</b> |

where: r.1.01 - No of the actual program version

After tests carrying out, the meter enters into the measuring mode and displays the page positioned before switching off.

The entry into another mode is made in the SETUP procedure. In order to enter in the SETUP procedure one should press two keys:



during ca 3 seconds, until the audible signal will be switched off.

|  |          |  |  |                 |
|--|----------|--|--|-----------------|
|  | <b>S</b> |  |  | <b>t</b>        |
|  | <b>E</b> |  |  | <b><u>P</u></b> |
|  | <b>t</b> |  |  | <b>S</b>        |
|  |          |  |  | <b>A</b>        |

Choose by means of keys the appropriate mode. The active mode t, P, S or A is signalled by the flashing of the suitable symbol. Accept the chosen mode by the key.

The return from other modes into the measuring mode is carried out by means of the or key:



- after the last parameter (in t, S and A modes),
- after the last page (in the P mode).

#### 4.2.1. Measuring mode

Values of different quantities are displayed acc. programmed pages by the manufacturer or configured by the user in the **P** mode.





The change of page is realized by pressing the Key. The sequence of displayed pages is proceeded acc. the table formed in the **P** mode.

The monitoring of maximal or minimal values is realized when pressing respectively the or key. The cancellation of maximal or minimal values is realized when pressing the key during the monitoring of these values, i.e. at first the

 or  key must be pressed and after the key.



Alarm is active if it was allocated. One must notice that the alarm do not need to be related to quantities displayed on the page, because a change of page would cause an action on the two-state output.

#### 4.2.1.1. Measurement of voltages and current harmonics

The selection of harmonics is made by pressing   keys for reviewing current harmonics, or by   keys for reviewing voltage harmonics.





|  |   |  |   |          |
|--|---|--|---|----------|
|  | H |  | I | 1        |
|  | A |  | I | <u>2</u> |
|  | r |  | I | 3        |
|  |   |  |   |          |

|  |   |  |   |          |
|--|---|--|---|----------|
|  | H |  | U | 1        |
|  | A |  | U | <u>2</u> |
|  | r |  | U | 3        |
|  |   |  |   |          |

The selected **U1,U2,U3** or **I1,I2, I3** quantity is signalled by the flashing of the suitable digit. One must choose by the  or  key the required quantity and press the  key. The following quantities will be displayed:

|  |   |   |    |          |
|--|---|---|----|----------|
|  |   | w | -  | n        |
|  |   |   |    |          |
|  | h |   | n  | <u>n</u> |
|  | x | x | x. | x        |

Where: w-n - chosen quantity, e.g. U-1  
 n-n - harmonic number  
 xxx.x - value of the n-th harmonic

The harmonic number up to the 25th harmonic can be changed by means of  or  keys. The active position is signalled by the cursor. One can return to display the selection of reviewed harmonics by pressing the  key. A successive pressure of the  key means the return to the measuring mode.



For wrong THD indications, successive harmonic values will not be displayed.

#### NOTICE:

Indications appear when the parameter 15 will be switch on in the SETUP mode, i.e. the selection of the harmonic measurement and the assumptions concerning their measurements will be fulfilled.













### 4.2.2. Setting time mode - t

After the entry into the SETUP procedure one must choose the mode t by pressing the  or  key and the  key. Following values will be displayed:

|  |   |   |   |   |
|--|---|---|---|---|
|  | y | y | y | y |
|  |   |   | m | m |
|  |   |   | d | d |
|  |   |   |   |   |

Where: yyyy - year  
mm - month  
dd - day

By means of     keys required values can be set, i.e. the position of the decimal digit can be chosen by the  or  key, the digit value by the  or  key. The cursor signals the active position. The set value can be accepted by the  key or cancelled by the  key and comes back into the measuring mode.



 causes the setting on the successive parameter.

 after dd (day), causes the transition to hours and minutes settings.

|  |  |  |   |   |
|--|--|--|---|---|
|  |  |  | h | h |
|  |  |  | m | m |
|  |  |  | s | s |
|  |  |  |   |   |

Where: hh - hours  
mm - mminutes  
ss - secondes

The setting of hours and minutes is similar to the setting of the year, month and day.

 after min (minutes), causes the memorization of set values and the exit from the mode t. The second counter is not be set but it is zeroed when accepting minutes. This means that in order to obtain an accurate timer setting one must wait till a full minute and then press the  key (ENTER).

### 4.2.3. Parameter configuration mode - S

This mode is destined to set meter parameters, input and output signal values. The entry into the parameter configuration mode is protected by the access code if an access code different from zero had been introduced.

In the case of 0000 code, password inquiry is omitted. If the access code is different from zero, there is the possibility of parameter reviewing, but changes are locked. Values are set in this mode acc. to the table 3.

Table 3

| Item | Parameter name  | Designation | Range              | Notice/<br>description  | Manufacturer's<br>values |
|------|---|-------------|--------------------|---|--------------------------|
| 1    | Introduction of access code   | SECU        | 0000... 9999       | 0000 - without code   | 0000                     |
| 2    | Setting of meter parameters by the manufacturer                             | rESt        |                    | Y/n   | n                        |
| 3    | Ratio of current transformer  | tr_I        | 1... 20000         |   | 1                        |
| 4    | Ratio of voltage transformer  | tr_U        | 1... 4000          |   | 1                        |
| 5    | Quantity on the continuous output   | Ao_n        | 0... 34            | Quantity code acc. table 5  | 1                        |
| 6    | Cancellation of the active energy counter                                   | EnP0        |                    | Y/n   | n                        |
| 7    | Cancellation of the reactive energy counter                                 | Enq0        |                    | Y/n   | n                        |
| 8    | Cancellation of the apparent energy counter                                 | EnS0        |                    | Y/n   | n                        |
| 9    | Cancellation of the 15-minu-tes active power $P_{AV}$ (max. and min. Value) | PA_0        |                    | Y/n   | n                        |
| 10   | Averaging time of $P_{AV}$ power  | PA_t        | 15,30,60 min.      |   | 15                       |
| 11   | synchronization of the $P_{AV}$ power averaging to the virtual timer        | PA_S        |                    | Y/n   | Y                        |
| 12   | Meter address in the system   | Adr         | 1... 247           |   | 1                        |
| 13   | Speed of the serial interface   | bAUd        | 300,600,..., 19200 |   | 19200                    |
| 14   | Interface working mode  | trYb        | 0, 1, ...,6        | 0 -switched off interface<br>1 - MODBUS ASCII 8N1<br>2 - MODBUS ASCII 7E1<br>3 - MODBUS ASCII 7O1<br>4 - MODBUS RTU 8N2<br>5 - MODBUS RTU 8E1<br>6 - MODBUS RTU 8O1 | 0                        |
| 15   | Selection of the harmonic measurement                                       | Har         | 0.1                |   | 0                        |
| 16   | Change of the access code   |             | 0000... 9999       |   | 0000                     |









In parameters 5, 14 the range 0 means that the appropriate output, or interface switched off.



**Notations:**

N - lack of parity (no parity),

E - bit checking the even parity,

O - bit checking the odd parity.

The entry into the procedure causes the setting on the parameter 1 or 2 if the access code is equal 0000. We adjust required values by means of     keys, i.e. one can choose the position of the decimal digit by pressing the  or  key, the digit value by pressing the  or  key. The active position is signalled by the cursor.

One can accept the established value by pressing the  key or cancel it by pressing the  key and come back to the measuring mode.

 causes the setting on the successive parameter.

 after the last parameter, causes the memorization of setting values and the exit from the mode S.

**Notice:**

**PA\_S=Y** means that the average power  $P_{AV}$  will be brought up to date every 15, 30, or 60 minutes synchronized with the internal virtual timer.

**PA\_S=n** means that the average power will be calculated for the last 15, 30, or 60 minutes and brought up to date every 1 second, so-called „moving window”.

#### **4.2.4. Alarm configuration mode - A**

This mode serves to:

- attribute the quantity to alarms,
- Set the thresholds setting of alarm switching on and off (also the direction of alarm action).
- set the latency of alarm operation,
- assign any quantity of the group of 34 parameters (acc. to table 5) of continuous output current signal,
- set the changing window of the input signal.

Table 4

| Item | Parameter name                         | Designation | Range          | Notice/<br>description         | Manufacturer's<br>values |
|------|--|-------------|----------------|--------------------------------|--------------------------|
| 1    | Two-state output 1 - quantity          | A1_n        | 0, 1... 34     | Quantity code acc.<br>table 5  | 2                        |
| 2    | Two-state output 1 - switch on value   | A1on        | 0... 120 [%]   |                                | 101                      |
| 3    | Two-state output 1 - switch on value   | A1oF        | 0... 120 [%]   |                                | 99                       |
| 4    | Delay in the alarm operation           | ALdt        | 0... 100 sec   | Delay of alarm<br>switching on | 0                        |
| 5    | Quantity on the continuous output nr 1 | Ao_1        | 0, 1... 34     | Quantity code acc.<br>table 5  | 0 (off)                  |
| 6    | Lower value of the input range         | AoL1        | -120...0...120 |                                | - 100                    |
| 7    | Upper value of the input range         | AoH1        | -120...0...120 |                                |                          |
| 8    | Quantity on the continuous output nr 2 | Ao_2        | 0, 1... 34     | Quantity code acc.<br>table 5  | 0 (off)                  |
| 9    | Lower value of the input range         | AoL2        | -120...0...120 |                                | - 100                    |
| 10   | Upper value of the input range         | AoH2        | -120...0...120 |                                |                          |
| 11   | Quantity on the continuous output nr 3 | Ao_3        | 0, 1... 34     | Quantity code acc.<br>table 5  | 0 (off)                  |
| 12   | Lower value of the input range         | AoL3        | -120...0...120 |                                | - 100                    |
| 13   | Upper value of the input range         | AoH3        | -120...0...120 |                                |                          |

The entry into the mode of alarm setting is not protected by the access code.

Alarms are active if they were attributed, i.e. if a measured quantity different than zero (table 5) has been attributed to them. One must notice that alarms concern chosen quantities in the basic configuration mode S **and they are not related with quantities displayed on the page**. If the quantity value related to the alarm exceeds the declared threshold, the two-state output corresponding to this alarm will be switched on (relay) and the symbol A1 will be lighted. If the quantity value decreases below the alarm threshold, the two-state output is switched off, but the A1 signalling remains until the time of its cancellation by means of the **ESC** key.

The A1on < A1oF setting causes the alarm inverse action, i.e. the output is switched on if the prescribed value decreases below the A1on value and the output is switched off if the value, increases above the A1oF threshold.

Analog outputs for parameters accepting values:

- **positive and negative** (table 5), are bi-directional, i.e., for negative parameter values, the analog output signal is also negative,
- **positive**, they are unidirectional, i.e., for positive parameter values, the analog output signal is positive (from the range: 0...+ 5 mA).

#### 4.2.5. Page configuration mode - P

This mode is used to select quantities displayed simultaneously on the meter, i.e. to define user's pages.

A list of possible quantities and their codes are inserted in the table 5.

Table 5.

| Code | Quantity name                              | Symbol | Unit     | Signalling | Mark |
|------|--|--------|----------|------------|------|
| 00   | Without quantity - display extinguished    |        |          |            |      |
| 01   | Phase 1 voltage                            | U1     | (k)V     | L1         |      |
| 02   | Line L1 curren                             | I1     | (k)A     | L1         |      |
| 03   | Phase L1 active power                      | P1     | (M,k)W   | L1         | /-   |
| 04   | Phase L1 reactive power                    | Q1     | (M,k)V   | ArL1       | /-   |
| 05   | Phase L1 apparent power                    | S1     | (M,k)VA  | L1         |      |
| 06   | Phase L1 active power factor (Pf1= P1/ S1) | Pf1    | Pf       | L1         | /-   |
| 07   | Phase L1 tφ1 factor (tφ1= Q1/ P1)          | tφ1    | tφ       | L1         | /-   |
| 08   | Phase L2 voltage                           | U2     | (k)V     | L2         |      |
| 09   | Line L2 current                            | I2     | (k)A     | L2         |      |
| 10   | Phase L2 active power                      | P2     | (M,k)W   | L2         | /-   |
| 11   | Phase L2 reactive power                    | Q2     | (M,k)VAr | L2         | /-   |
| 12   | Phase L2 apparent power                    | S2     | (M,k)VA  | L2         |      |
| 13   | Phase L2 active power factor (Pf2= P2/S2)  | Pf2    | Pf       | L2         | /-   |
| 14   | Phase L2 tφ2 factor (tφ2= Q2/P2)           | tφ2    | tφ       | L2         | /-   |
| 15   | Phase 3 voltage                            | U3     | (k)V     | L3         |      |
| 16   | Line L3 current                            | I3     | (k)A     | L3         |      |
| 17   | Phase L3 active power                      | P3     | (M,k)W   | L3         | /-   |
| 18   | Phase L3 reactive power                    | Q3     | (M,k)VAr | L3         | /-   |
| 19   | Phase L3 apparent power                    | S3     | (M,k)VA  | L3         |      |
| 20   | Phase L3 active power factor (Pf3= P3/S3)  | Pf3    | Pf       | L3         | /-   |
| 21   | Phase L3 tφ3 factor (tφ3= Q3/P3)           | tφ3    | tφ       | L3         | /-   |
| 22   | Average 3-phase voltage                    | Us     | (k)V     | 1,2,3      |      |





Table 5.

| Code | Quantity name                         | Symbol           | Unit                   | Signalling | Mark |
|------|---------------------------------------|------------------|------------------------|------------|------|
| 23   | Average 3-phase current               | Is               | (k)A                   | L1,L2,L3   |      |
| 24   | 3-phase active power                  | P                | (M,k)W                 | L1,L2,L3   | /-   |
| 25   | 3-phase reactive power                | Q                | (M,k)VA <sub>r</sub>   | L1,L2,L3   | /-   |
| 26   | 3-phase apparent power                | S                | (M,k)VA                | L1,L2,L3   |      |
| 27   | Active power factor (Pf= P/ S)        | Pf               | Pf                     | L1,L2,L3   | /-   |
| 28   | Average 3-phase tφ factor (tφ= Q/P)   | tφ               | tφ                     | L1,L2,L3   | /-   |
| 29   | Frequency                             | f                | Hz                     |            |      |
| 30   | Voltage between lines L1-L2           | U <sub>12</sub>  | (k)V                   | L1,L2      |      |
| 31   | Voltage between lines L2-L3           | U <sub>23</sub>  | (k)V                   | L2,L3      |      |
| 32   | Voltage between lines L3-L1           | U <sub>31</sub>  | (k)V                   | L3,L1      |      |
| 33   | Average between lines voltage         | U <sub>123</sub> | (k)V                   | L1,L2,L3   |      |
| 34   | 15-minutes average active power       | PAV              | (M,k)W                 | 1, 2, 3    |      |
| 35   | 3-phase active energy                 | EnP              | (M,k)Wh                | L1,L2,L3   | /-   |
| 36   | 3-phase reactive energy               | Enb              | (M,k)VA <sub>r</sub> h | L1,L2,L3   | /-   |
| 37   | 3-phase apparent energy               | EnS              | (M,k)VAh               | L1,L2,L3   |      |
| 38   | Active energy from external counter   | EnPz             | (M,k)Wh                |            |      |
| 39   | Reactive energy from external counter | Enbz             | (M,k)VA <sub>r</sub> h |            |      |
| 40   | Apparent energy from external counter | EnSz             | (M,k)VA                |            |      |
| 41   | Date - day, month                     |                  |                        |            |      |
| 42   | Date - year                           |                  |                        |            |      |
| 43   | Time - hours, minutes                 |                  |                        |            |      |
| 44   | Time - secondes                       |                  |                        |            |      |
| 45   | THD of the phase L1 voltage           | THD U1           | V%                     | L1         |      |
| 46   | THD of the phase L2 voltage           | THD U2           | V%                     | L2         |      |
| 47   | THD of the phase L3 voltage           | THD U3           | V%                     | L3         |      |
| 48   | THD of the phase L1 current           | THD I1           | A%                     | L1         |      |
| 49   | THD of the phase L2 current           | THD I2           | A%                     | L2         |      |
| 50   | THD of the phase L3 current           | THD I3           | A%                     | L3         |      |

In the case of parameters 45...50, the denominations V and A have got a conventional character distinguishing the given parameter, the basic quantity in %.

In order to define pages one must enter into the mode **P**.

|  |          |          |          |          |
|--|----------|----------|----------|----------|
|  | <b>P</b> | <b>A</b> | <b>G</b> | <b>n</b> |
|  |          |          |          |          |
|  |          |          |          |          |
|  |          |          | <b>n</b> | <b>n</b> |

By pressing     keys set the number nn of user's pages from the range 00... 20. Accept by the  key the chosen mode.

If the number of pages is set 00, it means that the user did not decide to define own pages and chose 7 pages programmed by the manufacturer. Manufacturer's settings are shown below:





| Page 1 |                     | Page 2 |                       | Page 3 |                     | Page 4 |                      |
|--------|---------------------|--------|-----------------------|--------|---------------------|--------|----------------------|
| 01     | U <sub>1</sub> (k)V | 30     | U <sub>12</sub> (k)V  | 02     | I <sub>1</sub> (k)A | 03     | P <sub>1</sub> (Mk)W |
| 08     | U <sub>2</sub> (k)V | 31     | U <sub>23</sub> (k)V  | 09     | I <sub>2</sub> (k)A | 10     | P <sub>2</sub> (Mk)W |
| 15     | U <sub>3</sub> (k)V | 32     | U <sub>31</sub> (k)V  | 16     | I <sub>3</sub> (k)A | 17     | P <sub>3</sub> (Mk)W |
| 22     | U <sub>s</sub> (k)V | 33     | U <sub>123</sub> (k)V | 23     | I <sub>s</sub> (k)A | 24     | P (Mk)W              |
| Page 5 |                     | Page 6 |                       | Page 7 |                     |        |                      |
| 24     | P (Mk) W            | 35     | EnP (Mk) Wh           | 41     | dd.mm               |        |                      |
| 25     | Q (Mk) VAr          | 36     | EnB (Mk) VArh         | 42     | yyyy                |        |                      |
| 26     | S (Mk) VA           | 37     | EnS (Mk) VAh          | 43     | hh.mm               |        |                      |
| 27     | Pf                  | 38     | f                     | 44     | ss                  |        |                      |



If a non-zero number of pages has been set then one must define the page con-

|  |          |  |          |          |
|--|----------|--|----------|----------|
|  | <b>P</b> |  | <b>k</b> | <b>k</b> |
|  | <b>G</b> |  | <b>k</b> | <b>k</b> |
|  | <b>n</b> |  | <b>k</b> | <b>k</b> |
|  | <b>n</b> |  | <b>k</b> | <b>k</b> |

nn - page number

kk - quantity code acc. to the table 5.

By pressing     keys, set required quantities on successive display sections.

The active position is signaled by the cursor. One can accept the established value by the  key or cancel it by pressing the  key

 causes the setting on the next parameter or the successive page.

 after the last page, causes the memorization of pages and the exit from the configuration mode P.

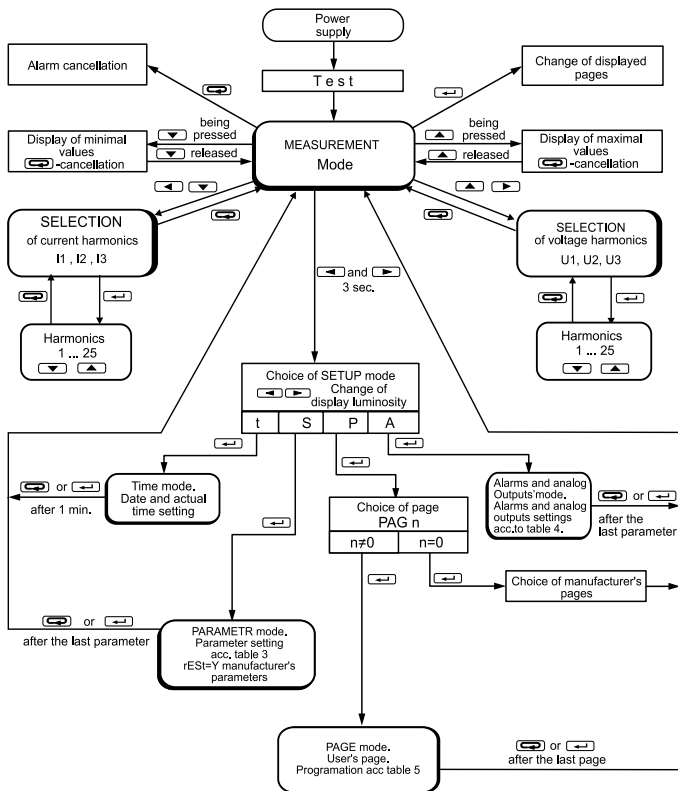

Fig.6 N10A meter working modes.



## 5. ERROR CODES

During the meter operation, communicating concerning errors can occur.

Causes of errors are presented below:

Err1 - when the voltage or the current is too low during the measurement:

Pfi ,t<sub>pi</sub> below 7% U<sub>n</sub>

and (or) below 2% I<sub>n</sub>

f below 0,5%

THD U<sub>i</sub>, THD I<sub>i</sub>, below 1% U<sub>n</sub>, I<sub>n</sub>

or the full interval of the PA\_t averaging time is not elapsed yet,

Err2 - Lack of possibility to define the maximal or minimal quantity value (lack of current, usually after the meter switching on or the cancellation of extremal values)

Lo F - frequency lower than 47 Hz for THD U<sub>i</sub>, THD I<sub>i</sub> measurements,

Hi F - frequency higher than 52 Hz for THD U<sub>i</sub>, THD I<sub>i</sub> measurements.

## 6. TECHNICAL DATA

Measuring ranges and admissible basic errors are shown on the table 6

### Power consumption:

- supply circuit ≤ 12 VA

- voltage circuit ≤ 0.5 VA

- current circuit ≤ 0.1 VA

### Supply

85...253 V d.c. or a.c., 40...400 Hz

### Display section:

4 x 5 LED digits, 14 mm high,  
red or green digits

### Outputs:

- analogue outputs 3 analog outputs: -5... 0...+5 mA  
accuracy: 0.2%

- relay outputs 1 relay voltageless make contacts,  
load capacity: 250 V a.c./ 0.5 A a.c.

### Measurement of the harmonics

(Up to the 25 th) for currents and voltages

### THD - Total Harmonic Distortion

for currents and voltages

Table 6

| Measured quantity  | Range   | Basic error                  | remarks   |
|--|---|------------------------------|---|
| U <sub>i</sub> voltage   | 100.0 V (Ku=1)<br>400.0 V (Ku=1)<br>for Ku≠1... 400.0 kV                | ± (0.2% m.v.<br>+0.1% range) | Ku = 1...4000   |
| I <sub>i</sub> current   | 1.000 A (Ki=1)<br>5.000 A (Ki=1)<br>for Ki≠1... 20.00 kA                | ± (0.2% m.v.<br>+0.1% range) | Ki = 1... 20000   |
| P <sub>i</sub> active power P <sub>AV</sub><br>mean active power<br>Active energy EnP,<br>EnPz | 0.0... (-)1999.9 W (Wh)<br>for Ku≠1, Ki≠1<br>...(-)1999.9 MW (MWh)      | ± (0.5% m.v.<br>+0.2% range) |   |
| S <sub>i</sub> apparent power.<br>Apparent energy<br>EnS, EnSz                                 | 0.0... 1999.9 VA (VAh)<br>for Ku≠1, Ki≠1<br>...1999.9 MVA (MVAh)        | ± (0.5% m.v.<br>+0.2% range) |   |
| Q <sub>i</sub> reactive power.<br>Reactive energy<br>EnQz                                      | 0.0... (-)1999.9 Var (Varh)<br>for Ku≠1, Ki≠1<br>(-)1999.9 MVar (MVarh) | ± (0.5% m.v.<br>+0.2% range) |   |
| Pf <sub>i</sub> active power<br>factor   | - 1.00 ...0.00 ...1.000   | ± 1% m.v. ±2c                | Pf=Power<br>factor=P/S                                  |
| tgφ <sub>i</sub> factor (ratio of<br>reactive power to<br>active power)                        | - 99.9...0...99.9   | ± 1% m.v. ±2c                | Error<br>in the range:<br>- 99.9...0...99.9             |
| f frequency  | 15.0... 500.0 Hz  | ± 0.5% m.v.                  |   |
| THD U, THD I<br>harmonics  | 0.2... 200%   | ± 0.5% m.v. ±2c              | Error<br>in the range:<br>10...120% U, I<br>47... 52 Hz |

Where: Ku - voltage transformer ratio

Ki - current transformer ratio

m.v. - measured value

c - less significant display digit

THD U - full distortion factor (by voltage harmonics)

THD I - full distortion factor (by current harmonics)

|   |  |
|---|--|
| <b>Serial interface</b>                                       | RS-485   |
| <b>Transmission protocol</b>                                  | MODBUS   |
| <b>Meter reaction to decays and supply recovery:</b>          | <ul style="list-style-type: none"> <li>● data and meter state preservation during supply decays, (battery support),</li> <li>● work continuation after supply recovery</li> </ul>  |
| <b>Degree of protection ensured by the housing:</b>           |  |
| - frontal side  | IP 40  |
| - rear side   | IP 10  |
| <b>Weight</b>   | 0.8 kg   |
| <b>Overall dimensions</b>                                     | 144 × 144 × 77 mm  |
| <b>Panel cut-out dimensions</b>                               | 138 <sup>+0.5</sup> × 138 <sup>+0.5</sup>  |
| <b>Reference conditions and nominal operation conditions:</b> |  |
| - Input signal:   | <p>0...<u>0.01</u>...<u>1.2</u> In; 0...<u>0.01</u>...<u>1.2</u> Un, for voltage, current, frequency, power and energy</p> <p>0...<u>0.02</u>...<u>1.2</u> In; 0...<u>0.07</u>...<u>1.2</u> Un, for Pf and tp factors, frequency 15...<u>45</u>...<u>65</u>...500 Hz<br/>sinusoidal input signal ≤ 8%</p> <p>0.1...1.2 In; 0.1...1.2 Un; 47... 52 Hz, for THDU, THDI and harmonics</p> |
| - power factor  | - 1...0...1  |
| - ambient temperature   | 0... <u>23</u> ...55°C   |
| - air humidity  | 25...95% (no condensation)   |
| - power supply  | 85... 253 V d.c. or a.c. 40... 400 Hz  |
| - admissible peak factor:                                     |  |
| - current   | 2  |
| - voltage   | 2  |
| - external magnetic field                                     | <u>0...40</u> ...400 A/m   |
| - short duration overload (5 sec):                            |  |
| - voltage inputs  | 2 Un (max.1000 V)  |
| - current inputs  | 10 In  |
| - working position  | optional   |
| - warm-up time  | 5 minutes  |

**Additional errors in % of the basic error:**

- input signal frequency < 50%
- ambient temperature changes < 50%/10°C

**Electromagnetic compatibility:**

- immunity acc. EN 61000-6-2
- emission acc. EN 61000-6-4

**Safety requirements:**

- acc. EN 61010-1+A1
- insulation ensured by the housing dual
- insulation between circuits basic
- installation category III
- pollution degree 2
- maximal working voltage relation to earth 600 V a.c.

## 7. ORDERING CODES

| NETWORK PARAMETER METER - N10A               | X | X | X | X | X | XX | X |
|--|---|---|---|---|---|----|---|
| <b>Input <math>I_n</math> current:</b>       |   |   |   |   |   |    |   |
| 1A ( X/1 )                                   | 1 |   |   |   |   |    |   |
| 5A ( X/5 )                                   | 2 |   |   |   |   |    |   |
| acc. order *                                 | 9 |   |   |   |   |    |   |
| <b>Input phase voltage <math>U_n</math>:</b> |   |   |   |   |   |    |   |
| 100 V  | 1 |   |   |   |   |    |   |
| 400 V  | 2 |   |   |   |   |    |   |
| acc. order *                                 | 9 |   |   |   |   |    |   |
| <b>Digital output:</b>                       |   |   |   |   |   |    |   |
| without interface                            |   |   |   | 0 |   |    |   |
| with RS-485 interface                        |   |   |   | 1 |   |    |   |
| <b>Displays:</b>                             |   |   |   |   |   |    |   |
| red digits                                   |   |   |   | 1 |   |    |   |
| green digits                                 |   |   |   | 2 |   |    |   |
| <b>Power supply:</b>                         |   |   |   |   |   |    |   |
| 85...250 V d.c., a.c., 40...400 Hz           |   |   |   |   | 0 |    |   |
| acc. order*                                  |   |   |   |   | 9 |    |   |
| <b>Version:</b>                              |   |   |   |   |   |    |   |
| standard                                     |   |   |   |   |   | 00 |   |
| custom-made                                  |   |   |   |   |   | 99 |   |
| <b>Acceptance test:</b>                      |   |   |   |   |   |    |   |
| without additional requirements              |   |   |   |   |   |    | 8 |
| with a quality inspection certificate        |   |   |   |   |   |    | 7 |
| acc. customer's agreement **                 |   |   |   |   |   |    | X |

\* after agreement with the manufacturer.

\*\* the code numbering will be made by the manufacturer.

## ORDERING EXAMPLE:

code **N10A-2-1-1-2-0-00-1**-means: input range: 5 A, 100 V, RS-485 interface, green displays, power supply: 85...250 V d.c./a.c., standard version, with a quality inspection certificate.

## 8. MAINTENANCE AND WARRANTY

The N10A meter does not require any periodical maintenance.

In case of some incorrect unit operations:

### 1. In the period of 12 months from the date of purchase:

One should take the meter down from the installation and return it to the LUMEL's Quality Control Dept.

If the unit has been used in compliance with the instructions, LUMEL S.A. warrants to repair it free of charge.

### 2. After the warranty period:

One should turn over the meter to repair in a certified service workshop.

The disassembling of the housing causes the cancellation of the granted guarantee.

Spare parts are available for the period of ten years from the date of purchase.

**LUMEL S.A. reserves the right to make changes in design and specifications of any products as engineering advances or necessity requires.**



## **SALES PROGRAM**

- DIGITAL and BARGRAPH PANEL METERS
- MEASURING TRANSDUCERS
- ANALOG PANEL METERS (DIN INSTRUMENTS)
- ANALOG and DIGITAL CLAMP-ON METERS
- INDUSTRIAL and HOUSEHOLD CONTROLLERS
- CHART AND PAPERLESS RECORDERS
- POWER CONTROL UNITS and INVERTERS
- LARGE SIZE NUMERIC and ALPHANUMERIC DISPLAYS
- AUTOMOTIVE DASHBOARD INDICATORS
- ACCESSORIES FOR MEASURING INSTRUMENTS
- MEASURING SYSTEMS (ENERGY, HEAT, CONTROL)
- CUSTOM-MADE PRODUCTS

***MEASUREMENT  
CONTROL  
RECORDING***

## **WE ALSO OFFER OUR SERVICES IN THE PRODUCTION OF:**

- ALUMINIUM ALLOY PRESSURE CASTINGS
- PRECISION ENGINEERING AND THERMOPLASTICS PARTS
- PRESSURE CASTING DIES AND OTHER TOOLS

## **QUALITY PROCEDURES:**

According to ISO 9001 and ISO 14001 international requirements.

All our instruments have CE mark .

For more information, please write to or phone our Export Department



## **Lubuskie Zakłady Aparatów Elektrycznych LUMEL S.A.**

ul. Sulechowska 1

65-022 Zielona Góra - Poland

Tel.: (48-68) 32 95 100 (exchange)

Fax: (48-68) 32 95 101

e-mail: [lumel@lumel.com.pl](mailto:lumel@lumel.com.pl)

<http://www.lumel.com.pl>

## **Export Department:**

Tel.: (48-68) 32 95 302 or 04

Fax: (48-68) 325 40 91

e-mail: [export@lumel.com.pl](mailto:export@lumel.com.pl)