

LUMEL

# TEMPERATURE CONTROLLER RE21 TYPE



USER'S MANUAL





## Contents

1. Application .....	5
2. Controller set .....	5
3. Preparation of the controller to work .....	6
3.1. Safety .....	6
3.2. Controller installation .....	9
3.3. Electrical connection .....	10
3.4. Installation recommendations .....	11
4. Starting to work .....	12
5. Programming of controller parameters .....	13
5.1. Scheme of the controller menu .....	13
5.2. Change of the setting .....	15
5.3. List of parameters .....	16
6. Control .....	17
6.1. ON-OFF control .....	17
6.2. PID control .....	17
6.2.1. Choice of PID settings by the method of object identifying .....	18
6.2.2. Choice of PID settings by the oscillation method .....	19
6.2.3. Correction of PID settings .....	19
7. Error signalling .....	20
8. Technical data .....	21
9. Execution and ordering codes .....	23
10. Maintenance and guarantee .....	24



## 1. APPLICATION

The RE21 controller is destined to control temperature in furnaces, dryers, injection moulding machines and others.

It co-operates directly with temperature sensors of resistance thermometer or thermocouple types. For thermocouples the temperature of cold ends is automatically compensated.

The controller has a relay output with a shorted-opened configuration enabling the direct control of not big power objects.

## 2. CONTROLLER SET

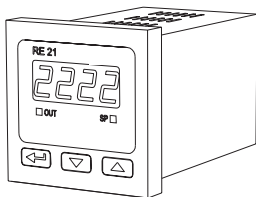

controller - 1 pc

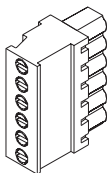

plug - 1 pc

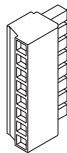

plug - 1 pc

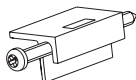

holder to fix in  
the panel - 2 pcs

user's manual - 1pc

guarantee card - 1pc

quick start card - 1pc

When unpacking the instrument, please check whether the type and execution code on the data plate correspond to the order.

## 3. PREPARATION OF THE CONTROLLER TO WORK

### 3.1. Safety

The RE21 controller fulfils requirements concerning the electrical safety of measuring instruments in automation acc. to EN 61010-1, and requirements concerning immunity against electromagnetic interference acc. to EN 61000-6-2 and emission of electromagnetic interference occurring in industrial environment acc. to EN 61000-6-4

### BASIC REQUIREMENTS, SAFETY INFORMATION

Symbols located in this service manual mean:

#### **WARNING!**



Warning of potential, hazardous situations. Especially important. One must acquaint with this before connecting the instrument. The non-observance of notices marked by these symbols can occasion severe injuries of the personnel and the damage of the instrument.

#### **CAUTION!**



Designates a general useful note. If you observe it, handling of the meter is made easier. One must take note of this, when the instrument is working inconsistently to the expectations. Possible consequences if disregarded !

**In the security scope the meter meets the requirements of the EEC Low-Voltage Directive (EN 61010 -1 issued by CENELEC ).**

Remarks concerning the operator safety:

## 1. General

- The controller is destined to be mounted on a panel.
- Non-authorized removal of the required housing, inappropriate use, incorrect installation or operation creates the risk of injury to personnel or damage to equipment. For more detailed information please study the User's Manual.
- All operations concerning transport, installation, and commissioning as well as maintenance must be carried out by qualified, skilled personnel and national regulations for the prevention of accidents must be observed.
- According to this basic safety information, qualified, skilled personnel are persons who are familiar with the installation, assembly, commissioning, and operation of the product and who have qualifications necessary for their occupation.

## 2. Transport, storage

Please observe the notes on transport, storage and appropriate handling.

Observe the climatic conditions given in Technical Data.

## 3. Installation

- The controller must be installed according to the regulation and instructions given in this User's Manual.
- Ensure proper handling and avoid mechanical stress.
- Do not bend any components and do not change any insulation distances.
- Do not touch any electronic components and contacts.
- Controllers may contain electrostatically sensitive components, which can easily be damaged by inappropriate handling.
- **Do not damage or destroy any electrical components since this might endanger your health!**

#### **4. Electrical connection**

- Before switching the controller on, one must check the correctness of connection to the network.
- In case of the protection terminal connection with a separate lead one must remember to connect it before the connection of the controller to the mains.
- When working on live controllers, the applicable national regulations for the prevention of accidents must be observed.
- The electrical installation must be carried out according to the appropriate regulations (cable cross-sections, fuses, PE connection). Additional information can be obtained from the user's manual.
- The documentation contains information about installation in compliance with EMC (shielding, grounding, filters and cables). These notes must be observed for all CE-marked products.
- The manufacturer of the measuring system or installed devices is responsible for the compliance with the required limit values demanded by the EMC legislation.

#### **5. Operation**

- Measuring systems including RE21 controllers, must be equipped with protection devices according to the corresponding standard and regulations for prevention of accidents.
- After the controller has been disconnected from the supply voltage, live components and power connections must not be touched immediately because capacitors can be charged.
- The housing must be closed during operation.

#### **6. Maintenance and servicing.**

- Please observe the manufacturer's documentation.
- Read all product-specific safety and application notes in this User's Manual.
- Before taking the meter housing out, one must turn the supply off.
- The removal of the instrument housing during the guarantee contract period may cause its cancellation.



### 3.2. Controller installation

The controller is fixed to the panel by two screw holders included in the standard accessory set, acc. to the fig. 1. The panel hole should be  $45^{+0.6} \times 45^{+0.6}$  mm.

The thickness of the material which the panel is made of, cannot exceed 15 mm.

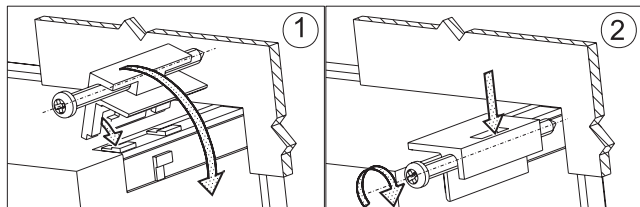

**Fig.1. Controller fixing.**

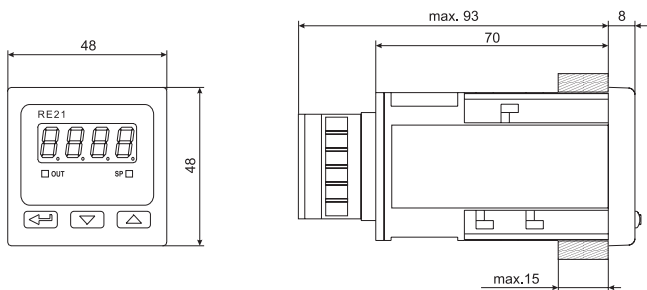
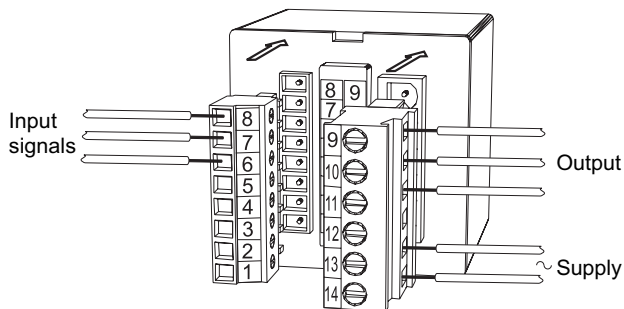

**Fig. 2. Overall dimensions of the controller.**

### 3.3. Electrical connections

Electrical connections should be executed in compliance with fig. 3 and fig. 4. .

Make electrical connections to the terminal strips and next, force in the strips into controller sockets.



**Fig. 3. Description of the controller terminal strips.**

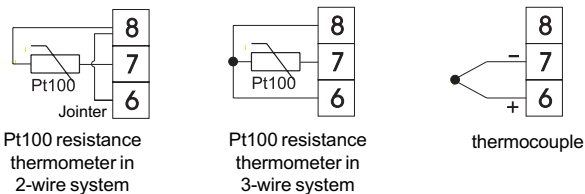

**Fig.4. Connection of input signals.**

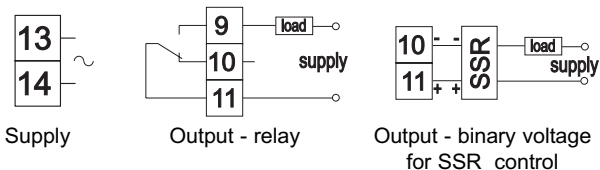

**Fig.5. Connection of the main and load circuits.**

### 3.4. Installation recommendations

To obtain a full immunity of the controller against electromagnetic interference in an unknown environment interference level it is recommended to observe following principles:

- do not supply the controller from the network near devices generating high pulse interference and do not use common earthing circuits with them.
- apply network filters,
- apply metallic shields in the shape of tubes or braided screens to conduct supplying wires,
- wires supplying the measuring signal should be twisted in pairs, and for resistance thermometers in a 3-wire connection, twisted from wires with the same length, cross-section and resistance, and led in a shield as above,





- all shields should be one-side earthed, and led the nearest possible to the controller,
- apply the general principle that wires leading different signals should be led the farthest possible between them (not less than 30 cm), and the crossing executed of these groups of wires must be made at right angle.

## 4. STARTING TO WORK

After the correct installation and supply connection, the controller carries out the display test and displays the type of controller **RE21**, the program version and next, the measured value. A character message can appear on the display informing about abnormalities (table 2).

The ON-OFF control algorithm with hysteresis = 2°C is set by the manufacturer.

### Change of the set value

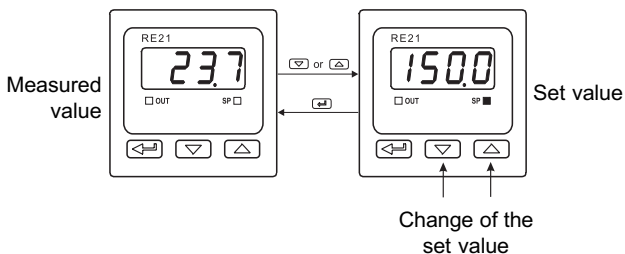

The set value is displayed after pressing the  or  key. The way to change the set value is shown on the fig.6. The return to display the measured value follows after pressing the  key or after 30 seconds from the last pressure of the  or  key.





**Fig.6. Change of the set value.**

## 5. PROGRAMMING OF CONTROLLER PARAMETERS

### 5.1. Scheme of the controller menu

The controller menu scheme is presented on the fig.7. After pressing and holding during at least 2 seconds the  key, it is possible to program parameters. Transition between parameters is carried on by means of  and  keys.





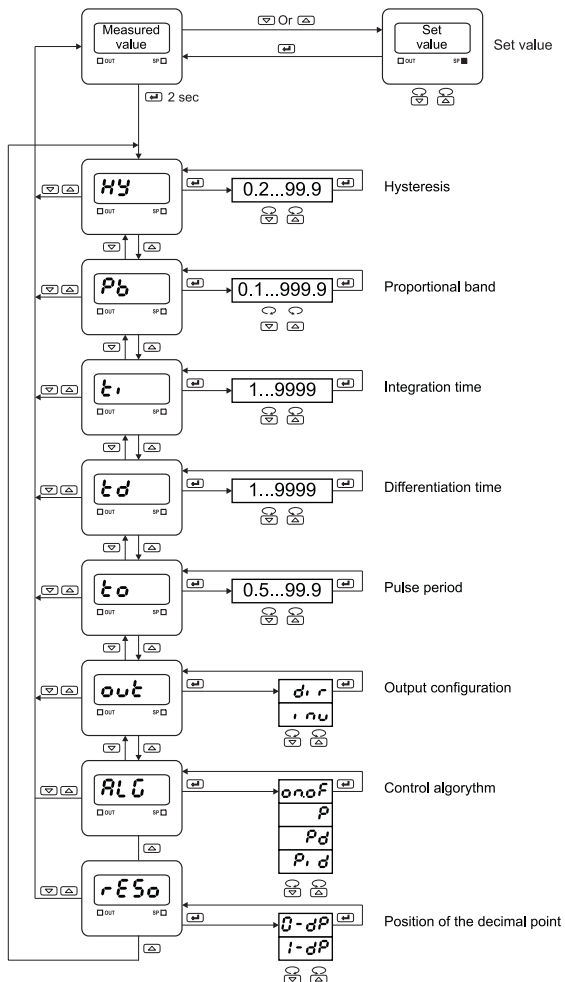

Some parameters can be invisible - this depends on the control algorithm selection.

The return to the normal working mode follows after the simultaneous pressure of  and  keys or automatically after the laps of 30 seconds since the last key pressure.

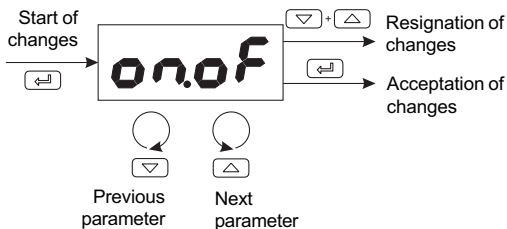
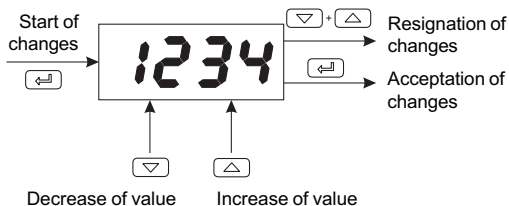

**Fig.7. Servicing menu of the controller.**

## 5.2. Change of setting

The parameter setting change begins after the pressure of the  key. The selection of the setting is carried out by  and  keys and accepted by the  key. The change cancellation is carried out by a simultaneous pressure of  and  keys or automatically after 30 sec from the last key pressure.

The way of the setting change is shown on the fig. 8.



**Fig.8. Change of settings for numerical and textual paramete.**

### 5.3. List of parameters

The list of controller parameters is presented in the table 1.

List of configuration parameters

Table 1

Parameter symbol	Parameter description	Manufacturer setting	Range of parameter change
<i>HY</i>	Hysteresis <sup>1)</sup>	2.0	0.2...99.9 °C
<i>Pb</i>	Proportional band <sup>2)</sup>	30.0	0.1...999.9 °C
<i>t<sub>i</sub></i>	Integration time-constant <sup>3)</sup>	300	1...9999 s
<i>t<sub>d</sub></i>	Differentiation time-constant <sup>4)</sup>	60	1...9999 s
<i>t<sub>o</sub></i>	Pulse period <sup>2)</sup>	20.0	0.5...99.9 s
<i>out</i>	Output configuration	<i>on</i>	<i>d</i> : direct control (cooling) <i>n</i> : reverse control (heating)
<i>ALG</i>	Control algorithm	<i>onof</i>	<i>onof</i> : control algorithm ON-OFF <i>P</i> : control algorithm P <i>Pd</i> : control algorithm PD <i>P, d</i> : control algorithm PID
<i>res0</i>	Position of the decimal point	<i>1-dP</i>	<i>0-dP</i> : without decimal point <i>1-dP</i> : 1 decimal point

<sup>1)</sup> The parameter is visible only for ON-OFF algorithm.

<sup>2)</sup> The parameter is visible only for P, PD or PID algorithm.

<sup>3)</sup> The parameter is visible only for the PID algorithm.

<sup>4)</sup> The parameter is only visible for PD or PID algorithm.



## 6. CONTROL

### 6.1. ON-OFF control

When a high accuracy of the temperature control is not required, especially with a great time-constant and a small delay, one can use the ON-OFF control with hysteresis. Advantages of this way of control is simplicity and reliability. However, the disadvantage is the occurrence of oscillations, even at small hysteresis values.

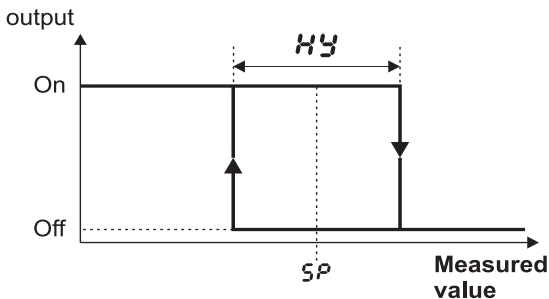
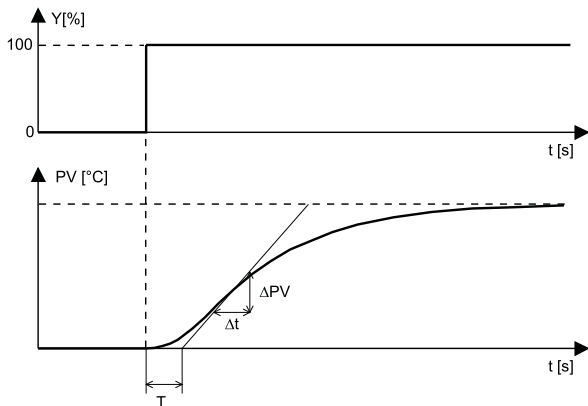

*Fig.9. Way of the output action of heating type for ON-OFF control.*

### 6.2. PID control

When we want to obtain a better temperature control accuracy, one must take advantages of the PID algorithm. The adjustment of the controller to the object relies on the value settlement of the integrating element, differentiating element and the output pulse period.

## 6.2.1. Choice of the PID settings by the method of the object identifying



One must read out the delay time of the  $T_0$  object from the object characteristic presenting the controlled quantity in the function of time and the maximal accretion speed of the temperature from the dependence:

$$V_{max} = \frac{\Delta PV_{max}}{\Delta t}$$

Calculate PID settings acc. to the given formulas:

$Pb = 1.1 \cdot V_{max} \cdot T_0$  - proportional band

$t_i = 2.4 \cdot T_0$  - integration time-constant

$t_d = 0.4 \cdot T_0$  - differentiation time-constant

## 6.2.2. Choice of PID settings by the oscillation method

Set the ON-OFF control with the minimal hysteresis.

Set the set value on the normal work level (or on lower level, if over-regulations could cause damages) and normal load conditions.

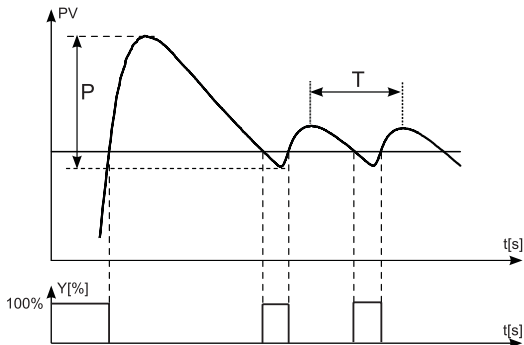

**Fig.10. Choice of settings by the oscillation method**

Calculate controller settings acc. to the given formulas:

$$P_b = P$$

$$t_j = T$$

$$t_d = 0.25 \cdot T$$

## 6.2.3. Correction of PID settings

It is recommended to match the parameters, changing the value into a twice higher or twice lower. During changes, one must be guided by following principles:

a) Free answer of the jump:

- decrease the proportional band,
- decrease integration and differentiation times.

- b) Over-regulations:
- increase the proportional band,
  - increase the differentiation time.
- c) Oscillations:
- increase the proportional band,
  - increase the integration time,
  - decrease the differentiation time.
- d) Instability:
- increase the integration time.

## 7. ERROR SIGNALLING

Character messages signaling the incorrect controller operation.

Table 2

Error code (upper display)	Cause	Procedure
<b>LERR</b>	Exceeding of the measuring range downward or lack of thermistor.	Check if the chosen type of sensor is conform to the switched on. Check if values of input signals are contained in the appropriate range - if yes, check if a short-circuit does not occur in the resistance thermometer or if the thermocouple has not been inversely switched on.
<b>HERR</b>	Exceeding of the measuring range upward or break in the sensor circuit.	Check if the chosen type of sensor is conform with the switched on. Check if values of input signals are contained in the appropriate range - if yes, check if there is no break in the sensor circuit.
<b>ERRd</b>	Input discalibrated.	Switch on again the controller supply and if this cannot help, contact the nearest authorized workshop.

## 8. TECHNICAL DATA

**Input signal** acc. to the table 3

Input signals and measuring ranges for inputs

Table 3

Sensor/input type	Marking	Range [°C]	Basic error [°C]
<b>Pt100</b> acc. to EN 60751+A2	Pt100	-50...100	0.8
<b>Pt100</b>	Pt100	0...250	1.3
<b>Pt100</b>	Pt100	0..600	3.0
<b>Fe-CuNi</b> acc. to EN 60584-1	J	0...250	3.0
<b>Fe-CuNi</b>	J	0...600	4.0
<b>Fe-CuNi</b>	J	0...900	5.0
<b>NiCr-NiAl</b> acc. to EN 60584-1	K	0...600	4.0
<b>NiCr-NiAl</b>	K	0...900	5.0
<b>NiCr-NiAl</b>	K	0...1300	6.0
<b>PtRh10-Pt</b> acc. to EN 60584-1	S	0...1600	7.0

**Measurement time** 0.5 s

**Error detection in the measuring circuit:**

- thermocouple, Pt100 exceeding of the measuring range

**Kind of output:**

- relay switching contact maximal load capacity:  
voltage: 250 V a.c., 150 V d.c.  
current: 5 A, 250 V a.c., 5 A, 30 V d.c.  
resistance load: 1250 VA, 150 W

- binary voltage (without insulation from the sensor side) voltage 6 V +0.3 V, resistance limiting the current: 100 Ω

**Way of output action:**

- reverse for heating  
- direct for cooling

**Signalling of:**

- active output
- set value display

**Rated service conditions:**

- supply voltage 230 V a.c.  $\pm 10\%$   
110 V a.c.  $\pm 10\%$   
24 V a.c.  $\pm 10\%$
- supply voltage frequency 50/60 Hz
- ambient temperature 0...23...50 °C
- storage temperature -20...+70 °C
- relative humidity < 85 % (inadmissible condensation)
- external magnetic field < 400 A/m
- preheating time 30 min
- work position any

**Power consumption**

&lt; 3 VA

**Weight**

&lt; 0.25 kg

**IP protection ensured through the housing acc. EN 60529**

- from the frontal side IP40
- from terminals IP20

**Additional errors in rated working conditions caused by:**

- ambient temperature changes  $\leq 100\%$  of the basic error /10 K.

**Security requirements acc to EN 61010-1**

- installation category - III,
- pollution degree - 2,
- maximal phase-to-earth work voltage:
  - for the supply circuit, outputs - 300 V
  - for input circuits - 50 V

**Electromagnetic compatibility**

- immunity acc. EN 61000-6-2
- emission acc. EN 61000-6-4

## 9. ORDERING CODES

The coding way is given in the table 4

Table 4

Temperature controller RE21 -	XX	X	XX	X
<b>Input</b>				
resist. thermometer Pt100 (-50...100°C) .....	01			
resist. thermometer Pt100 (0...250°C) .....	02			
resist. thermometer Pt100 (0...600°C) .....	03			
thermocouple Fe-CuNi (0...250°C) .....	04			
thermocouple Fe-CuNi (0...600°C) .....	05			
thermocouple Fe-CuNi (0...900°C) .....	06			
thermocouple NiCr-NiAl (0...600°C) .....	07			
thermocouple NiCr-NiAl (0...900°C) .....	08			
thermocouple NiCr-NiAl (0...1300°C) .....	09			
thermocouple PtRh10-Pt (0...1600°C) .....	10			
as ordered* .....	X			
<b>Supply voltage:</b>				
230 V 50/60 Hz .....		1		
110 V 50/60 Hz .....		2		
24 V 50/60 Hz .....		3		
as ordered* .....		X		
<b>Output:</b>				
relay .....			00	
binary 0/6 V for SSR control .....			01	
without output .....			09	
as ordered* .....			XX	
<b>Extra acceptance tests:</b>				
without extra quality requirements .....				0
with an extra quality inspection certificate .....				1
acc. agreement with the manufacturer** .....				X

\* The code numbering is defined by the manufacturer

\*\* After agreement with the manufacturer

Example of ordering:

Code **RE21 - 03 - 2 - 00 - 0** means:

- 03** - Pt100 resistance thermometer as the input
- 2** - supply = 110 V, 50/60 Hz
- 00** - relay output
- 0** - without extra quality requirements

## 10. MAINTENANCE AND WARRANTY

The RE21 controller does not require any periodical maintenance.

In case of some incorrect operations:

### **1. After the dispatch date and within the period stated in the warranty card**

One should return the instrument to the Manufacturer's Quality Inspection Dept. If the instrument has been used in compliance with the instructions, the Manufacturer guarantees to repair it free of charge. The disassembling of the housing causes the cancellation of the granted warranty.

### **2. After the warranty period**

One should send the instrument to repair it in a authorized service workshop.

Spare parts are available for the period of five years from the date of purchase.

<p>The Manufacturer reserves the right to make changes in design and specifications of any products as engineering advances or necessity requires.</p>
--





LUMEL S.A.RE21/January 2006



Lubuskie Zakłady Aparatów Elektrycznych - LUMEL S.A.  
ul. Sulechowska 1, 65-022 Zielona Góra, Poland

Tel.: (48-68) 32 95 100 (exchange)

Fax: (48-68) 32 95 101

[www.lumel.com.pl](http://www.lumel.com.pl)

e-mail:[lumel@lumel.com.pl](mailto:lumel@lumel.com.pl)

Export Department:

Tel.: (48-68) 329 53 02 or (48-68) 329 53 04

Fax: (48-68) 325 40 91

e-mail: [export@lumel.com.pl](mailto:export@lumel.com.pl)