

LUMEL

**PROGRAMMABLE TRANSDUCER
WITH RS-485 INTERFACE
(temperature, standard signals,
d.c. voltage, d.c.current)**

P12U



45 × 120 × 100 mm

USER'S MANUAL

CE

CONTENTS

PAGE

1. APPLICATION.....	3
2. SET OF THE P12U TRANSDUCER	4
3. BASIC REQUIREMENTS, OPERATIONAL SAFETY	5
4. INSTALLATION	5
4.1 Fitting of the P12U transducer	5
4.2 External connection diagrams	6
5. SERVICING.....	9
6. RS-485 INTERFACE.....	27
7. TECHNICAL DATA.....	45
8. BEFORE A DAMAGE WILL BE SUBMITTED	48
9. EXAMPLES OF P12U TRANSDUCER PROGRAMMINGS.....	51
10. EXECUTION CODES AND ORDERING.....	53
11. MAINTENANCE AND GUARANTEE	56

1. APPLICATION

The P12U programmable transducer is intended to the conversion of temperature, resistance, voltage from the shunt, standard signals, d.c. voltage and d.c. current into a d.c. standard signal or d.c. voltage standard signal. The output signal is galvanically isolated from the input signal and the supply. The read-out field can be an LCD 2 x 8 display (only in the P12U-2 execution).

The P12U transducer is programmed by the producer according the ordered execution code but it is possible to change the parameters by means of the keyboard in the P12U-2 execution, through RS-485 or through the PD14 programmer. The PD14 programmer¹⁾ is a universal device serving to program all the P11 and P12 transducer family.

FEATURES

P12U transducers realize following functions:

- conversion of the measured value into any optional output signal on the base of the individual linear characteristic,
- re-count of the input signal into the indication on the base of the multi-segment individual characteristic (maximum: 20 segments),
- signalling of the set up alarm value overrunnings,
- recording of the input signal in programmed time periods,
- arithmetical: raising to a power, extraction of roots, or result inverse,
- programming of the indication resolution (only in P12U-2),
- preview of set up parameter values,
- switching the automatic compensation on or off. Possible introduction of a manual correction,
- storage of maximal and minimal values,
- programming of the measurement averaging time,
- display of the unit according the table 1,
- servicing of the RS-485 interface in the MODBUS protocol, both in ASCII either in RTU mode,
- deadlock of the parameter introduction by means of a password.

¹⁾ **Note:** One must ordered the PD14 programmer separately

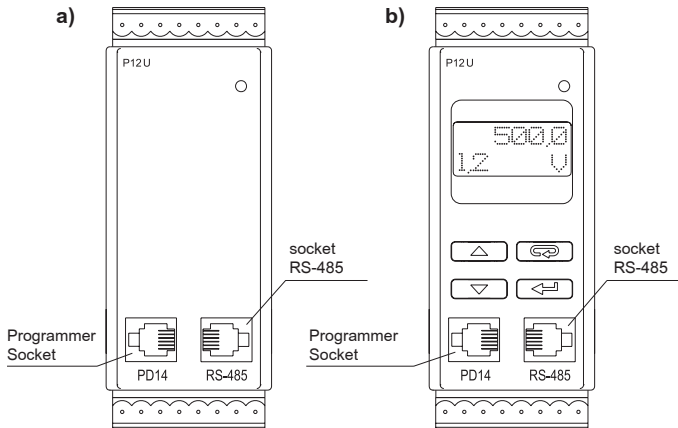

Fig.1 View of the P12U transducer: a) P12U-1, b) P12U-2

2.SET OF THE P12U TRANSDUCER

The set is composed of:

- P12U transducer 1 pc
- Service manual 1 pc
- Guarantee card 1 pc
- Plug with screw terminals
or self-locking terminals 4 pcs
- Hole plug of the programmer socket 2 pcs

When unpacking the transducer, please check whether the type and execution code on the data plate correspond to the order code.

3. BASIC REQUIREMENTS, OPERATIONAL SAFETY

Symbols located in this service manual mean:



Especially important, one must acquaint with this before connecting the transducer. The non-observance of notices marked by these symbols can occasion the damage of the transducer.



One must take note of this when the transducer is working inconsistently to the expectations.



Remarks concerning the operator safety:

- P12U transducers are destined to be mounted on 35 mm DIN rails. In the range of operational safety they are in conformity with the EN 61010-1 standard requirements,
- the installation and transducer connection should be operated by a qualified personnel,
- one must take into consideration all accessible protection requirements,
- before switching the instrument on, one must check the correctness of the network lead connection,
- in case of the protection terminal connection with a separate lead one must remember to connect it before the connection of network leads,
- do not connect the instrument to the network through an auto-transformer,
- before taking the transducer housing out, one must turn the supply off,
- the removal of the transducer housing during the warranty contract period may cause its cancellation,
- the **programmer socket** serves only to connect the PD14 or PD11 programmer,
- the **RS-485 socket** serves only to connect devices working with the MODBUS protocol,
- place hole plugs into the unused transducer sockets (of the programmer and RS-485).

4. INSTALLATION

4.1. Fitting of the P12U transducer

P12U transducers are designed to be installed on a 35 mm DIN rail acc. DIN EN 50 022. On the external side of the transducer, there are screw or self-locking terminal strips enabling the connection of 2.5 mm² cross-section conductors. The housing is made of a self-extinguishing thermoplastics. Overall dimensions of the

housing: 45 x 120 x 100 mm.

Overall dimensions and the fixing way are shown on the fig.2.

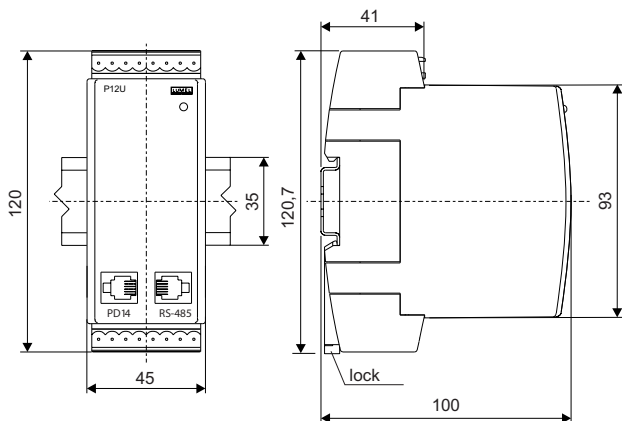

Fig.2. Overall dimensions and fixing way of P12U transducers

4.2. External connection diagrams



Electrical connections must be executed according Fig. 3.

Taking into consideration electromagnetic interference, it is recommended to use screened conductors to connect input or output signals.

The supply must be connected through a two-wire conductor of appropriate diameter ensuring its safety by means of an installation fuse.

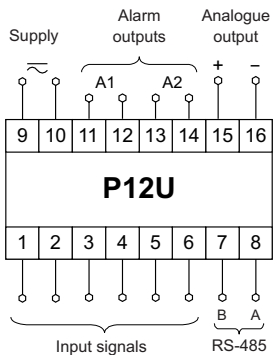

a) Connection way of input signals

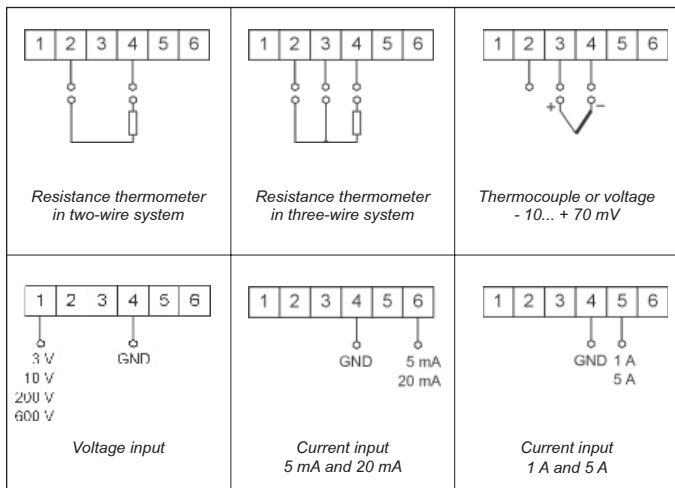

b) Connection way of the RS-485 interface

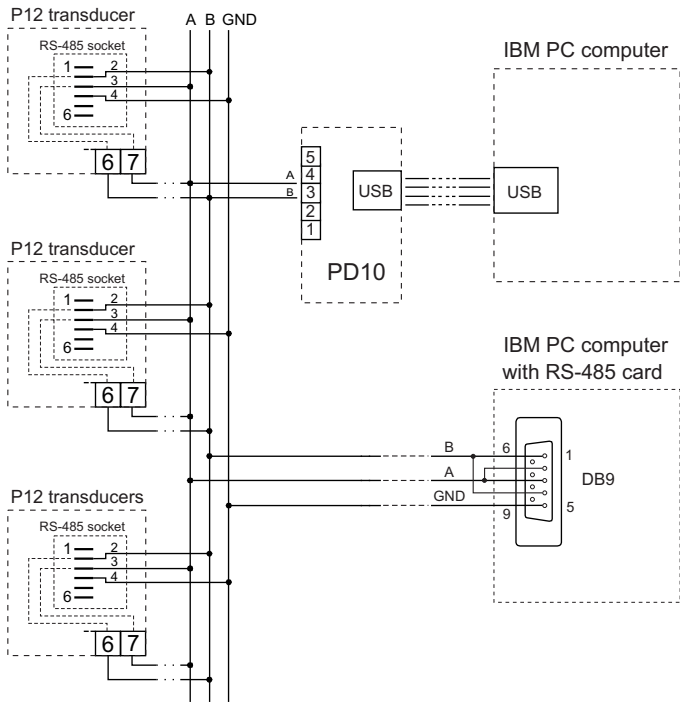
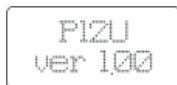

Fig. 3. External connections of the P12U transducer

5. SERVICING

After connecting external signals and turning the supply on, what is signalled by a lighted diode, the transducer displays the type and the current version of the program.



After ca 3s, the transducer automatically transits into the working mode, in which it executes the measurement and conversion into an analogue output signal. It displays the measured value, the unit of the measured or set value by the user and marks of connected alarms.

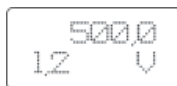

The transducer automatically blanks void zeros. The recording switching on is signalled on the display (the mark „M” means the recording switching on, the mark „E” means an empty (blank) memory, however the mark „F” means a full memory). After filling the memory, the transducer automatically switches the recording off.

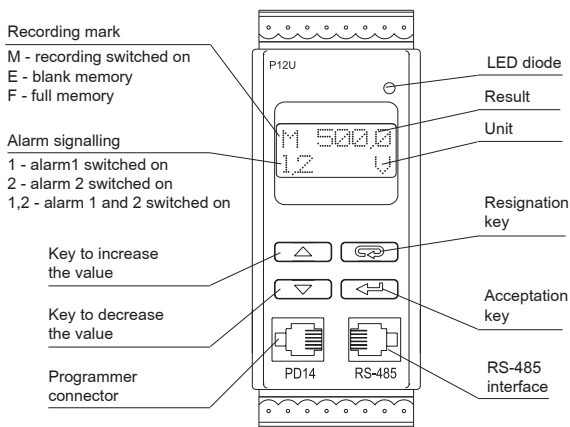

Fig. 4. Description of the P12U transducer frontal plate.

Key functions:



- acceptance key

- entry into the programming mode (hold down ca 3 s),
- entry into the change of the parameter value mode,
- acceptance of the modified parameter value.



- key to increase the value

- display of the maximal value,
- moving along the preview menu or on the programming matrix,
- modification of the chosen parameter value - value increasing.





- key to decrease the value



- display of the minimal value,
- moving along the preview menu or on the programming matrix,
- modification of the chosen parameter value - value decreasing.



- key for the value resignation

- entry into the menu of parameter preview (hold down ca 3 s),
- exit from the preview menu or programming matrix.
- resignation of the parameter change.



The pressure of  and  keys and holding down within ca 3 s causes the erasing of the alarm signalling and/or alarm outputs. This operation works exclusively when the support function is switched on.

The pressure of  and  keys causes the erasing of the minimal value.

The pressure of  and  keys causes the erasing of the maximal value.

The pressure and holding down of the  key within ca 3 s causes the entry into the programming mode. The programming mode is secured by a security code.



The pressure and holding down of the  key within ca 3 s cause the entry into the preview menu. One must move on the preview menu by means of  and  keys. In this menu, all transducer programmable parameters are accessible only for readout, with the exception of servicing parameters.

The exit from the preview menu is carried out by means of the  key. It is possible to review recorded values in the preview menu.

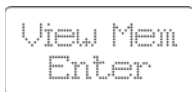

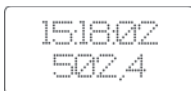

View Mem
Enter

The pressure of  key causes the entry into the review menu of recorded value



15:18:02
502,4

The upper line informs about the sample recording time. However the value of the recorded sample is shown on the lower line. The moving on the recorded values follows after pressing the  and  keys.

The holding down of one of these keys for a laps of time longer than 2 s will cause the acceleration of the reviewing. The pressure of the  key causes the **Pos/Size** display inscription and the appearance of the sample number, and the full quantity of the occupied memory.

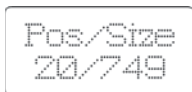

Pos/Size
20/749

The exit from the review of recorded values is carried out by means of the  key.

The algorithm of the transducer servicing is shown on the Fig.5.p

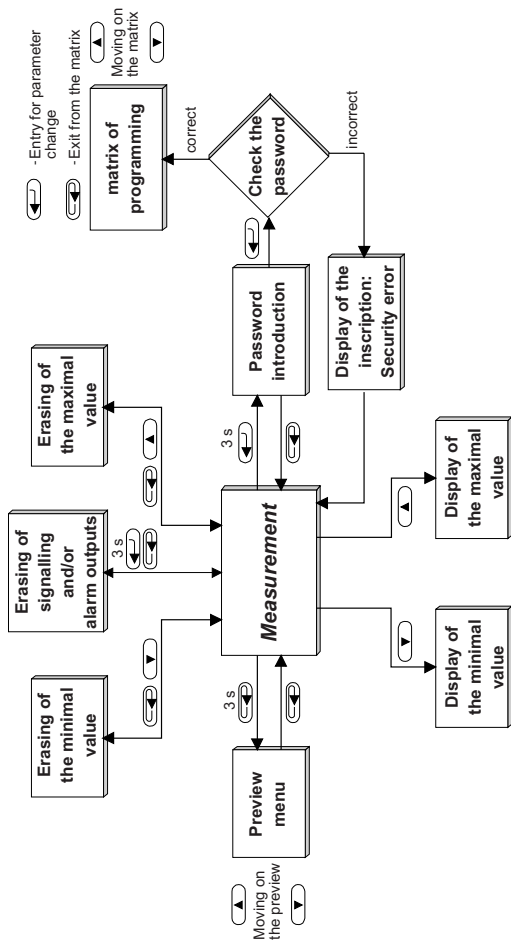
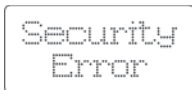

Fig. 5. Algorithm of the P12U transducer servicing.

The appearance of mentioned below symbols and inscriptions means:



Security
Error

Incorrectly introduced security code.



Over. Hi
12 V

Overrunning of the lower measuring range or lack of sensor.



Over. Lo
12 V

Overrunning of the lower measuring range or sensor short-circuited.



Err. Comp
12 V

Error of the conductor resistance compensation.
No connected or damaged conductor.

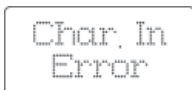

Char. In
Error

Incorrect introduction of individual characteristic parameters. In this case, the switching of the individual characteristic off follows. One must introduce input parameters in an ascending way: $X_n I_n < X_{n+1} I_n$

The change of transducer parameters is possible:

- from the transducer keyboard (in P12U-2) - p 5.1.
- through the PD14 programmer and a PC computer - p 5.2.
- through RS-485 - p 6.5.

5.1. Change of P12U transducer parameters from the keyboard

The pressure of the  key within ca 3 s causes the display of the inscription:

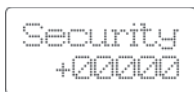

Security
+00000

The writing of the correct code in causes the entry into the programming mode.
 The designs below present the way of programming:

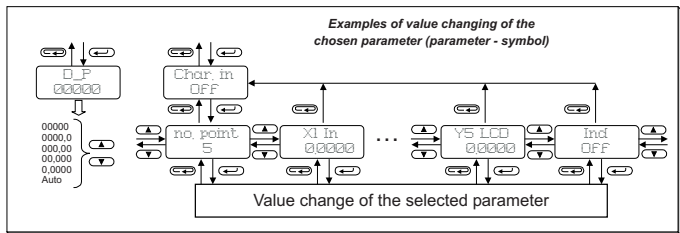
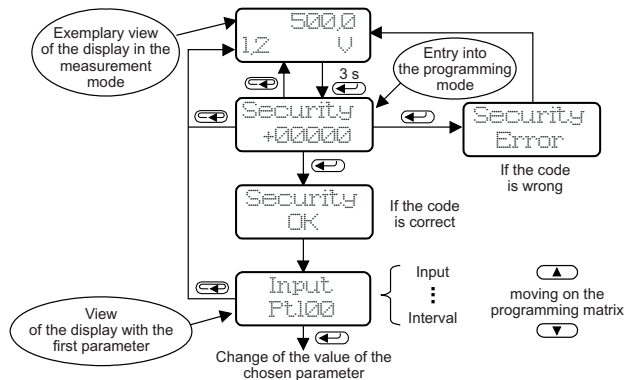

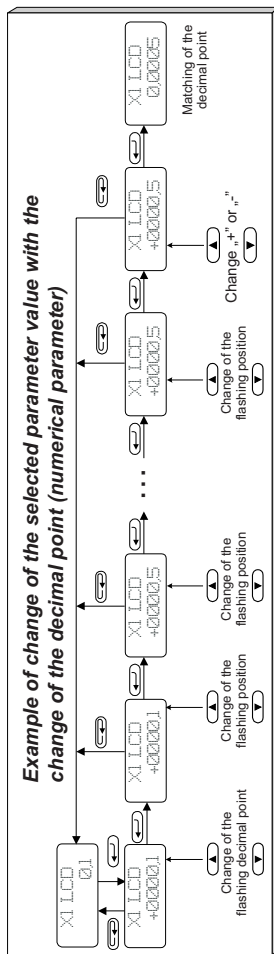
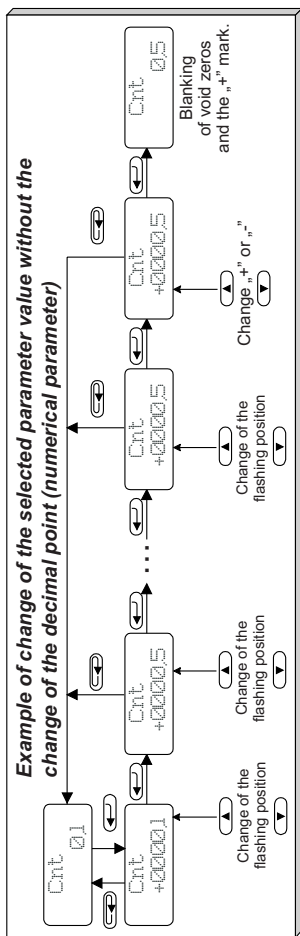

Fig. 6. Transition matrix in the programming mode

5.2. Change of P12U transducer parameters through the PD14 programmer

The way of connection of the P12U transducer through the PD14 programmer to the PC computer is shown on the Fig. 7. The programmer is connected from one side to the USB port of the PC computer, and from the second side, through a plug of RJ12 type to the P12U transducer.

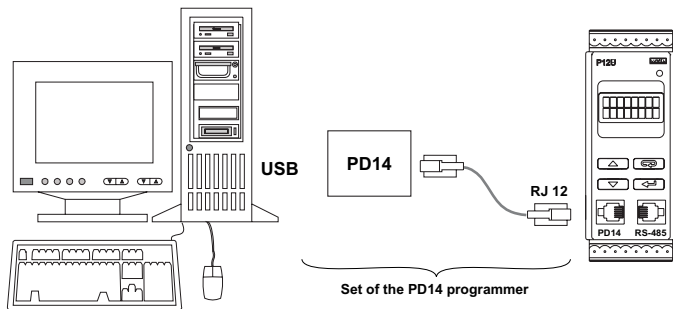



Fig. 7. Connection way of the P12U transducer through the PD14 programmer to the PC computer

Programmable transducer parameters are presented in the table 1. The programming of parameters is possible after the previous introducing of the password.

	<i>Symbol on the display</i>	<i>Description of parameters</i>	<i>Range of changes</i>
<i>Input parameters</i>		Input type	Resistance thermometers: Pt100 Pt500 Pt1000 Cu100 Ni100 Thermocouples: Therm. J - (Fe-CuNi) Therm. K - (NiCr-NiAl) Therm. N - (NiCrSi-NiSi) Therm. E - (NiCr-CuNi) Therm. R - (PtRh13-Pt) Therm. S - (PtRh10-Pt) Therm. T - (Cu-CuNi) 400 Ω 4 kΩ 70 mV Standard signals: 3 V 10 V 5 mA 20 mA High signals: 200 V 600 V 1 A 5 A
		Mathematical functions: The conversion of the result through mathematical functions follows before the individual characteristic	Off - mathematical functions switched off Sqr - raising to a power (result) ² Sqrt - extraction of roots $\sqrt{\text{result}}$ Exp - result inverse $\frac{1}{\text{result}}$





	Symbol on the display	Description of parameters	Range of changes
Input parameters (continuation)		<p>Kind of compensation of sensor working conditions changes:</p> <ol style="list-style-type: none"> in case of a resistance thermometer and resistance measurement, concerns the compensation of the resistance change of conductors connecting the sensor with the transducer, in case of a thermocouple, concerns the compensation of reference cold junction temperature changes. <p>The automatic compensation does not operate in case of the resistance measurement up to 4 kΩ, Pt1000 and Pt500.</p>	<p>Auto - The automatic compensation (in case of resistance thermometers and resistance measurements requires a three-wire line).</p> <p>0...60°C - value of the reference cold junction temperature for thermocouples.</p> <p>0...40 Ω - resistance of two wires for resistance thermometers and resistance measurement.</p> <p>The accuracy of data introduction: $\pm 0.1\%$</p> <p>The written in values beyond the interval of the manual compensation range will cause the switching of the automatic compensation on.</p>
		<p>Setting of the decimal point.</p> <p>The setting operates either when the individual characteristic is switched off or on.</p> <p>The introduction of the decimal point which makes impossible the display of 7 characters („+ or -“, 5 characters for the result, the decimal character) on the display will cause the display of the low or upper exceeding.</p>	<p>Possibility of settings:</p> <p>00000</p> <p>0000.0</p> <p>000.00</p> <p>00.000</p> <p>0.0000</p> <p>Auto - automatic choice of the decimal point</p>
		<p>Averaging time of the measurement</p>	<p>0...9999.9 s</p> <p>The writing of the 0 causes the measurement switching off and the stoppage of the transducer work. The current time is displayed on the display.</p>
		<p>Selection of the unit</p>	<p>Possibility of settings:</p> <p>V, A, μV, mV, kV, MV, μA, mA, kA, MA, mW, W, kW, MW, var, kvar, Mvar, VA, kVA, MVA, °C, °F, K, Hz, kHz, MHz, mAh, Ah, kAh, Wh, kWh, MWh, m/s, μm, mm, cm, m, km, m^2, m^3, m^2/s,</p>

Table 1 (continuation)

Input parameters (continuation)			m ² /min, m ² /h, m ³ /s, m ³ /min, m ³ /h, l, l/s, l/min, l/h, l/m ² , l/m ³ , kg/s, kg/min, kg/h, ms, s, h, mN, N, kN, Pa, hPa, kPa, MPa, mmHg, bar, rad, mΩ, Ω, kΩ, MΩ, GΩ, %, °, turns, rps, rpm, rph, m/h, km/h.					
	Char. In On	no.point 3	Number of points of the individual characteristic	Possible settings: 2... 21				
	X1 In 0,0000	Y1 In 0,0000	X2 In 5,0000	Y2 In 100,00	X3 In 10,000	Y3 In 50,000	<p>Parameters of input individual characteristic. On the base of given co-ordinates of points by the user, the transducer assigns (from the system of equations) coefficients a and b of the individual characteristic</p> $\begin{cases} Y_n LCD = a \cdot X_n In + b \\ Y_{n+1} LCD = a \cdot X_{n+1} In + b \end{cases}$ <p>$X_n In$ - measured value $Y_n LCD$ - expected value on the display. The Fig. 9 shows the operation way of the individual characteristic.</p>	<p>Possible settings: - 99999... 99999 One must write in the input parameters in an ascending way ($X_n In < X_{n+1} In$) The correct writing of individual characteristic parameters causes the display of the inscription:</p> <p style="text-align: center;">Char. In OK</p> <p>However, the incorrect writing of individual characteristic parameters causes the display of the inscription:</p> <p style="text-align: center;">Char. In Error</p> <p>and the switching of the individual characteristic off.</p>
	Char. In On		Switching off or on of the linear individual characteristic of the user - („ individual characteristic of the input “). Fig. 9a.	<p>On - characteristic switched on, Off - characteristic switched off.</p> <p>When the characteristic is switched off, the transducer operates with its maximal range depending on the kind of input.</p>				

Table 1 (continuation)







	Symbol on the display	Description of parameters	Range of changes
Alarm 1 and alarm 2 parameters	 	Alarming lower threshold	-99999...99999
	 	Alarming upper threshold	-99999...99999
	 	Type of alarm Fig.8. presents types of alarms.	Normal - normal, On - switched on, Off - switched off. Hand on - Switched on manually; up to the time of changing the alarm type the alarm output remains switched on for good. Hand off - Switched off manually; up to the time of changing the alarm type the alarm output remains switched off for good.
	 	Delay of alarm operation. The parameter is defined in seconds, ie one must give after how many seconds from its occurrence, the alarm operation will follow. The alarm operation occurs after the measurement averaging. The alarm switching-off follows without delay.	0.0...9999.9 The introduction of 0.0 causes the operation at the moment of the alarm occurrence.

Table 1 (continuation)

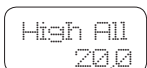
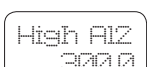

Alarm 1 and alarm 2 parameters (continuation)	<div style="border: 1px solid black; padding: 5px; margin-bottom: 5px; text-align: center;">Hold A11 OFF</div> <div style="border: 1px solid black; padding: 5px; margin-bottom: 5px; text-align: center;">Hold A12 Relay</div>	<p>The maintenance of the alarm signalling. In the situation when the maintenance function is switched on after the withdrawal of the alarm state on the display and/or the contact state does not change. It signals the alarm state till the moment of its termination by means of the key  and  during ca 3 s.</p>	<p>Off - Maintenance switched off, LCD - Maintenance of the alarm signalling on the display, Relay - maintenance of the alarm relay, LCD+Rel - maintenance of the signalling on the display and the</p>
Output parameters	<div style="border: 1px solid black; padding: 5px; margin-bottom: 5px; text-align: center;">Char Out OFF</div> <div style="border: 1px solid black; padding: 5px; margin-bottom: 5px; text-align: center;">X1 LCD 0,0</div> <div style="border: 1px solid black; padding: 5px; margin-bottom: 5px; text-align: center;">Y1 Out 0,0</div> <div style="border: 1px solid black; padding: 5px; margin-bottom: 5px; text-align: center;">X2 LCD 0,0</div> <div style="border: 1px solid black; padding: 5px; margin-bottom: 5px; text-align: center;">Y2 Out 0,0</div>	<p>The switching on or off of the individual linear user's characteristic - („the individual characteristic of the analogue output”). Fig. 9b.</p> <p>Parameters of the individual characteristic of the analogue output. On the base of given coordinates of two points by the user , the transducer determines (from the system of equations) the coefficients a and b of the individual characteristic.</p> $\begin{cases} Y1\ Out = a \cdot X1\ LCD + b \\ Y2\ Out = a \cdot X2\ LCD + b \end{cases}$ <p>Where: X1 LCD and X2 LCD - the displayed value, Y1 Out and Y2 Out - expected value on the analogue output. The fig. 9. presents the graphical illustration explaining the idea of the individual characteristic.</p>	<p>On - characteristic switched on, Off - characteristic switched off</p> <p>When the characteristic is switched off, the transducer operates with the maximal range</p> <p>Possibilities of settings: -99999...99999</p> <p style="text-align: center; font-size: 2em; color: gray; transform: rotate(-45deg); opacity: 0.5;">Accessible when the individual characteristic is switched on</p>

Table 1 (continuation)







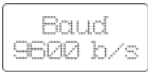

	<i>Symbol on the display</i>	<i>Description of parameters</i>	<i>Range of changes</i>
Output parameters (continuation)		Baude rate of the RS-485 interface	2400 b/s 4800 b/s 9600 b/s
		Kind of transmission through the RS-485 interface	Off - interface switched off ASCII 8N1 ASCII 7E1 ASCII 7O1 RTU 8N2 RTU 8E1 RTU 8O1 RTU 8N1
		Device address	0...247
Servicing parameters		Factory parameters. Factory parameters are presented in the table 2.	The pressure of the  key causes the registration of factory parameters.
		Introduction of a new password.	-99999...99999
		Display test. The display test consists on a successive lighting of the first line of LCD display segments, and next the whole line. The same test is carried out for the second line.	The pressure of the  key causes the test switching on. The pressure of the  key ends the test.
		Setting of the current time. Time format: hh:mm:ss	00:00:00 ... 23:59:00

Table 1 (continuation)

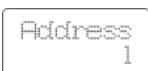
Recording parameters	<div style="border: 1px solid black; padding: 5px; text-align: center;">Memory OFF</div>	<p>Switching the recording on or off. At the moment of the recording switching on, the transducer erases the previous memorised values.</p> <div style="border: 1px solid black; padding: 5px; text-align: center; margin: 10px auto; width: fit-content;">Erasing Wait, . .</div>	<p>On - recording switched on Off - recording switched off</p>
	<div style="border: 1px solid black; padding: 5px; text-align: center;">StartMem 15:18:23</div>	<p>Time of the recording start. Time format: hh:mm:ss</p>	<p>00:00:00 ... 23:59:59</p>
	<div style="border: 1px solid black; padding: 5px; text-align: center;">DateMem 22:05:01</div>	<p>Date of the recording start. Date format: dd.mm.yy This is an information parameter. It does not serve to define the date from which the recording is to begin but only to inform when the recording was started.</p>	<p>00.00.00 ... 99.99.99</p>
	<div style="border: 1px solid black; padding: 5px; text-align: center;">Interval 01:00:00</div>	<p>Time interval of the recording. Define the time segment and how often the result is to be memorised.</p>	<p>00:00:00 ... 99:59:59</p>

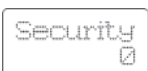
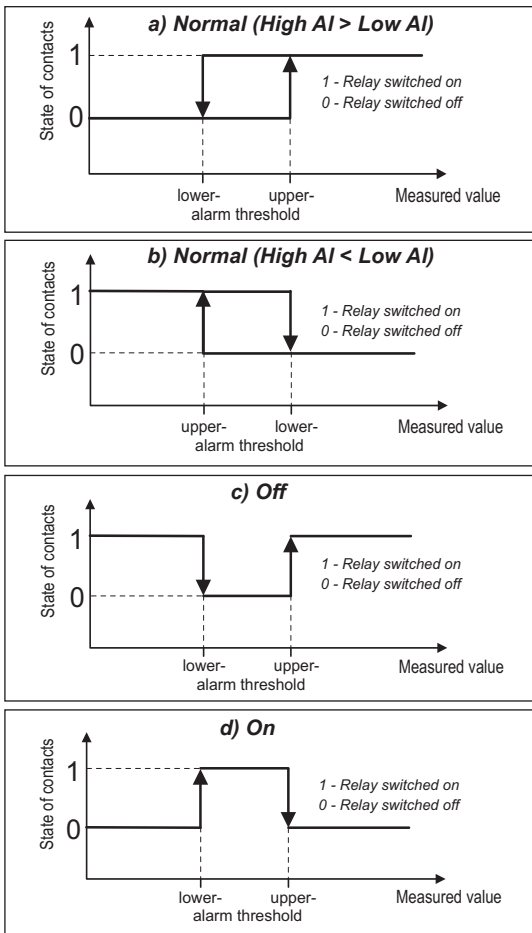
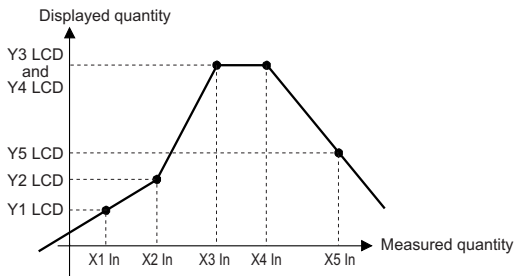

Fig. 8. Alarm types: a), b) normal c) switched off d) switched on.

a)



X1 In value on the transducer input => Y1 LCD value on the display

X5 In value on the transducer input => Y5 LCD value on the display
The other points of the characteristic are calculated.

b)

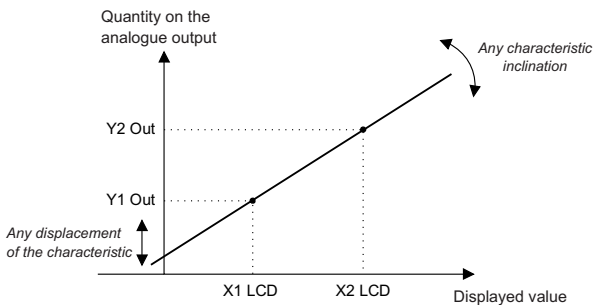

X1 LCD value on the display => wartość Y1 value on analogue output

X2 LCD value on the display => wartość Y2 value on analogue output

The other points of the characteristic are calculated.

Fig .9. Individual characteristic:

a) individual characteristic of the input,

b) individual characteristic of the analogue output.



Caution!

- In case of the transducer work with a resistance thermometer in the two-wire system, the choice of the option with an automatic compensation of conductor resistance change will cause a defective transducer work.
- The automatic compensation is switched off at the choice of **Pt1000** and **Pt500** sensors and resistance measurement up to **4 kΩ**. Connect the signal only in a two-wire system.
- In case of the display individual characteristic connection, the result on the display is converted linearly according to the introduced **Xn In** and **Yn LCD¹** parameters.
- In case of the analogue output individual characteristic connection, the measurement result is linearly converted according to the introduced **X1,2 LCD** and **Y1,2 Out** parameters.
- The transducer currently controls the value of the presently introduced parameter. In case when the introduced value overruns the upper or lower change range given on the table 1, the transducer will not carry out the parameter recording.
- In case of the **Input type** change, a simultaneous change of the unit and decimal point follows, optimally for the given input.
- The recording switching off follows in following cases: switching off the recording from the programming matrix, change of the input type, setting Cnt=0 and at the renewed connection of the transducer to the mains.

Standard parameters of the P12U transducer

Table 2

<i>Parameter description</i>	<i>Standard value</i>
Input	Pt100
Function	Off
Compens.	Manual = 0
D_P	0000.0
Cnt	1
Unit	°C
Char. In	Off

¹ n - number of points of the individual characteristic

Table 2 (continuation)

<i>Parameter description</i>	<i>Standard value</i>
no point	2
X ₁ In, Y ₁ LCD... X ₂₁ In, Y ₂₁ LCD	0
Low AI1, Low AI2	- 200.0
High AI1, High AI2	850.0
Type AI1, Type AI2	Off
DelayAI1, DelayAI2	0
Hold AI1, Hold AI2	Off
Char. Out	Off
X1 LCD, Y1 Out, X2 LCD, Y2 Out	0
Baud	9600
Mode	RTU 8N2
Address	1
Security	0
Time	00:00:00
Memory	Off
StartMem	00:00:00
DateMem	70.01.01
Interval	00:15:00

6. RS-485 INTERFACE

PU12 digital programmable transducers have a serial link in the RS-485 standard for the communication in computer systems and with other devices fulfilling the Master function. An asynchronous character MODBUS communication protocol has been implemented on the serial link. The transmission protocol describes the manners of information change between devices through the serial link.

6.1. Manners of the serial interface connection

The RS-485 standard allows the direct connection up to 32 devices on a 1200 m long single serial link.

In order to connect a greater number of devices it is necessary to use additional intermediary-separating systems.

The leading out of the interface line is given in the transducer service manual. To obtain a correct transmission it is necessary to connect the lines **A** and **B** in parallel to their equivalents in other devices. The connection must be carried out by means of screened conductors. The screen must be connected to the protective terminal in a single point.

The **GDN** line serves to the extra protection of the interface line in case of long connections. One must connect it to the protective terminal (this is not necessary for a correct interface operation).

To obtain the connection with a computer of IBM PC class, a converter USB into RS-485 of PD10 type (of LUMEL S.A. production) or an RS-483 interface card is indispensable.

The way of P12U transducers connection through a PD10 converter is presented on Fig.3.

The denotation of transmission lines for the card in the PC computer depends on the card producer.

6.2. Description of the MODBUS protocol implementation

The implemented protocol is in compliance with the specification PI-MBUS-300 Rev G of the Modicon Company.

Set of parameters of the transducer serial link in the MODBUS protocol:

- transducer address 1...247
- baud rate 2400, 4800, 9600 bit/s
- working mode ASCII, RTU
- information unit ASCII: 8N1, 7E1, 7O1,
 RTU: 8N2, 8E1, 8O1, 8N1
- maximal response time 300 ms

The parameter configuration of the serial link is described in the further part of the Service Manual. This configuration consists on the settlement of the baud rate (**Baud** parameter), device address (**Address** parameter), and the type of the information unit (**Mode** parameter).

Note: Each transducer connected to the communication network must:

- have a unique address, different from other devices connected to the network,
- the same baud rate and type of the information unit.

6.3. Description of the MODBUS protocol functions

In transducers of the P12 series following MODBUS protocol functions are implemented:

Function description Table 3

Code	Meaning
03 (03 h)	Read-out of n-registers
06 (06 h)	Recording of a single register
16 (10 h)	Recording of n-registers
17 (11 h)	Identification of the slave device

Read-out of n-registers (code 03 h)

The function is inaccessible in the publication mode.

Example: read-out of 2 registers starting from the register which the address is 1 DBDh (7613).

Request:

Device address	Function	Register address Hi	Register address Lo	Number of registers Hi	Number of registers Lo	Checksum CRC
01	03	1D	BD	00	02	52 43

Response:

Device address	Function	Number of bits	Register value 1DBD (7613)				Register value 1DBE (7614)				Checksum CRC
01	03	08	3F	80	00	00	40	00	00	00	42 8B

Recording of values into the register (code 06h)

The function is accessible in the publication mode.

Example: recording of the register which address is 1DBDh (7613)

Request:

Device address	Function	Register address Hi	Register address Lo	Register value 1DBD (7613)				Checksum CRC
01	06	1D	BD	3F	80	00	00	85 AD

Response:

Device address	Function	Register address Hi	Register address Lo	Register value 1DBD (7613)				Checksum CRC
01	06	1D	BD	3F	80	00	00	85 AD

Recording into n-registers (code 10h)

The function is accessible in the publication mode

Example: recording of 2 registers starting from the register which address is 1DBDh (7613).

Request:

Device address	Function	Register address		Number of registers		Number of bits	Value for the register 1DBD (7613)				Value for the register 1DBE (7614)				Checksum CRC
		Hi	Lo	Hi	Lo		3F	80	00	00	40	00	00	00	
01	10	1D	BD	00	02	08	3F	80	00	00	40	00	00	00	03 09

Response:

Device address	Function	Register address Hi	Register address Lo	Number of registers Hi	Number of registers Lo	Checksum (CRC)
01	10	1D	BD	00	02	D7 80

Report identifying devices (code 11h)

Request:

Device address	Function	Checksum (CRC)
01	11	C0 2C

Response:

Device address	Function	Number of bits	Device identifier	Device state	Field depending the type of device	Checksum
X	11	08	X	FF	XXXXXX	

Device address	depending on the set value,
Function	Number of function 0x11,
Number of bits	0x08,
Device identifier	0x71 - P12H 0x72 - P12S 0x74 - P12U 0x73 - P12O 0x79 - P12P
Device state	0xFF
Field depend on the device type	XXXXXX
Device name	- transmitted as an ASCII character and defines the type of transducer: H - 0x48, 48 X X X X X S - 0x53, 53 X X X X X U - 0x55, 55 X X X X X O - 0x4F, 4F X X X X X P - 0x50, 50 X X X X X
Analogue output	- field depending on the type of the analogue output, - 0x00 - voltage analogue output, X 00 X X X X - 0x01 - current analogue output, X 01 X X X X
Nr of the software version	- software version implemented into the transducer XX____ 4-byte variable of the floating type
Checksum	- 2 bytes in case of work in the RTU mode - 1 byte in case of work in the ASCII mode

Example:

Work in the RTU mode, eg: **Mode = TRU 8N2** (value 0x02 in read-out/recording case through the interface)

P12U transducer

Execution with a voltage analogue output: **00**

Nr of the software version: **1.00**

Device address set on: **Address=0x01**

For such a type of transducer the frame has the following form:

Device address	Function	Number of bits	Device identifier	Device state	Field depending of the device type	Checksum (CRC)
01	11	08	74	FF	55 00 3F 80 00 00	3D A9

6.4. Map of P12 transducer registers

Map of P12 transducer registers

Table 4

Address range	Typ of value	Description
7000-7200	Float (32 bits)	The value is placed in two successive 16-bit registers. Registers enclose the same data as 32-bit registers from the 7500 area. Registers are only for read-out.
7200-7400	Float (32 bits)	The value is placed in two successive 16-bit registers. Registers enclose the same data as 32-bit registers from the 7600 area. Registers can be read out and recorded.
7500-7600	Float (32 bits)	7500-7600 float (32 bit). The value is placed in a 32-bit register. Registers are only for read-out.
7600-7700	float (32 bits)	The value is placed in a 32-bit register. Registers can be read out and recorded.

6.5. Registers for recording and read-out

P12U transducer

Table 3

The value is placed in two successive 16-bit registers enclosing the same data as 32-bit registers from the 7600 area		The value is placed in 32-bit registers		Symbol	Recording (w) Read-out (r)	Range	Description
7200	7600	Identifier	r	-	Device identifier		
						Value	
						0x74 h	Identifier
7202	7601	Input	w/r	0...22	Type of input		
						Value	
						0	Pt100 RTD
						1	Pt500 RTD
						2	Pt1000 RTD
						3	Cu100 RTD
						4	Ni100 RTD
						5	J thermocouple
						6	K thermocouple
						7	N thermocouple
						8	E thermocouple
						9	R thermocouple
						10	S thermocouple
						11	T thermocouple
						12	R. meas. up to 400 Ω
						13	R. meas. up to 4 kΩ
						14	Volt. meas. -10... 70 mV
						15	Volt. meas. 0... 3 V
						16	Volt. meas. 0...10 V
						17	Current meas. 0... 5 mA
						18	Current meas. 0... 20 mA
						19	Volt. meas. 0... 200 V
						20	Volt. meas. 0... 600 V
						21	Current meas. 0...1 A
						22	Current meas. 0...5 A

Table 3 (continuation)

7204	7602		No occurs ¹⁾			
7206	7603		No occurs ¹⁾			
7208	7604		No occurs ¹⁾			
7210	7605		No occurs ¹⁾			
7212	7606		No occurs ¹⁾			
7214	7607		No occurs ¹⁾			
7216	7608	Compens.	w/r	0... 99999	Kind of compensation of the change of sensor working conditions	
7218	7609		No occurs ¹⁾			
7220	7610		No occurs ¹⁾			
7222	7611		No occurs ¹⁾			
7224	7612		No occurs ¹⁾			
7226	7613	D_P	w/r	0... 4	Decimal point	
					Value	
					0	00000
					1	0000,0
					2	000,00
					3	00,000
					4	0,0000
					5	Automatic decimal point
7228	7614	Cnt	w/r	0... 9999,9	Measurement time	
7230	7615	Function	w/r	0... 3	Arithmetical functions	
					Value	
					0	Switched off
					1	Reasing to a power
					2	Extraction of roots
					3	Inverse
7232	7616		No occurs ¹⁾			
7234	7617		No occurs ¹⁾			
7236	7618		No occurs ¹⁾			
7238	7619		No occurs ¹⁾			
7240	7620		No occurs ¹⁾			
7242	7621	Low AL1	w/r	- 99999... 99999	Lower threshold of alarm 1	
7244	7622	High AL1	w/r	- 99999... 99999	Upper threshold of alarm 1	
7246	7623	Type AL1	w/r	0... 4	Alarm 1 type	
					Value	
					0	Normal
					1	Switched on
					2	Switched off
					3	Manually switched on
					4	Manually switched off

Table 3 (continuation)

7248	7624	Delay AL1	w/r	0... 9999.9	Delay of alarm 1	
7250	7625	Delay AL1	w/r	0... 3	Holding of the alarm 1 signalling	
					Value	
					0	Holding switched off
					1	Signalling on LCD
					2	Relay holding
					3	Signalling on LCD and relay holding
					To erase the alarm holding, one must switch the holding off (0 value) and then return to the previously set value.	
7252	7626		No occurs ¹⁾			
7254	7627	Low AL2	w/r	- 99999... 99999	Lower threshold of alarm 2	
7256	7628	High AL2	w/r	- 99999... 99999	Upper threshold of alarm 2	
7258	7629	Type AL2	w/r	0... 4	Alarm 2 type	
					Value	
					0	Normal
					1	Switched on
					2	Switched off
					3	Manually switched on
4	Manually switched off					
7260	7630	Delay AL2	w/r	0... 9999.9	Delay of the alarm 2	
7262	7631	Hold AL2	w/r	0... 3	Holding of the alarm 2 signalling	
					Value	
					0	Holding switched off
					1	Signalling on LCD
					2	Relay holding
					3	Signalling on LCD and relay holding
					To erase the alarm holding, one must switch the holding off (0 value) and then return to the previously set value.	
7264	7632		No occurs ¹⁾			
7266	7633		No occurs ¹⁾			
7268	7634		No occurs ¹⁾			

7270	7635	Char. Out	w/r	0... 1	Characteristic of analogue output	
					Value	
					0	Charact. switched off
					1	Charact. switched on
7272	7636	X1 LCD	w/r	- 99999... 99999	Lower value of display	
7274	7637	Y1 Out	w/r	- 99999... 99999	Lower value of analogue output	
7276	7638	X2 LCD	w/r	- 99999... 99999	Upper value of display	
7278	7639	Y2 Out	w/r	- 99999... 99999	Upper value of analogue output	
7280	7640	Time	w/r	0... 99999	Current time	
					This parameter occurs with four places after the decimal point in the format gg, mmss, where: gg - means hours, mm - means minutes, ss - means seconds. In case of a wrong time introduction, the transducer will correct it automatically.	
7282	7641	Unit	w/r	0... 80 ²)	Choice of unit	
7284	7642	Memory	w/r	0... 1	Recording of measured quantity	
					Value	
					0	Charact. switched off
					1	Charact. switched on
7286	7643	Interval	w/r	0... 99.5959	Time interval of the recording	
7288	7644	year	w/r	1970... 2038	Year of the recording start	
7290	7645	month	w/r	1... 12	Month of the recording start	
7292	7646	day	w/r	1... 31	Day of the recording start	
					Parameters: Year, Month, Day are information parameters. They do not serve to define the data from which the recording is to begin, but only to inform when the recording started.	
7294	7647	Start mem.	w/r	0... 23.5959	Time of recording start	
					This parameter occurs with four places after the decimal point in the format gg, mmss, where: gg - means hours, mm - means minutes, ss - means seconds. In case of a wrong time introduction, the transducer will correct it automatically.	

7296	7648	Del.Min	w/r	0... 1	Erasing of the minimal value	
					Value	
					0	No operation
					1	Erasing of the min. value
7298	7649	Del.Max	w/r		Erasing of the maximal value	
					Value	
					0	No operation
					1	Erasing of the max. value
7300... 7310	7650...7655		No occurs ¹⁾			

7320	7660	Year of the stored value	w/r	1970... 2038	Year of the stored value in the memory
7322	7661	Month of the stored value	w/r	1... 12	Month of the stored value in the memory
7324	7662	Day of the stored value	w/r	1... 31	Day of the stored value in the memory
7326	7663	Time of the stored value	w/r	0... 23.5959	Time of the stored value in the memory
					<p>This parameter occurs with four places after the decimal point in the format gg, mmss, where:</p> <p>gg - means hours, mm - means minutes, ss - means seconds.</p> <p>In case of a wrong time introduction, the transducer will correct it automatically.</p>
7328	7664	Number of the stored value	w/r	1... 750	Number of the stored value in the memory

Table 3 (continuation)

7330	7665	Status	w/r	0... 7	Status of the operation in the buffer	
					Value	
					0	No operation
					1	Search acc. the date and time (registers 7660... 7663 and 7320... 7326)
					2	Search acc. the time (registers 7663 and 7326)
					3	Search acc. the index (registers 7664 and 7328)
					4	Load next values in to the buffer (registers 7672... 7691 and 7344... 7382)
					5	Load previous values in to the buffer (registers 7672... 7691 and 7344... 7382)
					6	Go to the first stored value in the memory
					7	Go to the last stored value in the memory
7332	7666	Stored value number	r	0... 750	Stored value number into the memory, placed in the first buffer register	
					Value	
					0	The memory is empty
					1... 750	Nr of the stored value
7334	7667	Number of recorded register	r	0... 750	Number of the recorded buffer registers	
					Value	
					0	The buffer is empty
					1... 750	Number of recorded registers
7336	7668	Year	r	1970... 2038	Year for the value in the first register	
7338	7669	Month	r	1... 12	Month for the value in the first register	
7340	7670	Day	r	1... 31	Day for the value in the first register	

Table 3 (continuation)

7342	7671	Time	r	0... 23.5959	Time for the value in the first register
					This parameter occurs with four places after the decimal point in the format gg, mmss, where: gg - means hours, mm - means minutes, ss - means seconds.
7344... 7382	7672... 7691	Buffer	r	-	Stored values, read-out from the memory
					20 registers, including 20 stored values

7400	7700	No.point	r	2... 21	Number of points of the individual characteristic
7402	7701	Char. in	r	0... 1	Individual characteristic
					Value
					0 Charac. switched off
					1 Charac. switched on
7404	7702	X1 In	w/r	- 99999... 99999	Parameters of the ind. characteristic
7406	7703	Y1 LCD			
7408	7704	X2 In			
7410	7705	Y2 LCD			
7412	7706	X3 In			
7414	7707	Y3 LCD			
7416	7708	X4 In			
7418	7709	Y4 LCD			
7420	7710	X5 In			
7422	7711	Y5 LCD			
7424	7712	X6 In			
7426	7713	Y6 LCD			
7428	7714	X7 In			
7430	7715	Y7 LCD			
7432	7716	X8 In			
7434	7717	Y8 LCD			
7436	7718	X9 In			
7438	7719	Y9 LCD			

7440	7720	X10 In	w/r	- 99999... 99999	Parameters of the ind. characteristic
7442	7721	Y10 LCD			
7444	7722	X11 In			
7446	7723	Y11 LCD			
7448	7724	X12 In			
7450	7725	Y12 LCD			
7452	7726	X13 In			
7454	7727	Y13 LCD			
7456	7728	X14 In			
7458	7729	Y14 LCD			
7460	7730	X15 In			
7462	7731	Y15 LCD			
7464	7732	X16 In			
7466	7733	Y16 LCD			
7468	7734	X17 In			
7470	7735	Y17 LCD			
7472	7736	X18 In			
7474	7737	Y18 LCD			
7476	7738	X19 In			
7478	7739	Y19 LCD			
7480	7740	X20 In			
7482	7741	Y20 LCD			
7484	7742	X21 In			
7486	7743	Y21 LCD			

1) In case of registers no occurring in the given transducer series, their values is 1E+20

2) Unit values

Table 4

Code	Unit	Code	Unit	Code	Unit	Code	Unit
0	V	21	°F	42	m ² /h	63	kPa
1	A	22	K	43	m ³ /s	64	MPa
2	μV	23	Hz	44	m ³ /min	65	mmHg
3	mV	24	kHz	45	m ³ /h	66	bar
4	KV	25	MHz	46	l	67	rad
5	MV	26	mAh	47	l/s	68	mOhm
6	μA	27	Ah	48	l/min	69	Ohm
7	mA	28	kAh	49	l/h	70	kOhm
8	kA	29	Wh	50	l/m ²	71	MOhm
9	MA	30	kWh	51	l/m ³	72	GOhm
10	mW	31	MWh	52	kg/s	73	%
11	W	32	m/s	53	kg/min	74	°
12	kW	33	μm	54	kg/h	75	turns
13	MW	34	mm	55	ms	76	rps
14	var	35	cm	56	s	77	rpm
15	kvar	36	m	57	h	78	rph
16	Mvar	37	km	58	mN	79	m/h
17	VA	38	m ²	59	N	80	km/h
18	kVA	39	m ³	60	kN		
19	MVA	40	m ² /s	61	Pa		
20	°C	41	m ² /min	62	hPa		

6.6. Registers only for read-out

P12U transducer

Table 5

The value is placed in two successive 16-bit registers enclosing the same data as 32-bit registers from the 7600 area	The value is placed in 32-bit registers	Name	Recording (z) Read -out (o)	Unit	Name of the quantity
7000	7500	Identifier	r	-	Constant identifying the device
					0x71 - P12H 0x72 - P12S 0x74 - P12U 0x73 - P12O 0x79 - P12P
7002	7501	Status	r	-	Status is the register describing the transducer current state
7004	7502	Steering	r	%	It is the register describing the steering of the analogue output
7006	7503	Min	r	-	Minimal value of the currently measured value
7008	7504	Max	r	-	Maximal value of the currently measured value
7010	7505	Measured value	r	-	Currently measured value
7012	7506	No occurs ¹⁾			
7014	7507	Hour	r	gg, mmss	Current time
7016	7508	No occurs ¹⁾			
7018... 7096	7509... 7548	No occurs ¹⁾			

¹⁾ In case of registers no occurring in the given transducer series, their values is 1E+20

Caution!

- while exceeding the upper or the lower parameter range, „ displayed value”, „minimum”, „maximum” are set on the 1E+20 value.

For the **Cnt=0** parameter (measurement switching off or display blanking), the „ maximum“, „minimum“ or „displayed value“ parameters are set on the **1E +20** value

Description of the status register

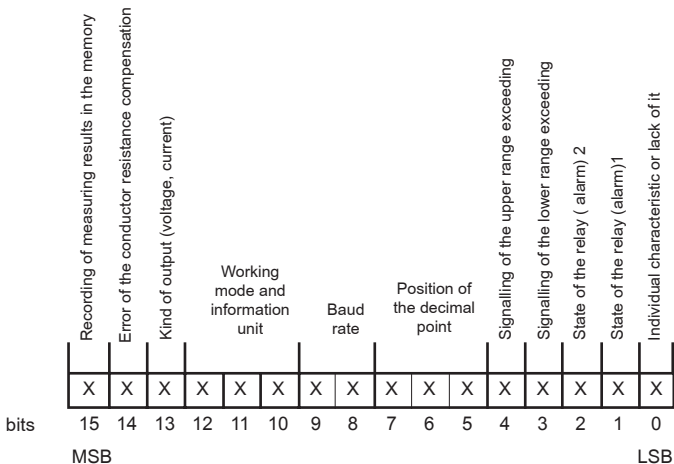

Bit-15 Recording of measurement results in the memory

- 0 - recording switched off into the memory
- 1 - recording switched on into the memory

Bit-14 Error of the conductor resistance compensation

- 0 - lack of error
- 1 - signalling of the compensation error

Bit-13 Kind of output (voltage, current)

0 - voltage

1 - current

Bit-12...10 Working mode and information unit

000 - interface switched off

001 - 8N1 - ASCII

010 - 7E1 - ASCII

011 - 7O1 - ASCII

100 - 8N2 - RTU

101 - 8E1 - RTU

110 - 8O1 - RTU

111 - 8N1 - RTU

Bit-8...9 Baud rate

00 - 2400 bit/s

01 - 4800 bit/s

10 - 9600 bit/s

Bit-5...7 Position of the decimal point

000 - lack

001 - 0.0

010 - 0.00

011 - 0.000

100 - 0.0000

101 - automatic decimal point

Bit-4 Signalling of the upper overrunning of the range

0 - normal work

1 - range overrunning

Bit-3 Signalling of the lower overrunning of the range

0 - normal work

1 - range overrunning

Bit-2 Relay (alarm) 2 state

0 - switched off

1 - switched on

Bit-1 Relay (alarm)1 state

- 0 - switched off
- 1 - switched on

Bit-0 Individual characteristic

- 0 - individual characteristic switched off
- 1 - individual characteristic switched on

7. TECHNICAL DATA

INPUTS:

Pt100	(- 200... + 850)°C
Pt500	(- 200... + 850)°C
Pt1000	(- 200... + 850)°C
Cu100	(- 50... + 180)°C
Ni100	(- 60... + 180)°C
Thermocouple J (Fe-CuNi)	(- 100... + 1200)°C
Thermocouple K (NiCr-NiAl)	(- 100... + 1370)°C
Thermocouple N (NiCrSi-NiSi)	(- 100... + 1300)°C
Thermocouple E (NiCr-CuNi)	(- 100... + 900)°C
Thermocouple R (PtRh13-Pt)	(0... + 1760)°C
Thermocouple S (PtRh10-Pt)	(0... + 1760)°C
Thermocouple T (Cu-CuNi)	(- 100... + 400)°C
Resistance measurement	0... 400 Ω
Resistance measurement	0... 4000 Ω ;
Voltage measurement	- 10... 70 mV, input resistance > 9 MΩ ;
Voltage measurement	0...3 V, 0...10 V, 0... 200 V, 0... 600 V, input resistance > 4,2 MΩ ;
Current measurement	0... 5 mA, 0... 20 mA, input resistance < 4 Ω
Current measurement	0...1 A, 0... 5 A, input resistance 10 mΩ ±10%
Current flowing through the RTD	< 200 μA
Resistance of conductors connecting the RTD with the transducer	< 20 Ω /conductor
Thermocouple characteristics	acc. EN 60584-1.
RTD characteristics	acc. EN 60751+A2

OUTPUTS:

■ Analogue outputs galvanically insulated with a range resolution of 0.025%:

- current programmed 0/4... 20 mA load resistance $\leq 500 \Omega$
- or voltage programmed 0...10 V load resistance $\geq 500 \Omega$

■ Relay outputs:

- two relays; voltageless and make contacts - maximal load:
 - voltage 250 V a.c., 150 V d.c.,
 - current 5 A 30 V d.c., 250 V a.c.,
 - resistance load 1250 VA, 150 W,
- programmable alarm thresholds,
- three types of alarms,
- hysteresis defined by means of the lower and upper alarm threshold,
- signalling of alarm operation on the LCD display.

■ Digital output:

- interface RS-485,
- transmission protocol MODBUS,
- ASCII 8N1, 7E1, 7O1,
- RTU 8N2, 8E1, 8O1, 8N1,
- baud rate 2400, 4800, 9600 bauds,
- max. response time to the query frame 300 ms.

■ Communication parameters of the programmer socket:

- interface UART
- data bit 8
- parity lack
- stop bit 1
- baud rate 9600 bit/s
- flow control lack

■ Storage parameters:

- transducer storage (recording) 750 samples
- minimal recording interval 1 s

■ Accuracy class

0.2
0.3 for Cu100 and Ni100
minimal sub-range: 4 times smaller
than the full range

<p>■ Additional error from ambient temperature changes:</p>	<p>± (0.1% of the range /10K) ± (0.2% of the range /10K) for R, S or T thermocouples</p>
<p>■ Conversion time:</p> <p>– P12U-1</p> <p>– P12U-2</p>	<p>< 200 ms min. 200 ms (averaging time min. 100 ms + output response time = 100 ms)</p>
<p>■ Rated operating conditions:</p> <p>– supply voltage depending on the execution code</p> <p>– supply voltage frequency</p> <p>– ambient temperature</p> <p>– storage temperature</p> <p>– air relative humidity</p> <p>– preheating time of the transducer</p> <p>– working position</p>	<p>85...<u>230</u>...253 V a.c./d.c. 20...<u>24</u>...50 V a.c./d.c. 40...<u>50/60</u>...440 Hz - 25...<u>23</u>...55°C - 25...+85°C < 95% (inadmissible condensation) 10 min any (on a 35 mm DIN rail)</p>
<p>■ Sustained overload:</p> <p>– thermocouples, resistance thermometers</p> <p>– measurement of voltage, current and resistance</p>	<p>1 % 20 %</p>
<p>■ Short duration overload (3 sec):</p> <p>– inputs of sensors and voltage 60 mV</p> <p>– voltage input ≥ 3 V</p> <p>– current input</p>	<p>30 V 10 Un (< 1000 V) 3 In</p>
<p>■ Display field (w P12U-2)</p>	<p>LCD 2x8 display indication range: - 99999... 99999</p>
<p>■ Servicing (in P12U-2)</p>	<p>four keys: </p>
<p>■ Ensured protection degree through the case</p>	<p>IP 40</p>

■ Dimensions	45 x 120 x 100 mm
■ Mass	< 300 g
■ Fixing	on a 35 mm DIN rail
■ Power consumption	< 4 VA
■ Resistance against current decay	acc. EN 50082-2
■ Electromagnetic compatibility:	
– immunity	acc. EN 61000-6-2
– emissions	acc. EN 61000-6-4
■ Security requirements acc. IEC 61010-1:	
– installation category	III
– pollution degree	2
– phase-to-earth maximal working voltage	600 V a.c.



8. BEFORE A DAMAGE WILL BE SUBMITTED

In case of incorrect symptoms please to acquaint with the below table.

SYMPTOMS	PROCEDURE
1. The transducer diode does not light. Lack of any indications.	Check the connection of the mains cable.
2. The time (eg. 12:34:43) and the „TIME” inscriptions are alternately displayed with the „P12U” inscription on the display.	The number of measurements Cnt=0 has been introduced. The transducer is working in the SLEEP mode.
3. Inscriptions Over.Hi or Over.Lo are displayed on the display.	Check the correctness of the input signal connection. See the service manual. Check also the setting of D_P and Char.In parameters.

<p>4. A signal inconsistent with our expectations occurs on the transducer output.</p>	<p>One must check whether the load resistance of the analogue output is compatible with the technical data. Check whether the individual characteristic is not switched on. In case of necessity make the change of the individual characteristic parameters or introduce factory parameters: Par.fact.</p>
<p>5. Lack of possibility to enter into the programming mode. The inscription Security error is displayed.</p>	<p>The programming mode is secured by the password. In case when the user will forgot which password had been introduced, he should phone the nearest service workshop.</p>
<p>6. Lack of certainty if all character fields of the display are efficient.</p>	<p>Enter into the programming matrix and switch the display test on. The character fields are successively lighted in the first line till the lighting of the last field. Then, the whole line is lighted. This operation is repeated for the second line. If otherwise, submit the fault to the nearest service workshop.</p>
<p>7. During the moving along the programming mode, values not conform to the range of changes given in the table 1, occur on the display.</p>	<p>Check whether the individual characteristic is not switched on. In case of needs, enter into the programming matrix and accept the Par. fact parameter.</p>
<p>8. A result inconsistent with our expectations appears on the display.</p>	<p>Check whether the individual characteristic is not switched on. In case of needs, enter into the programming matrix and accept the Par. fact parameter. The transducer will introduce parameters acc. the table 2.</p>
<p>9. Symbols of X1In, X2In, Y1 LCD, Y2 LCD and successive parameters are not displayed in the programming mode.</p>	<p>In case of the switched individual characteristic off, the mentioned symbols are avoided.</p>

<p>10. In spite of the alarm threshold overrunning, the alarm does not switch on and lack of signalling on the display.</p>	<p>Check the introduced delay into the alarm operation. If possible correct Delay AI1, Delay AI2 parameters.</p>
<p>11. In spite of the relay switching-off, the alarm occurrence is still signalled on the display. In spite of the retract of the alarm signalling on the display, the relay is still switched on.</p>	<p>Check whether the support of the alarm signalling or the relay is switched on Hold AI1, Hold AI2 parameters. In case of necessity switch it off.</p>
<p>12. Lack of possibility to erase the signalling from the display or switch the relay off by means of the combination of keys when the parameter of the alarm signalling support is switched on.</p>	<p>The alarm is still operating. The erased alarm signalling from the display is immediately displayed again. The erased relay is switched on again, at once.</p>
<p>13. In spite of the fact that the alarm still lasts, the erased alarm signalling from the display is not displayed again or/and the relay remains switched off.</p>	<p>Check whether a delay in the relay operation was not introduced. Delay AI1, Delay AI2 parameters.</p>
<p>14. Instead to display the measuring result, the transducer displays the parameter symbol and its value.</p>	<p>The transducer works in the review mode or the programming matrix. Press the erase key.</p>
<p>15. A delay of the alarm operation was introduced, e.g. 30 s, but the alarm, after this time did not operate.</p>	<p>The persisting alarm state was shorter than the programmed one, i.e. a state of the alarm retract occurs during the alarm operation. In that case, the transducer begins to deduct the time from the beginning.</p>
<p>16. The transducer does not communicate with the computer through the RS-485 interface.</p>	<p>Check if the interface conductors were correctly connected (A, B, GND). Then, check the setting of the interface in the programming matrix (Mode, Baud, Address). These parameters must be the same as in the used software.</p>

17. The transducer does not communicate with the computer through the PD14 programmer.

Check whether the PD14 programmer was correctly connected. Check if in the used software the proper communication port was chosen. The programmer works only with one transducer socket.

9. EXAMPLES OF P12U TRANSDUCER PROGRAMMINGS

Example 1 - Programming of the individual characteristic

We want to program such that:

- to the value 1.00 mA, will correspond the value 1.00 on the display,
- to the value 2.00 mA, will correspond the value 50.00 on the display,
- to the value 3.00 mA, will correspond the value 200.00 on the display,
- to the value 10.00 mA, will correspond the value 200.00 on the display,
- to the value 12.00 mA, will correspond the value 170.00 on the display,
- to the value 20.00 mA, will correspond the value 80.00 on the display, (6 points of the individual characteristic),

one must :

- enter into the programming mode and choose the **D_P** parameter responsible for the decimal point. Set the decimal point on **00000**,
- choose the **Char.in** parameter and press the  key,
- choose the **no.point** parameter and introduce the value 6,
- choose the **X1 IN** parameter and introduce the value 1,
- choose the **Y1 LCD** parameter and introduce the value 10,
- choose the **X2 IN** parameter and introduce the value 2.00,
- choose the **Y2 LCD** parameter and introduce the value 50,
- choose the **X3 IN** parameter and introduce the value 3,
- choose the **Y3 LCD** parameter and introduce the value 200,
- choose the **X4 IN** parameter and introduce the value 10.00,
- choose the **Y4 LCD** parameter and introduce the value 200,
- choose the **X5 IN** parameter and introduce the value 12.00,
- choose the **Y5 LCD** parameter and introduce the value 170,
- choose the **X6 IN** parameter and introduce the value 20.00,

- choose the **Y6 LCD** parameter and introduce the value 80,
- choose the **Char.In** parameter and switch the individual characteristic On

Example 2 - Alarm programming with hysteresis

If we want to program the alarm 1 operation in order that at the 850°C value the alarm was switched on, whereas it was switched off at the 100°C value, and the alarm 2 operation in order that at the 1000°C it was switched off and switched on at the - 199°C value, one must:

- enter into the programming mode, choose the **Low AI1** parameter and introduce the 100 value,
- transit on the **High AI1** parameter and introduce the 850 value,
- transit on the **type AI1** parameter and choose the function marked as **Normal**,
- choose the **Low AI2** parameter and introduce the 1000 value,
- transit on the **High AI2** parameter and introduce the - 199 value,
- transit on the **type AI2** parameter and choose the **Normal** function.

Example 3 - Alarm programming in the set interval with delay

If we want that the alarm 1 was switched on in the interval from 100 V to 300 V and operated only after 10 s, one must:

- enter into the programming mode, choose the **Low AI1** parameter and introduce the 100 value,
- transit on the **High AI1** parameter and introduce the 300 value,
- transit on the **type AI1** parameter and choose the **On** function,
- transit on the parameter **Delay AI1** parameter and introduce the 10.0 value,

In case of continuation of the alarm state more than 10.0 seconds, the transducer will switch the alarm relay on or/and signal this on the display.

Example 4 - Programming of the analogue output

If we want to program in order that the 4.00 mA value will correspond to the displayed 0.00 mA value on the analogue output, whereas the 20 mA value will correspond to the 20 mA value, one must:

- enter into the programming mode, choose the **Char. out** parameter and switch on the individual characteristic,
- choose the **X1 LCD** parameter and introduce the 0.00 value,
- transit on the **Y1 OUT** parameter and introduce the 4.00 value,
- transit on the **X2 LCD** parameter and introduce the 20.00 value,
- transit on the **Y2 OUT** parameter and introduce the 20.00 value.

10. EXECUTION CODES

Execution codes of the P12U transducer

Table 6.

P12U PROGRAMMABLE TRANSDUCER	X	XX	X	X	X	XX	X
Kind of transducer:							
without a display							1
with a display							2
Input signal*:							
Write the input signal code from the table 7		XX					
Output signal:							
voltage 0... 10 V							1
current 0... 20 mA							2
current 4... 20 mA							3
current 0... 5 mA							4
on order**							X
Supply:							
85... 253 V a.c./d.c.							1
20... 50 V a.c./d.c.							2
Kind of terminals:							
socked - screw plug							0
on order***							X
Version:							
standard							00
custom-made**							XX
Acceptance tests:							
without an extra quality inspection certificate							8
with an extra quality inspection certificate							7
acc user's agreement**							X

* The transducer has an universal input. One must give in order the code of the input signal which will be programmed.

** After agreeing by the producer.

*** Possible execution with self-locking sockets.

The transducer maintains its class to the fourfold decrease of the basic range of the input signal. In the PU12-1 transducer, besides the basic range, one must give the required sub-range in remarks. In case when the given sub-range is smaller than the basic range divided by four, one must precise the input signal on the XX order.

Table 7

Input signal		Code of the input signal
Resistance thermometer Pt100	(- 200... + 850)°C	00
Resistance thermometer Pt500	(- 200... + 850)°C	01
Resistance thermometer Pt1000	(- 200... + 850)°C	02
Resistance thermometer Cu100	(- 50... + 180)°C	03
Resistance thermometer Ni100	(- 60... + 180)°C	04
Thermocouple J - (Fe-CuNi)	(- 100... + 1200)°C	05
Thermocouple K - (NiCr-NiAl)	(- 100... + 1370)°C	06
Thermocouple N - (NiCrSi-NiSi)	(- 100... + 1300)°C	07
Thermocouple E - (NiCr-CuNi)	(- 100... + 900)°C	08
Thermocouple R - (PtRh13-Pt)	(0... + 1760)°C	09
Thermocouple S - (PtRh10-Pt)	(0... + 1760)°C	10
Thermocouple T - (Cu-CuNi)	(- 100... + 400)°C	11
Resistance measurement up to 400 Ω	(0... 400 Ω)	12
Resistance measurement up to 4 kΩ	(0... 4000 Ω)	13
Voltage measurement: - 10... 70 mV	(- 10... + 70) mV	14
Voltage measurement: 0... 3 V	(0... 3) V	15
Voltage measurement: 0... 10 V	(0... 10) V	16
Current measurement: 0... 5 mA	(0... 5) mA	17
Current measurement: 0... 20 mA	(0... 20) mA	18
Voltage measurement: 0... 200 V	(0... 200) V	19
Voltage measurement: 0... 600 V	(0... 600) V	20
Current measurement: 0... 1 A	(0... 1) A	21
Current measurement: 0... 5 A	(0... 5) A	22
on order**		XX

CODING EXAMPLES:

Transducer with a basic range:

P12U 2 16 3 1 0 00 8 code means:

The execution of a P12U transducer with following requirements:

- 2 - with a display,
- 16 - programmed by the manufacturer to the input signal: 0...10 V,
- 3 - analogue current output: 4...20 mA,
- 1 - supply voltage: 85...253 V a.c./d.c.,
- 0 - socket-screw plug terminals,
- 00 - standard execution,
- 8 - without an extra quality inspection certificate.

Transducer with a measuring sub-range:

P12U 1 05 1 1 0 00 8 code and sub-range: 0...400°C range means:

The execution of a P12U transducer with following requirements:

- 1 - without a display,
- 05 - programmed by the manufacturer to co-operate with a J (Fe-CuNi) thermocouple, in the sub-range 0...400°C,
- 1 - output signal: 0...10 V,
- 1 - supply voltage: 85...253 V a.c./d.c.,
- 0 - socket-screw plug terminals,
- 00 - standard execution,
- 8 - without an extra quality inspection certificate.

11. MAINTENANCE AND GUARANTEE

The P12U transducer does not require any periodical maintenance.

In case of some incorrect unit operations:

1. In the period defined in the guarantee card from the date of purchase:

In case of any damage or incorrect operation one should take the transducer down from the installation and return it to the Producer's Quality Control Dept.

If the unit has been used in compliance with the instructions, the producer guarantees to repair it free of charge.

The disassembling of the housing can cause the cancellation of the granted guarantee

2. After the guarantee period:

One should turn over the transducer to repair in a certified service workshop.

Spare parts are available for the period of five years from the date of purchase.

The producer reserves the right to make changes in design and specifications of any products as engineering advances or necessity

SALES PROGRAM

- DIGITAL and BARGRAPH PANEL METERS
- MEASURING TRANSDUCERS
- ANALOG PANEL METERS (DIN INSTRUMENTS)
- DIGITAL CLAMP-ON METERS
- INDUSTRIAL PROCESS and POWER CONTROLLERS
- CHART and PAPERLESS RECORDERS
- POWER CONTROL UNITS AND SOLIDE-STATE RELAYS
- 1-PHASE and 3-PHASE WATT-HOUR METERS
- ELEMENTS OF INTEGRATION SYSTEMS
- ACCESSORIES for MEASURING INSTRUMENTS (SHUNTS)
- MEASURING SYSTEMS (ENERGY, HEAT, CONTROL)
- CUSTOM – MADE PRODUCTS ACCORDING CUSTOMER'S REQUIREMENTS

**MEASUREMENT
CONTROL
RECORDING**

WE ALSO OFFER OUR SERVICES IN THE PRODUCTION OF:

- ALUMINIUM ALLOY PRESSURE CASTINGS
- PRECISION ENGINEERING and THERMOPLASTICS PARTS
- SUBCONTRACTING of ELECTRONIC DEVICES (SMT)
- PREASSURE CASTINGS and OTHER TOOLS

QUALITY PROCEDURES:

According to ISO 9001 and ISO 14001 international requirements.
All our instruments have CE mark.
For more information, please write to or phone our Export Department.



Lubuskie Zakłady Aparatów Elektrycznych - LUMEL S.A.

ul. Sulechowska 1, 65-022 Zielona Góra, Poland

Tel.: (48-68) 32 95 100 (exchange)

Fax: (48-68) 32 95 101

www.lumel.com.pl

e-mail: lumel@lumel.com.pl

Export Department:

Tel.: (48-68) 329 53 02 or 53 04

Fax: (48-68) 325 40 91

e-mail: export@lumel.com.pl