

Multi-channel Meter

Energom-2600

User Manual

Version: 1.4

Read me

When you use EnergoM-2600 series multi-channel meter, be sure to read this user manual carefully, and be able to fully understand the implications, the correct guidance of operations in accordance with user manual, which will help you make better use of EnergoM-2600 series multi-channel meter, and help to solve various problems at the scene.

1. Before the meter turn on the power supply, be sure that the power supply within the provisions of the instrument;
2. When installation, the current input terminal must be non-open, voltage input terminals must be Non-short circuit;
3. Communication terminal (RS232/RS485 or Ethernet) is strictly prohibited to impose on high pressure;
4. Be sure the instrument wiring is consistent with the internal system settings;
5. When communicating with the PC, instrument communication parameters must be consistent with the PC.



- **Please read this user manual carefully**
- **Please save this document**

Directory

CONTENTS	Page
1. - SUMMARIZE.....	- 3 -
2. - ELECTRICITY METERING.....	- 5 -
2.1. - THREE PHASE METERING MODEL.....	o
2.2. - SINGLE PHASE METERING MODEL.....	o
3. - SPECIFICATIONS	- 6 -
4.- INSTALLATION AND START-UP.....	- 8 -
4.1.- INSTALLATION.....	- 8 -
4.2. - CONNECTION TERMINAL	- 11 -
5. SCREEN DISPLAY	- 14 -
5.1. - PANEL DIAGRAM	- 14 -
5.2.- DISPLAY UNIT CONNECTION	- 14 -
6. - OPERATION MODE	- 15 -
7. - SETUP PROCEDURE	- 25 -
7.1.- INPUT PASSWORD.....	- 25 -
7.2. - INPUT SIGNAL SELECTION	- 25 -
7.3. - COMMUNICATION PREFERENCES.....	- 29 -
7.4. - DIGITAL OUTPUT SETTING	- 31 -
7.5. - TIME AND DATE SETTING.....	- 33 -
7.6. - MUTI-TARIFF SETTING	- 36 -
7.7. - SYSTEM SETTING.....	- 38 -
7.8. – MENU STRUCTURE	- 40 -
7.9.- DISPLAY CHARACTER INSTRUCTIONS	- 43 -
8.- COMMUNICATION INTERFACE	- 44 -
8.1.- CONNECTION FOR THE RS485 BUS	- 44 -
8.2.- MODBUS © PROTOCOL	- 44 -
8.3. - REGISTER ADDRESS TABLE	- 45 -
8.4.- EXAMPLE.....	- 51 -
9. - SAFETY CONSIDERATIONS	- 52 -
10. - MAINTENANCE.....	- 52 -

1. - SUMMARIZE

Energom-2600 series provides a compact and robust metering solution, enable reliable monitoring of commercial building electrical or industry loads with a low installation cost-per-point by combining sub-metering.

The device performs real-time metering, measures energy consumption and generation, multi-tariff time-of-use (TOU) and monitors power quality for advanced communications options including Modbus via RS485, I/O communications provide for extensive reliable data exchange.

Max 18 channel circuits for single-phase circuits(Energom-2601) or 6 channel for three-phase circuits (Energom-2603). Multiple units can be connected together to meter unlimited number of circuits.

The versatility of Energom-1000 meters are ideal for multi-tenant or departmental metering applications within office towers, condominiums, apartment buildings, shopping centers and other multi-user environments.

Measurement Functions

Real-time electrical parameter

Voltage: Line Voltage (L-L); Phase Voltage(L-N)

Current: Current per channel (A)

Power and Power Factor: Total power Reactive Power(kW), Apparent Power (VA), Power Factor and for per channel

Frequency: System Frequency (Hz)

Demand: Total Power, Reactive Power, Apparent Power per channel

Energy Function

Energy (kWh) measurement meeting international standards, accuracy is Class 0.5.

Optional Time of Use (TOU): 12 segments, 4 Tariffs record, max three-month data for each channel.

Over/Under Limit Alarming

Users can select parameters and set their set points. An alarm will be triggered when the set point is reached. At the same time, sound and light signals could be sent out via relay output. The time and reason of an alarm event will be recorded.

Power Quality Analysis

Optional power quality parameters such as voltage and current THD, Odd harmonic distortion (Total Odd HD), even harmonic distortion (Total Even HD), 2 ~ 31 times the harmonic content, Current K-factor (KF), crest factor (CF), telephone interference factor (THFF), voltage and current unbalance etc.

I/O Option

Standard 1 channels output ports provide energy (kWh) pulse output and time pulse output; optional 6 channels digital inputs (DI) provide pulse counting from water, electricity and gas meter, and monitor switch status; optional 2 channels relay outputs (DO) react upon alarming conditions.

Communication and Network

Supports RS485 communication open protocol: Modbus RTU;

2. - ELECTRICITY METERING

Energom-2600 series has two models:

Energom-2603 Three phase measurement, max connect 6 channel three phase circuit.

Energom- 2601 Single phase measurement, max connect 18 channel single phase circuit.

The Energom delivers the of parameters listed by RS485 ports, on front panel have 1.7inch screen to show various parameters and state of meter on each page jump, work with 4 key button can do configuration of device. For more details of operation and screen introduce please refer to the subsequent chapter.

Function overall

	Function	Parameter	
Real-time Parameter	Voltage	Ua, Ub, Uc / Uab, Ubc, Uca	●
	Current	Per channel / Per phase	●
	Power	Per channel / Per phase	●
	Reactive Power	Per channel / Per phase	●
	Apparent Power	Per channel / Per phase	●
	Power Factor	Per channel / Per phase	●
	Frequency	Per channel / Per phase	●
Energy	Active Energy +	Per channel	●
	Reactive Energy +	Per channel	●
	Active Energy -	Per channel	●
	Reactive Energy -	Per channel	●
	TOU	4 Tariffs, 12 Segment	○
Power Quality	THD	UTHD, UTOHD, UTEHD, UTHFF, UCF ITHD, ITOHD, ITEHD, IKF	○
	Individual Harmonic	2nd-31st	○
	Voltage Unbalance	/	○
	Current Unbalance	/	○
	Power Demand	Last three month demand record	○
	Voltage Deviation	/	○
Alarming	Virtual alarm	5 alarm trip	○
I/O	1PO	Default 5000imp/kWh VCC<48V, Iz<50mA	○
	2DO	5A@250Vac / 5A@30Vdc	○
	6DI	Ri<500Ω open, Ri>100kΩ Closed	○
Communication	RS485	RS485, Modbus-RTU	●

Notes: "●" for Standard; "○" for Optional;

3. - SPECIFICATIONS

Reference standard:

Basic electricity: IEC 61557-12:2018

Active energy: IEC 62053-21:2020

Reactive energy: IEC 62053-23:2020

Accuracy standards

Parameter	Accuracy	A phase	B phase	C phase	All
Voltage	0.2	V1	V2	V3	
Current	0.2	A1	A2	A3	
Active Power	0.5	W1	W2	W3	W
Reactive Power	0.5	var1	var2	var3	var
Apparent power	0.5	VA1	VA2	VA3	VA
Power Factor	0.5	PF1	PF2	PF3	PF
Active Energy	1				Wh
Reactive Energy	2				varh
Frequency	0.1				Hz

Input

Voltage: Rated 40~450V

Current: Rated 5A (Optional 1A)

Frequency: 45-65Hz

Overload

Current: 1.2 times rated continuous; 5 seconds for 10 times of the rated

Voltage: 30 seconds for 2 times of the rated

Dielectric strength

IEC/EN 61010-1:2012

2kV AC RMS 1 minute, between input / output / case / power supply

EMC Test

	standard	Test voltage
Electrostatic discharge immunity test:	IEC-61000-4-2 level 4	8kV
Electrical fast transient burst immunity test	IEC61000-4-4 level 3	Input 1kV; Power supply 2kV
Surge (Shock) immunity test	IEC61000-4-5 level 4	common mode test voltage 4kV

Work environment

Temperature: -15C~ +55C

Humidity: RH 20%~95% (No condensation)

Storage Conditions

Temperature: -25C~+70C

Humidity: RH 20%~95%

Working Power

AC/DC 90-240V, 45-65Hz

Or DC 20-60V (Optional)

Maximum power consumption 6W

Dimensions

L × H × D =228mm×120mm×65mm

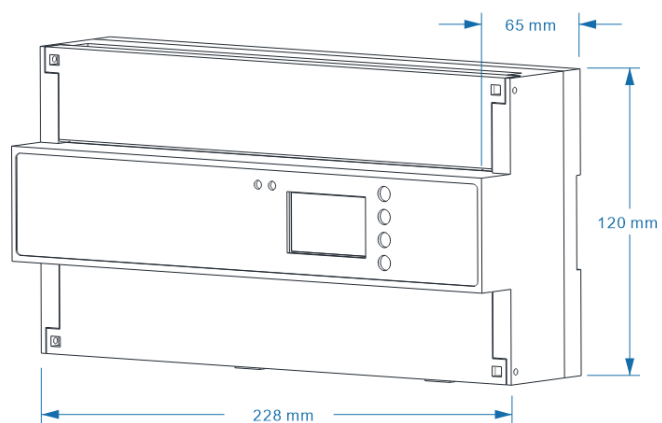

Installation

35mm Din-Rail

4.- INSTALLATION AND START-UP



The manual you hold in your hand contains information and warnings that the user should respect in order to guarantee a proper operation of all the instrument functions and keep it in safety conditions. The instrument must not be powered on and used until its definitive assembly is on the cabinet's door.

If the instrument is not used as manufacturer's specifications, the protection of the instrument will be damaged.

When any protection failure is suspected to exist (for example, it presents external visible damages), the instrument must be immediately powered off. In this case contact a qualified service representative.

4.1.- Installation

Mounting

Energom-2600 is DIN rail mounted, which fits 35 mm standard rails.

- Step-1 Fasten a section of 35 mm DIN rail (at least 8 inches long) to the mounting surface with appropriate hardware.
- Step-2 Use the white plastic clips on the back of the Energom-2600 meter to clip the meter onto the rail.
- Step-3 Verify that the meter is securely fastened to the wall.

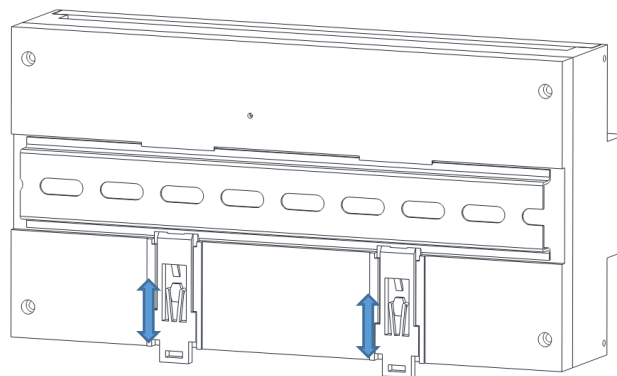

There have two flaps cover, can sealed by lead wire to protect unauthorized access terminal block, to achieve physical anti-theft function. Also capable of completely shielding the terminal head to prevent accident electrical shock.

Note that with the instrument powered on, the terminals could be dangerous to touch and cover opening actions or elements removal may allow accessing dangerous parts.

Therefore, the instrument must not be used or operation key button until this is completely installed and closed the cover.

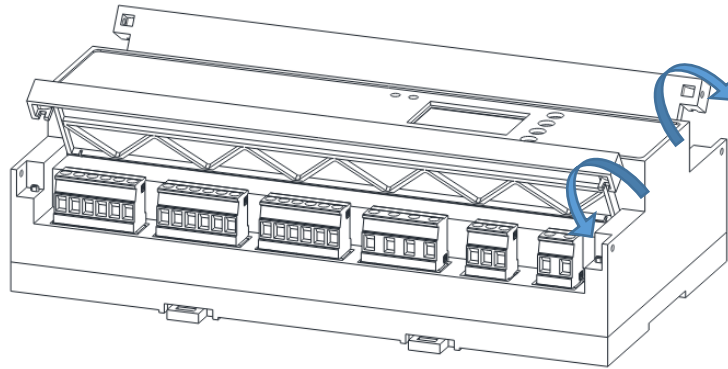

Notes:

Input signal: EnergoM-2600 using a separate acquisition calculate for each measurement channel, to ensure consistent in use, for different load forms, it's a variety of connection mode.

Access wire shall be met 1.5 square mm,

A. Voltage input:

Input voltage should not exceed the rated input voltage products 450V,

Otherwise, you should use external VT. Suggest 1A fuse be installed in the voltage input side.

B. Current Input:

Standard input current is 5A or 1A, if greater than 5A/1A should use external CT.

When the CT is connected with other meters, make sure wiring methods be used in series.

Forbid to install a CT on the live feeder wire with open secondary leads. This can be extremely dangerous!!

Before remove the current input connection, must be sure to disconnect the primary circuit or shorted secondary circuit of CT.

C. Please make sure that the input voltage and current corresponding to the same phase sequence, and the same direction; Otherwise, the Values and symbols will be wrong!! (Power and Energy)

Always observe the physical orientation of CT (P1 - P2) when installing on the feeder wire.

Always pay attention to wiring polarity and phasing when terminating the CT leads to the EnergoM-2600.

S1 connect to Ix*, S2 connect to Ix.

The input network configuration of instrument depends on the CT number of the system:
in the condition of 2 CT, select the three-phase, three-lines two components;
in the condition of 3 CT, select the three-phase, four-lines three component mode.

Instrument connection mode, set of the instrument (programming input network NET) should be the same load wiring as measured wiring. Otherwise, the measurement instrument will lead to incorrect voltage or power.

In three-phase 3 wire mode, measurement and shows the line voltage;

In three-phase 4 wire mode, measurement and shows the phase voltage and line voltage both.

Auxiliary power:

Energom-2600 Series with universal (AC / DC) power input, if not for a special statement, we provide the 90-240ac/dc power interface for standard products, please ensure that the auxiliary power can match with meter to prevent unexpected damage.

A. Suggest install 1A fuse in the fire line side.

B. For the areas with poor power quality, suggest install lightning surge suppressor and rapid burst suppressor to prevent lightning strikes.

4.2. - Connection Terminal

Three-phase model terminal (EnergoM-2603)

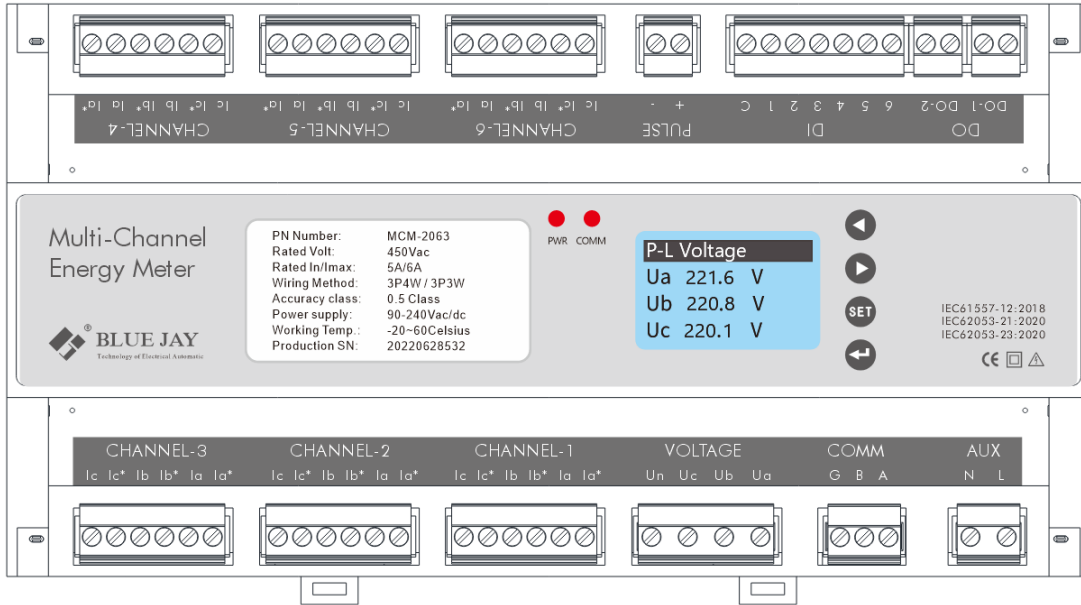

Single-phase mode terminal (EnergoM-2601)

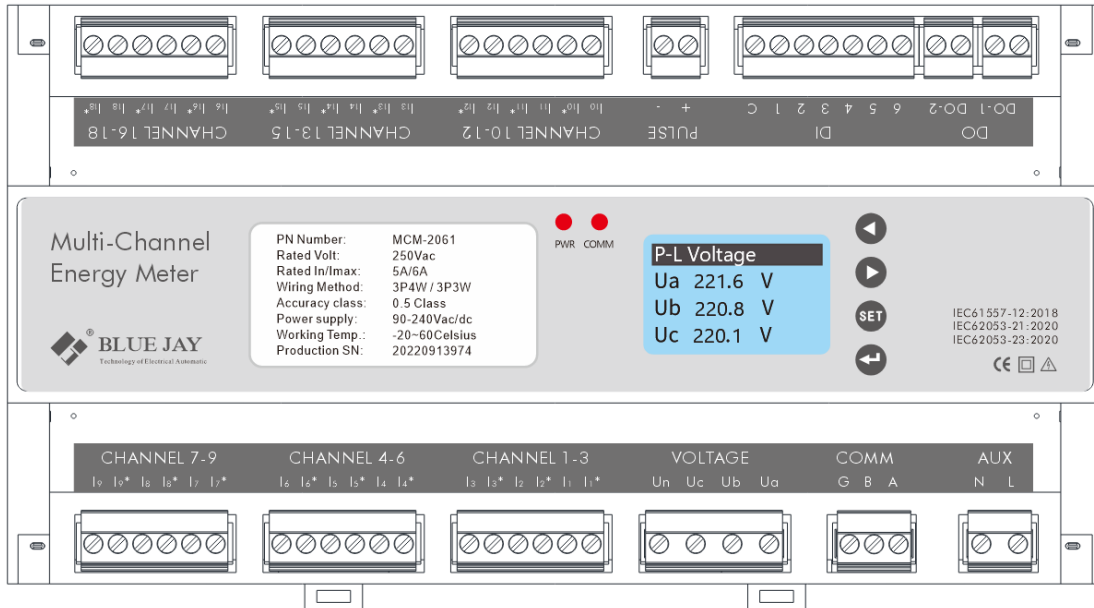

Notes:

The terminal pin definition may change depends on customer order; please refer to the label on the meter!

If do not optional DO/DI, no internal circuit be install, the terminal block is disable.

Typical wiring- 3P4W & 3P3W (max 6 channels)

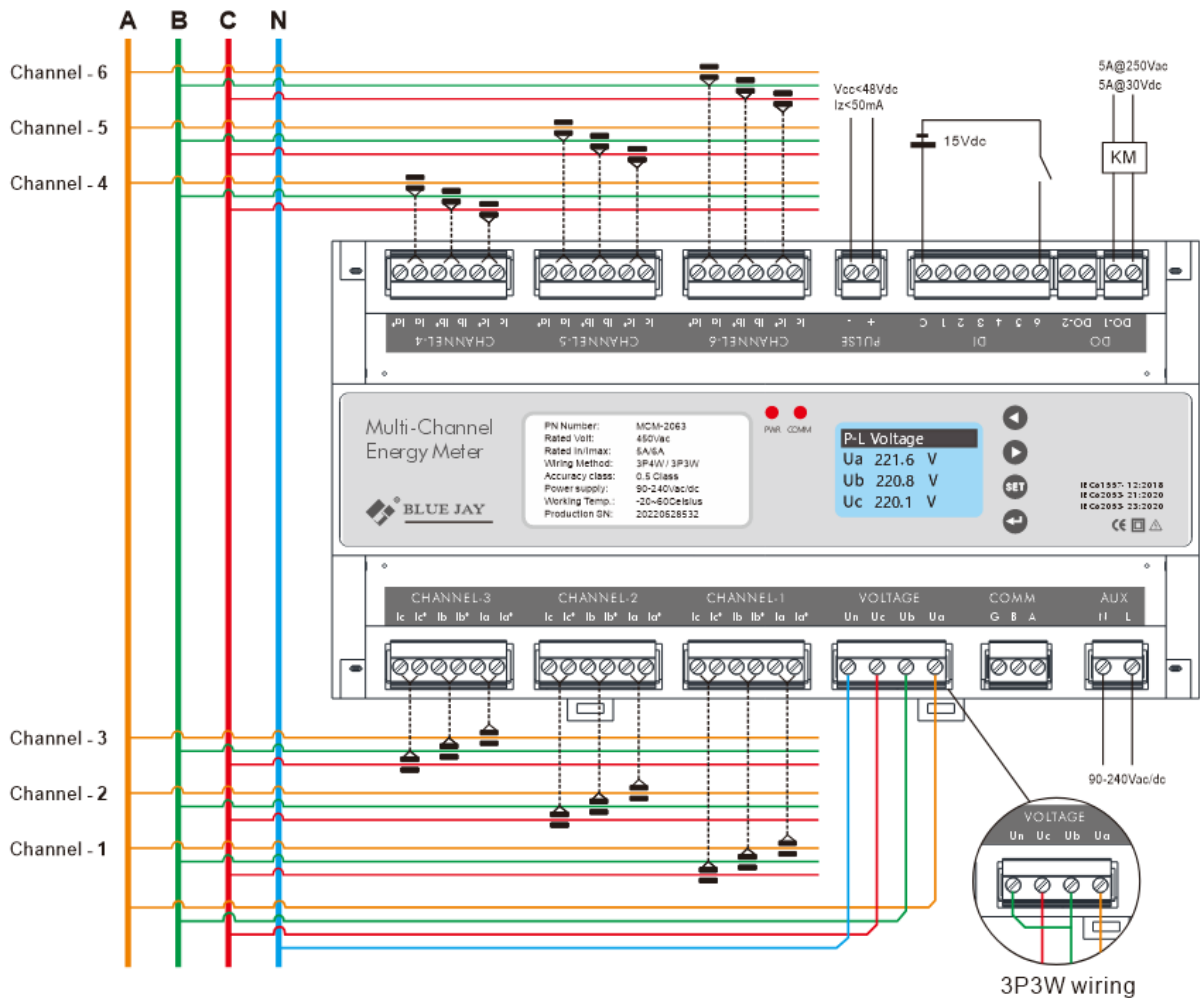

Note: In 3P3W wiring, Ub and Un need short external as drawing, or the display voltage will wrong.

IMPORTANT REMARK!

If power = -0.01 is shown for any of the phases and voltage and current are not zero for this phase, check out following points:

- Assure that A, B and C phases coincide in voltage and current.
- Correct polarity? Reverse the current transformer placed at this phase.

Typical wiring- 1P2W (max 18 channels)

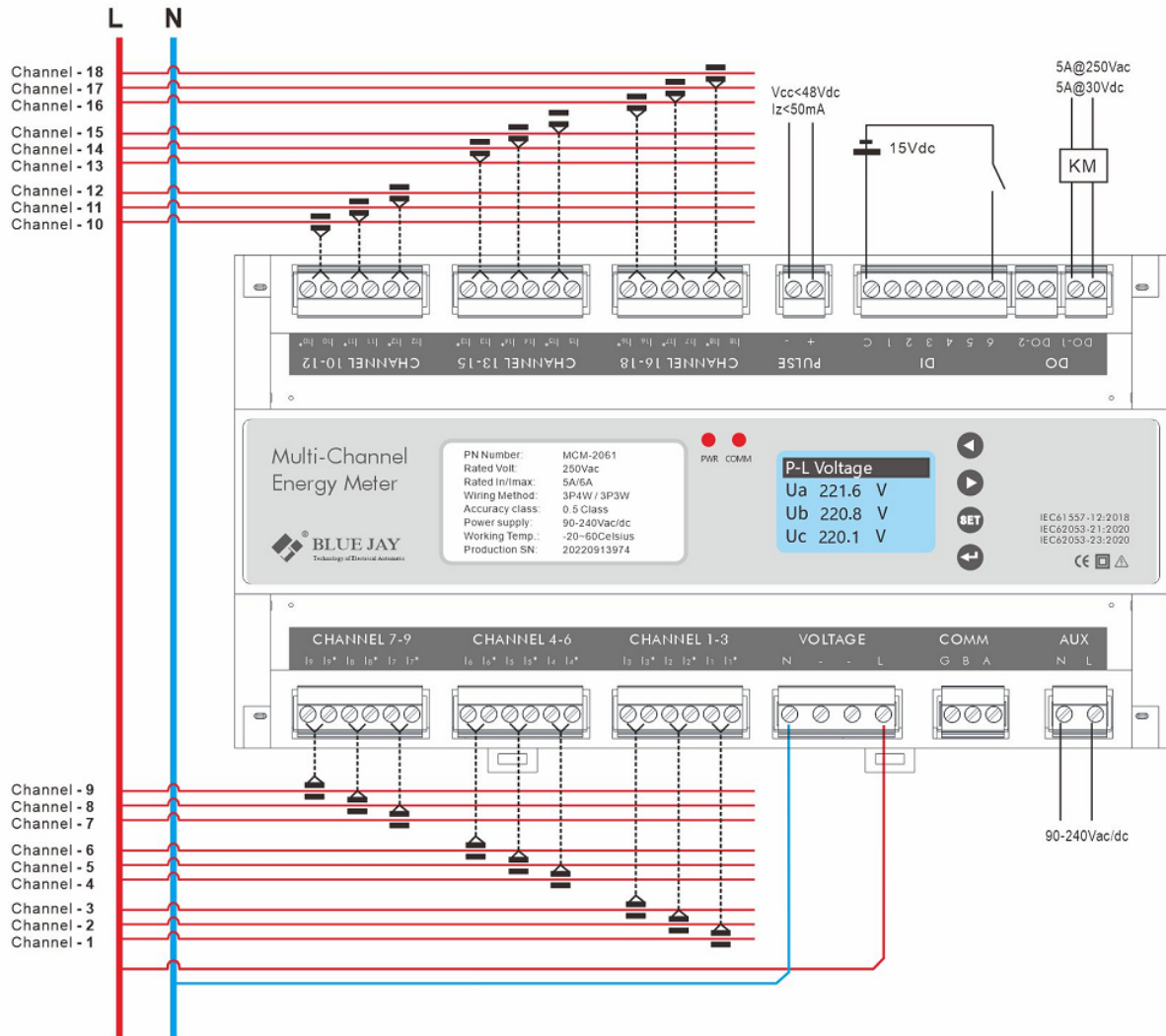

Notes:

1. DI port internal feed 15Vdc power, Common terminal is positive pin.
2. AUX can connect from feeder busbar.

5. SCREEN DISPLAY

5.1. - Panel Diagram

Energom-1000 optional LCD screen module, connect to RS485 wire to Energom body "DISPLAY" pin, provide electrical data display and on-site configuration.

Note: If your Energom do not have external display unit, please skip chapter 5 and chapter 6, and use RS485 port for operation.

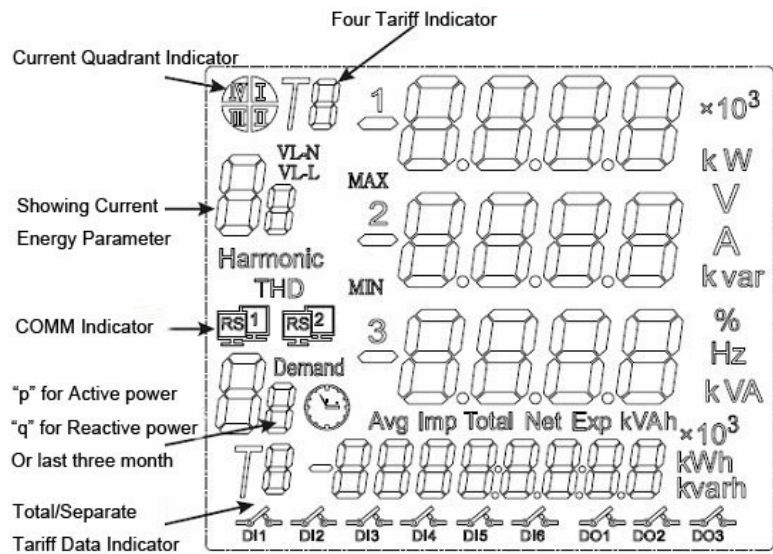

5.2.- Display unit connection

Display unit shape and size are same as 194 series power meter. need 85~265VAC/DC AUX power, RS-485 cabling must be carried out with a meshed screen cable (minimum 3 wire), diameter of not less than 0.5mm², with a maximum distance of 50m between the Energom-1000 and the display unit

This unit is to be mounted on panel (cut-out 91+0.8 x 91+0.8 mm). Keep all connections into the cabinet.

Note that with the instrument powered on, the terminals could be dangerous to touch and cover opening actions or elements removal may allow accessing dangerous parts. Therefore, the instrument must not be used until this is completely installed.

size of diplay unit

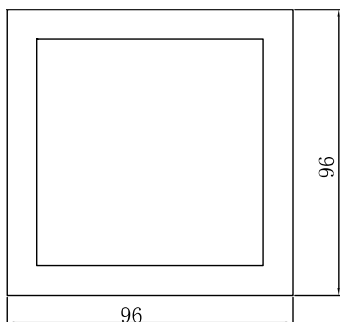

Front view

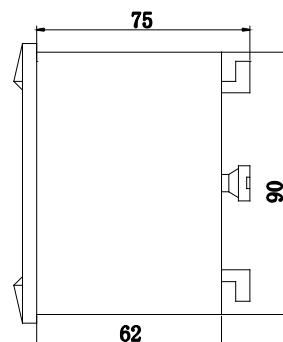



Side view

6. - OPERATION MODE

When the EnergoM-1000 and display unit are powered up, the entire symbol will be on, and the meter starts to self- test. After some seconds, the meter is ready for operation and shows one of the available screens.



Parameters on display can be switched by pressing key  or  LCD shown on screen at any moment

When the key  is pressed, the screen CURRENT values of each phase are now showing.

Pressing again the key , the screen will show the following parameters successively.

In setting menu, pressing key  move the setting cursor to left;

Pressing  can enter the number 0 ~ 9.





This key named "SET" key, pressing it can open the programming menu and return to previous menu.



This key named "Enter" key, pressing this key you can exit it with saving any modification that you might have done, in menu operation press "Enter" key, and user can go to the next menu.

Note:

Press key  or  in normal standby status, and the meter will show different data in main screen:

In the menu set mode, when changes the parameter and exit setting, the meter will ask to "SAVE",

press  *exit without saving*

press  *save and exit.*

Screen 1: Displays the three phase voltage U_a , U_b , U_c ;
As shown: $U_a = 380.0V$; $U_b = 380.0V$; $U_c = 380.0V$;

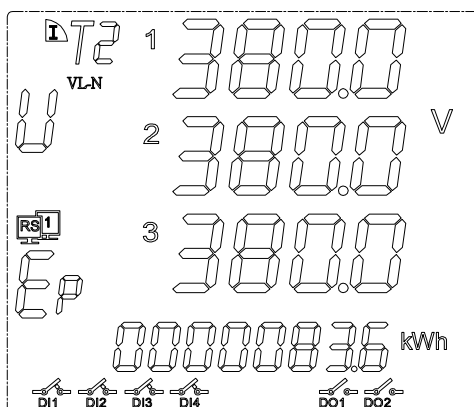

In the bottom character “Ep” show **total active energy** is 83.6KWh.

In other display area region show the system information:

DI1, DI2, DI3, DI4 in the close state;

DO1, DO2 in the open state;

Communication transceiver normal;

Note: Detail information for each symbol, please refer **chapter 5**, following sections as same

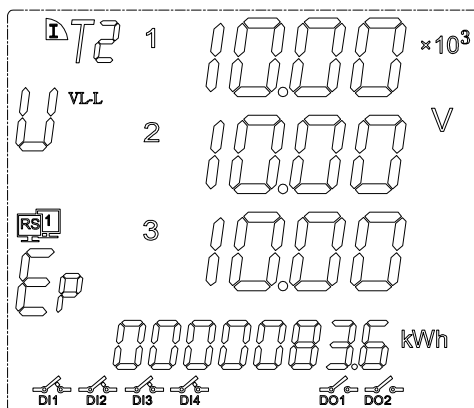

Note: in the high voltage measurement, $X10^3$ mean the showing voltage value multiplied by 1000, in the screen diagram mean the voltage is $10 \times 1,000 = 10,000$ volt

Screen 2: Display the three-phase current I_a , I_b , I_c .

In the bottom **Ep** shows **total negative active energy**.

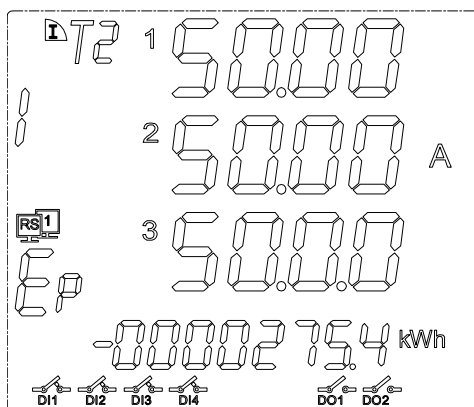

Screen 3: Display the total active power, total reactive power, and total factor.
In the bottom "**Eq**" shows **total active energy**.

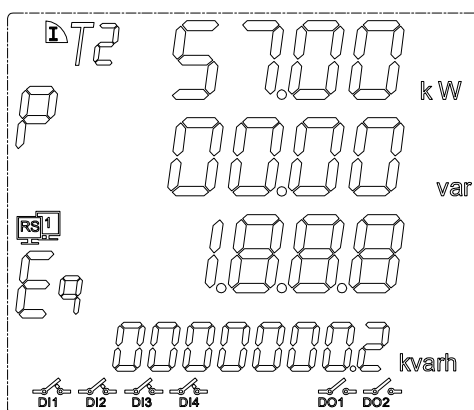

Screen 4: Display the frequency of a phase.
In the bottom "**Eq**" shows **total negative reactive energy**.

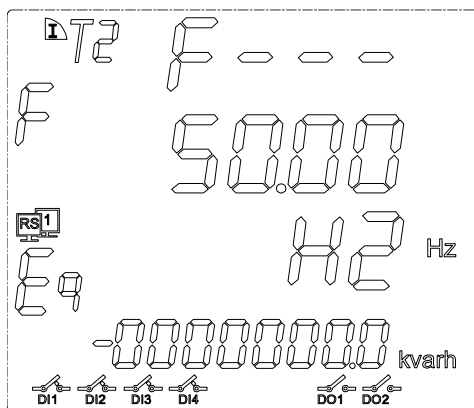

Screen 5: Display independent active phase. (only Three-phase 4 wire type)

In the bottom **Ep** shows **total active energy**

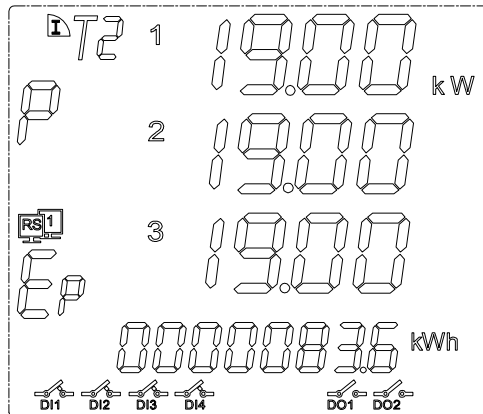

Screen 6: Display independent reactive phase. (only Three-phase 4 wire type)

In the bottom **Ep** shows **total negative active energy**.

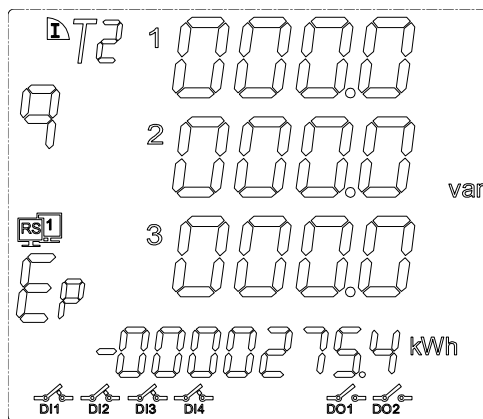

Screen 7: Display independent apparent phase. (only Three-phase 4 wire type)

In the bottom "**Eq**" shows **total active energy**.

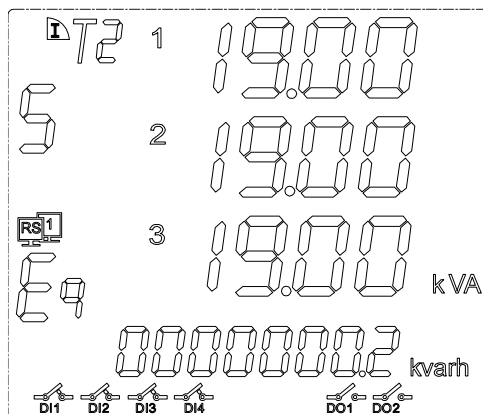

Screen 8: Display independent power factor. (only Three-phase 4 wire type)

In the bottom “Eq” shows **total negative reactive energy**.

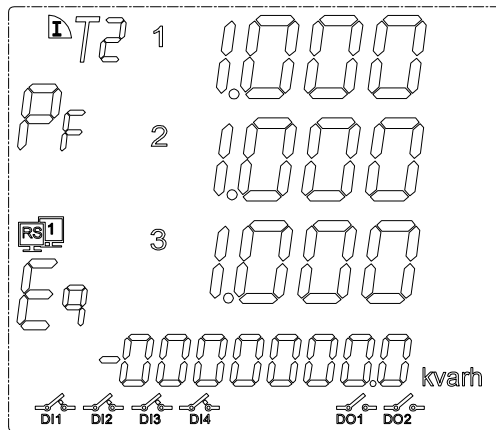



Screen 9: Display the 4 tariff energy data.

In the **top screen** “T1”~”T4” indicate current showing tariff.
In diagram show tariff_2

- E0~E3 indicate the last three month
- E0: Three month total energy data
- E1: Current month energy
- E2: Last month energy
- E3: Month before last month energy

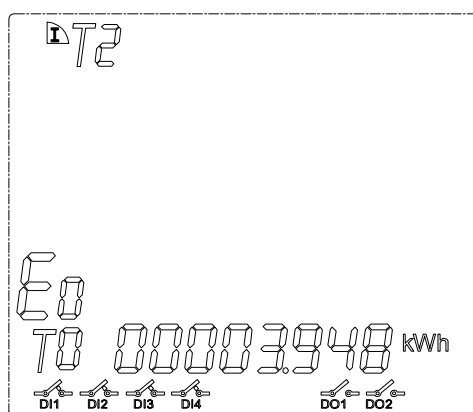
In the **bottom screen** “T1”~”T4” indicate the energy sum data in each tariff.



Note: Press key “” can switch show other energy data

Screen 10: Display maximum power demand.

Notes: use slip method, slip interval 1 minute, total of 15 minutes

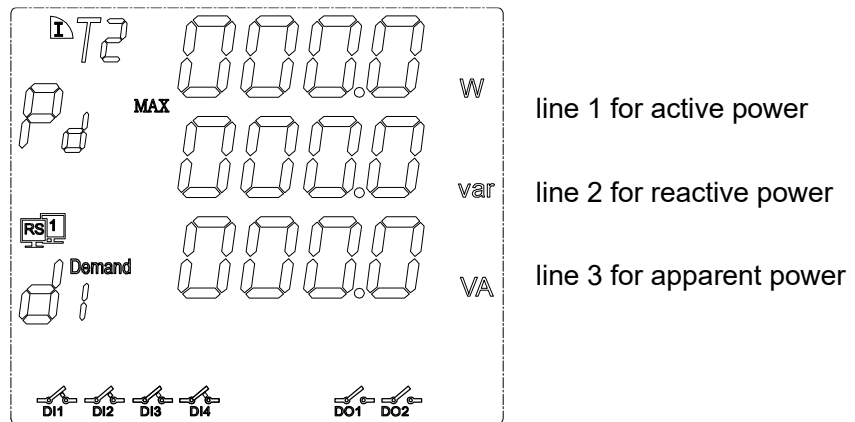

The lower left corner symbol "d1" mean display the current month's max demand power
"d2" for last month max demand power
"d3" for the month before last month max demand power

Screen 11: Display real-time clock,

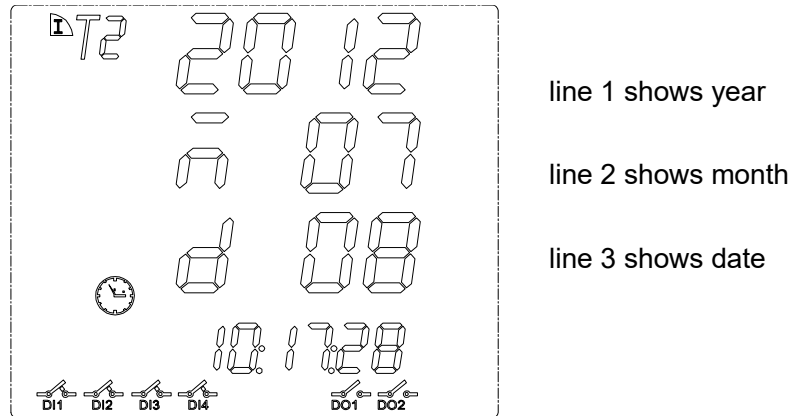

In the bottom line shows: Hour, minute and second.

Screen 12: Display voltage deviation

show three phase voltage deviation, unit %

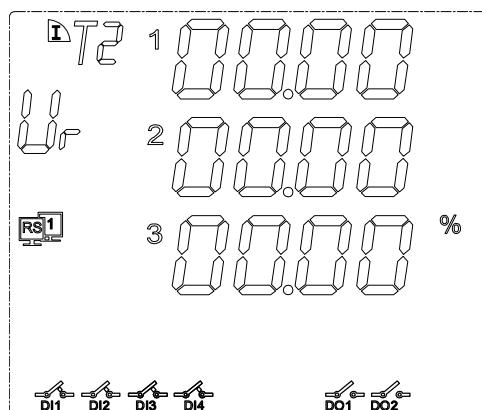

Screen 13: Display voltage deviation, unit %

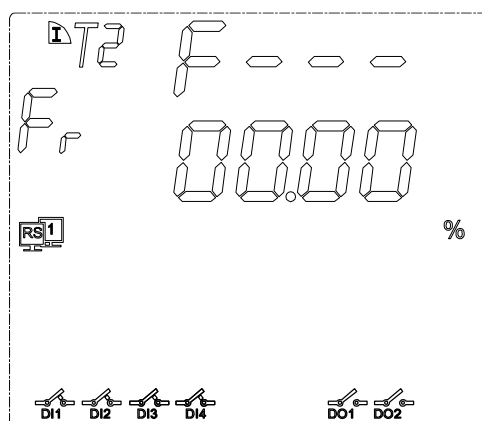

Screen 14: Display the voltage unbalance

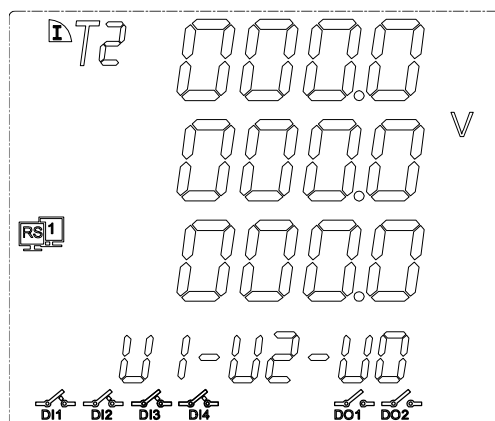

line 1 for positive sequence voltage

line 2 for negative sequence voltage

line 3 for zero-sequence voltage

Screen 15: Display the current unbalance

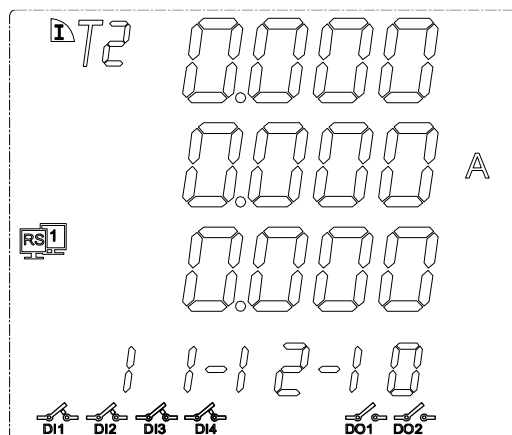

- line 1 for positive sequence current
- line 2 for negative sequence current
- line 3 for zero-sequence current

Screen 16: Display the voltage & current unbalance

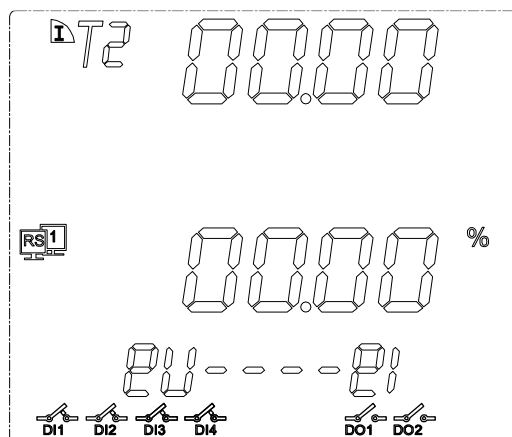

- line 1 show eU
- line 3 show ei

Screen 17: Display voltage THD%

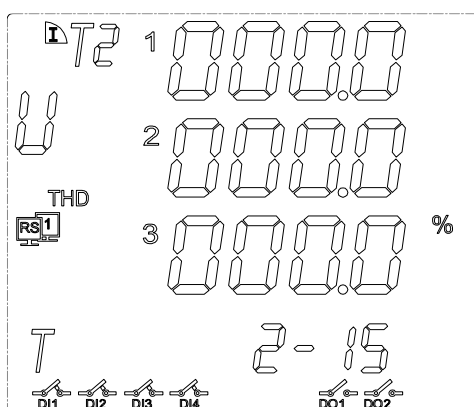

press  can show the 2~63* times voltage harmonic distortion
tOhd (total odd harmonic distortion)
tEhd (total even harmonic distortion)
tHFF (telephone harmonic form factor)
CF (crest factor).

Screen 18: Display current THD%

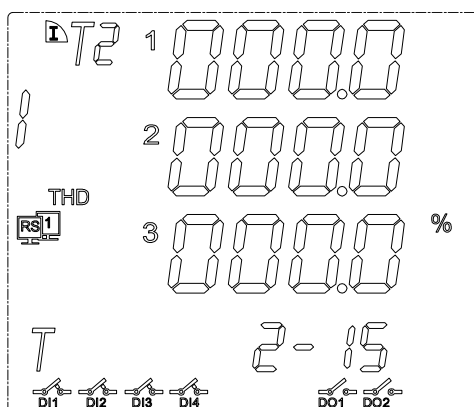

press  can show the 2~63* times harmonic distortion
tOhd (total odd harmonic distortion)
tEhd (total even harmonic distortion)
tHFF (telephone harmonic form factor)
CF (crest factor).

Screen 19: Display individual voltage harmonic data
press  can show the 2~63* times data.

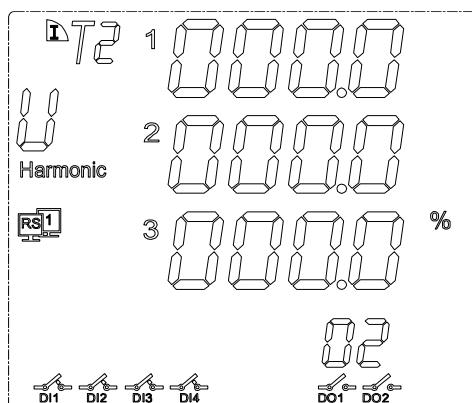

Screen 20: Display individual current harmonic data
press  can show the 2~63* times data.

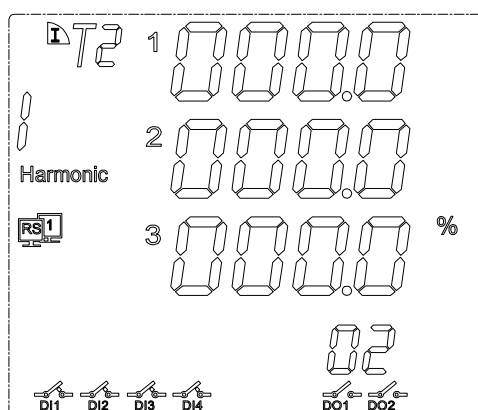

Notes: not all the device can display 63 time harmonic data, please contact team for more detail



7. - SETUP PROCEDURE



The SETUP procedure of the EnergoM-1000 is performed by means of several SETUP options. Once into the SETUP, use the keyboard to select different options and enter required variables:

7.1.- Input Password

A 4-figure password is required to be entered (in case that in case that the meter will work without permission.)

At normal display mode, press  to enter the programming mode, meter display

Meter display “  ”,
 ”,

Ask for the password. Press  to input the password number, from “0~9”. Press  to move the cursor . After password switch press  to confirm the input.

If password is correct, meter can enter next setting.

Notes: the default password is 0001 or 0023.



7.2. - Input Signal Selection

Press , return to level 1 menu.

In this section, user will set:.

1. Input net mode;
2. Voltage measure range;
3. Current measure range;
4. Voltage transformation ratio;
5. Current transformation ratio.

7.2.1.- Choice the input net mode

In level 1 menu, use  and  to choose item “-IN-”, and the meter shows like this:

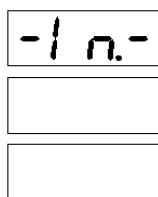

then press  , enter the level 2 menu, choose "LINE", meter shows:

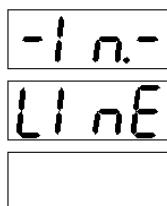

Then press  again, enter the level 3 menu.

Use  and  to select the right wiring mode, meter shows like this:

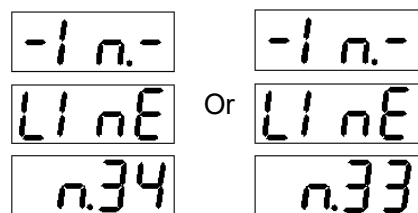



Note: Selecting the wiring mode must match with actual wiring, or the reading data will go wrong.

7.2.3.- Current measure range

In level 1 menu of "-IN-".

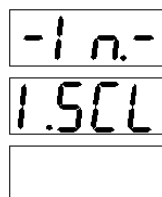
Choose "I.SCL", meter shows like this:



then press  , enter the level 3 menu, user can see the current range:

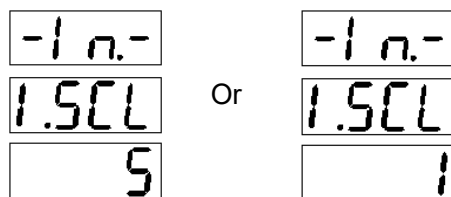

5A: Maximum measured value is 5A.

1A: Maximum measured value is 1A.

Note: Select a different range will affect the accuracy of measurements, if the accuracy is 0.5.

Select 1A range, means the minimum scale value is 0.005A (1 x 0.5%);

Select 5A range, means the minimum scale value is 0.025A (5 x 0.5%).

7.2.4- Voltage transformation ratio

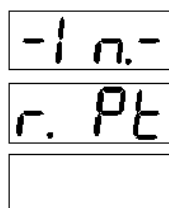

In level 1 menu of “-IN-”.

Choose item “r.PT” , meter shows like this:

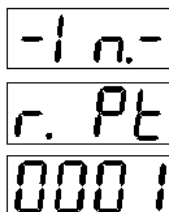

then press  , enter the level 3 menu, allowing us to set the current transformer.



Press  to input the number, from “0~9”. Press  to move the cursor. After password switch press  to confirm the input, value is 1~9999.

Note: The input values represent the voltage transformer (primary side voltage) / (secondary side voltage).

Secondary side voltage is 100V or 380V; user set it at section **7.2.2**

7.2.5. - Current transformation ratio

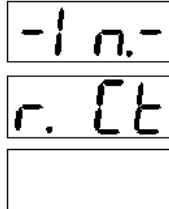

In level 1 menu of “-IN-”.

Choose the item “r.CT”, meter shows like this:

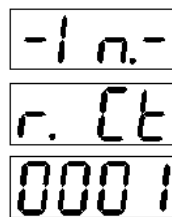

then press  , enter the level 3 menu, allowing us to set the current transformer.



Press  to input the number, from “0~9”. Press  to move the cursor. After password switch press  to confirm the input, value is 1~9999.

Note: The input values represent the current transformer (primary side voltage) / (secondary side current) .

Secondary side current is 1A or 5A, user set it at section **7.2.3**

7.3. - Communication Preferences

Press  , return to level 1 menu.

In this section, user will set:

1. Meter communication address;
2. Baud rate;
3. Communication format.

Note: Not all the meter have communication function, please make sure your purchase meter first, if no communication mode, you can skip this section.

7.3.1. - Meter communication address setting



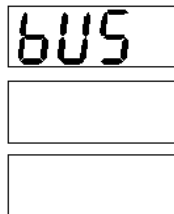

One or some EnergoM-1000 can be connected to a P.C. With this system we can get all the parameters in one central point of reading. device has a serial RS-485 output. If we connect more than one device to the same communication line (RS-485), we have to assign to each of them a different code or direction (from 1 to 247), since the P.C. needs the identification of every measuring point.

In level 1 menu, choose the item "bus", the meter shows like this:

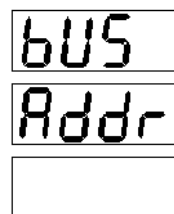

Then press  , enter the level 2 menu, choose the item "Addr", the meter shows like this:





Press  to input  the number, from "0~9". Press  to move the cursor. After password, press  to confirm the input, value is 1~9999.

7.3.2.- Communication Baud rate setting

In level 1 menu of “bus”.

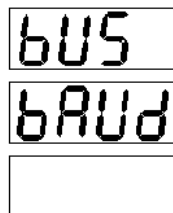
Choose item “BAUD”, and the meter shows like this:



Then press  , enter the level 3 menu, allowing us to set the Baud rate 2400, 4800 or 9600.

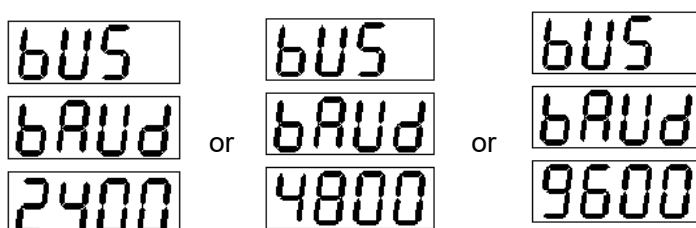

7.3.3.- Choose communication format

In level 1 menu of “bus”.

Choose item “data”, and the meter shows like this:

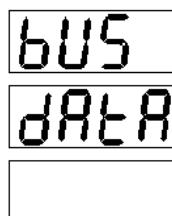

Then press  , enter the level 3 menu, allowing us to set the communication data format.
(Factory setting n.8.1)

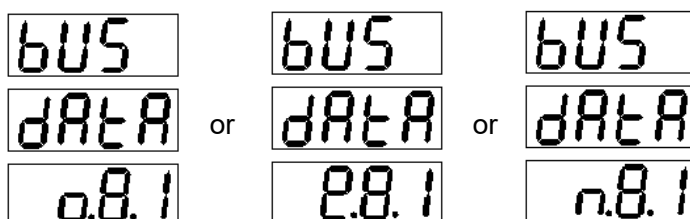

7.4. - Digital Output Setting



Press  , return to level 1 menu.

In this section, user will set:

1. Digital output type;
2. Output delay;
3. Choose the electrical parameter;
4. Set the alarm value
5. Set the hysteresis value

Note: If the meter have more than one channel digital output, you can set the DO-2 as the following step, please select the appropriate output settings in the level 1 menu.

7.4.1. - Output type

In level 1 menu, use  and  to choose item "DO-1", and the meter shows like this:

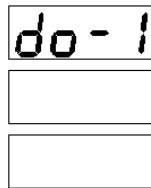

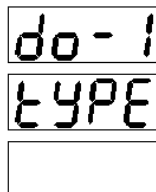

do-1

then press  , enter the level 2 menu, choose "TYPE". The meter shows:



do-1
TYPE

then press  again, enter the level 3 menu.

Use  and  to select the output type, meter shows like this:

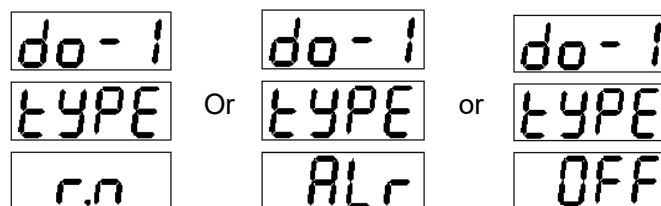

do-1 do-1 do-1
TYPE Or TYPE or TYPE
r.n ALr OFF

r.n: Mean remote control mode, there have *pulse* and *level* output mode, more detail refer chapter 7.4.2.

Host inquiry:

01	05	00 01	FF 00	DD FA
Address	Code	Relay address	Relay value (FF00:close; 0000: open)	CRC

Slave answer

01	05	00 01	FF 00	DD FA
Address	Code	Relay address	Relay value (FF00:close; 0000: open)	CRC

RS485 communication please refer to RS485 protocol document.

ALr: Mean directly alarm mode

OFF: Mean the relay will not work

7.4.2. - Set output delay

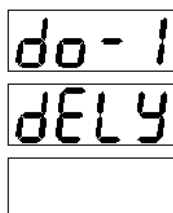

In level 1 menu of “DO-1”.

Choose item “DELY”, and the meter shows like this:

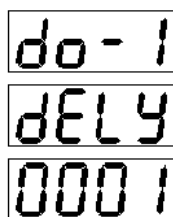

Then press  , enter the level 3 menu, user can set the delay value:



Press  to input the number, from “0~9”. Press  to move the cursor. After password switch press  to confirm the input, value is 1~9999. **(Default 0010)**

Note: The setting of relay value is indicating the width pulse output; value “0000” is for level output. The setting value resolution is 100ms, which means “0001” is 100ms, “9999” means 999.9s. **0 for level output, 1~9999 for pulse output**

7.4.3. - Choose the electrical parameter

In level 1 menu of “DO-1”.

Choose item “PARA”, meter shows like this:

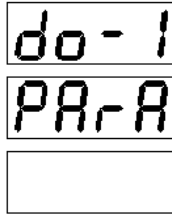

then press  , enter the level 3 menu, user can choose the output parameter:

Note: There are two alarm mode, indicate with “XX-H” and “XX-L”,

“XX-H” mean the rising edge alarm;

“XX-L” mean the falling edge alarm;

Example: “IA-H” mean when the A-phase current is rising to a certain value then output alarm.
“I3-H” mean when one phase of A, B, C phase current is rising to a certain value then output alarm.
“PS-L” mean when Three-phase total power is falling to a certain value then output alarm.

7.4.4. - Set the alarm value

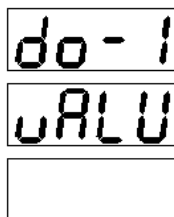

In level 1 menu of “DO-1”.

Choose item “VALU”; meter shows like this:

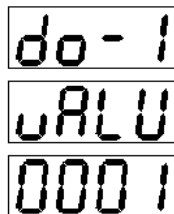

then press  , enter the level 3 menu, user can set the alarm value:



Press  to input the number, from “0~9”. Press  to move the cursor. After password switch press  to confirm the input, value is 1~9999. **(Default 5500)**

Note: Alarm value is about the secondary side value (such as AC100V, AC5A).

Voltage unit is 0.1V;

Current unit is 0.001A;

Active power unit is 0.1W;

Reactive power unit is 0.1VAR;

Power factor Is 0.001;

Frequency 0.01HZ;

7.4.5. - Set the hysteresis value

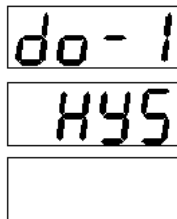

In level 1 menu of "DO-1".

Choose item "HYS", meter shows like this:

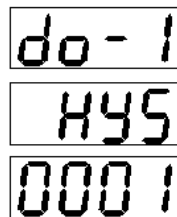

then press  , enter the level 3 menu, and user can set the alarm value:



Press  to input the number, from "0~9". Press  to move the cursor. After password switch press  to confirm the input, value is 1~9999. **(Default 0050)**

Hysteresis value is for cancel alarm status

Formula: $X=A \times Y$

A for alarm value(rising edge / falling edge)

Y for Hysteresis value

Only the difference between DO setting parameter value and real-time monitor value is greater than value **X** that can cancel the alarm



Example: Alarm value 3.700A; hysteresis value 0.03; Rising edge alarm; Measured value is 3.700A then relay action, output alarm; When measured value is bellow $3.700 - 3.700 \times 0.03 = 3.589A$, the alarm will be cancel.

7.5. - Time and Date Setting

Press , return to level 1 menu.

In this section, user will set the meter system time, which will affect the function of Muti-tariff:

7.5.1. - Set year

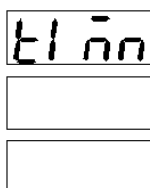

In level 1 menu, use  and  to choose item "TIME", meter shows like this:

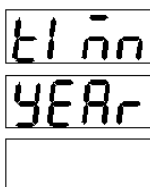

then press , enter the level 2 menu; choose "YEAR", meter show:



then press  again, enter the level 3 menu.

Use  and  to select the year, setting value from 00-99:



7.5.2. - Set month

In level 1 menu of "TIME".

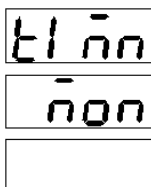
Choose item "MON", meter shows like this:



then press  again, enter the level 3 menu.

Use  and  to select the month, with setting value from 1-12:



7.5.3. - Set week day

In level 1 menu of "TIME".

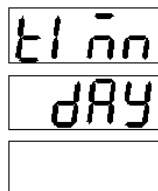
Choose item "DAY", meter shows like this:



then press  again, enter the level 3 menu.

Use  and  to select the day, with setting value from 1-31:



7.5.4. - Set date

In level 1 menu of "TIME".

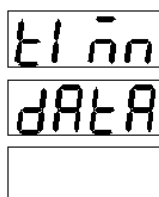
Choose item "DATE", meter shows like this:



then press  again, enter the level 3 menu.

Use  and  to select the week day, with setting value from 1-7:



7.5.5. - Set hour

In level 1 menu of "TIME".

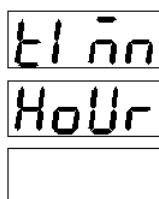
Choose item "HOURL", meter shows like this:



then press  again, enter the level 3 menu.

Use  and  to select the hour, setting value from 00-23:



7.5.6. - Set minute

In level 1 menu of "TIME".

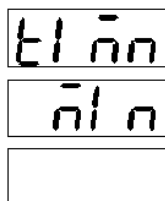
Choose item "MIN", meter shows like this:



then press  again, enter the level 3 menu.

Use  and  to select the minute, with setting value from 00-59:



7.5.7. - Set second

In level 1 menu of "TIME".

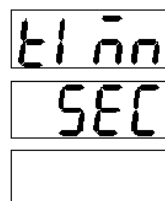
Choose item "SEC", meter shows like this:



then press  again, enter the level 3 menu.

Use  and  to select the second, setting value from 00-59:

7.5.8. - Set billing date

In level 1 menu of "TIME".

Choose item "E.DAY", meter shows like this:

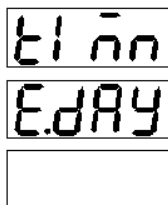

then press  again, enter the level 3 menu. Meter will show:

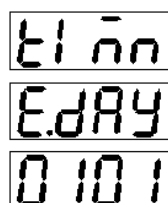

Use  and  to select the billing date:

Note: Default value is 0101, mean the billing date is At 1:00 on the 1st of each month.



Date : time

So the setting value max is 3123, which means each month 31st, 23:00

7.6. - Muti-tariff Setting



Press , return to level 1 menu.

In this section, user will set:

1. Billing segment setting;
2. Ttariff setting

Note: EnergoM contains 12 billing segments, with the billing segment 1 setting method in this manual.

7.6.1. - Set the billing time of segment 1

In level 1 menu, use  nd  o choose item "S.EG1", and the meter shows like this:

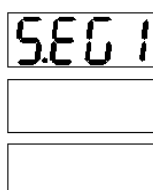

Then press  , enter the level 2 menu, choose “TIME”. The meter shows:

S.EG 1
E1 n n

Then press  again, entering the level 3 menu.

S.EG 1
E1 n n
0000

Use  and  to select the billing date.

Note: Default value is 0000, which means the billing date is at 00:00 on each day.

0000
min : sec

Segment 1 is for the multi-tariff starting time!!

7.6.2. - Choose the segment 1 billing tariff

Note:

EnergOM provides 3 months of energy data; use “**Sharp**” “**Peak**” “**Flat**” “**Valley**” (T1~T4) to calibrate the total energy data. Users can get monthly energy data from panel display or RS485(RS485 data refer to **Communication protocol**), and calculate their energy cost. .

You can set up 12 billing segment in one day. The segment 1 setting steps are as follows, and other segment setting method is the same.

In level 1 menu of “S.EG1”.

Choose item “E.Mod”, meter shows like this:

S.EG 1
E.nod



then press , enter the level 3 menu, user can choose the billing mod:

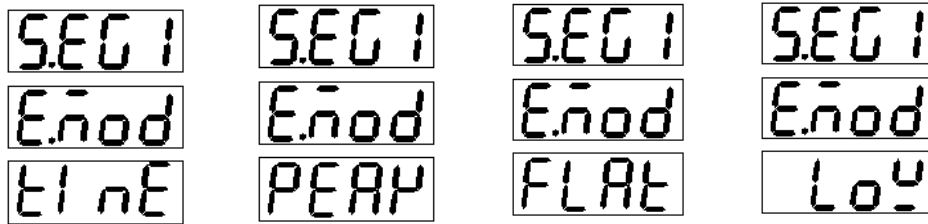

Note: Above mean: Sharp, Peak, Flat, Valley.



7.7. - System Setting

Press , return to level 1 menu.

In this section, user will set:

1. Backlight time of the LCD;
2. Clear energy counters;
3. Set display mode;
4. Change the password

7.7.1. - Set the LCD backlight time

In level 1 menu, use  and  to choose item "SYS", meter shows like this:

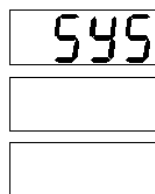

then press , enter the level 2 menu, choose "LCd.t", meter show:

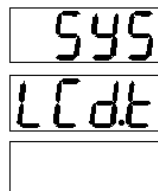

then press  again, enter the level 3 menu, Use  and  to select the value

Note: Minimum step is 1 minute, 0005 for 5 minutes, which means if not any operation in 5 minutes, the backlight will turn off

Set value > 1000, the backlight always on;
Set value = 0000, the backlight always off.

7.7.2. - Clear energy counters

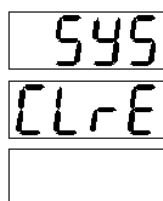

In level 1 menu of "SYS".

Choose item "CLr.E", meter shows like this:

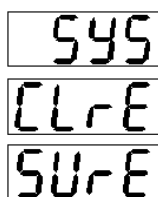

then press  again to confirm clear all the energy data, meter display:



And then press  again, to save the operation and exit.
Press  without save and exit.

7.7.3. - Set display mode

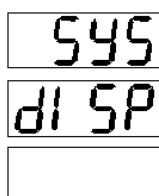

In level 1 menu of "SYS".

Choose item "dISP", meter shows like this:

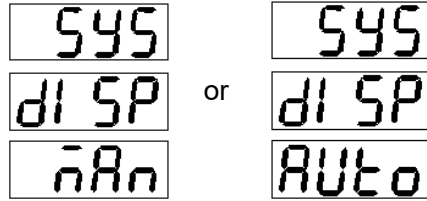

then press , enter the level 3 menu, user can choose the display mode:







Note: Man means the screen display will change by press  and .
Auto means the screen display will change in every 10 sec.

7.7.4. - Change the password

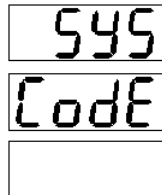
In level 1 menu of “SYS”.

Choose item “CodE”, meter shows like this:



then press  again, enter the level 3 menu.
Use  and  to input the new password:

Note:

7.8. – Menu Structure

level 1	Level 2	Level 3	Description
(System setting) SYS	(LCD backlight time) LCd.t	0000~1000	Factory default is 0005
	(Clear energy counters) CLr.E		Unrecoverable for Clear data
	(Display mode) dISP	Manual or Automatic	Factory default is manual
	(Change the password) CodE	0000~9999	Default is 0001
(Signal input) - IN-	(Net) Lin.e	N.3.4, N.3.3, N.1	Select the input signal network measurement
	(Voltage Range) U.SCL	100V, 220V, 380V	Select the range of measured voltage signal

	(Current Range) I.SCL	5A and 1A	Select the range of measured current signal
	(Voltage transformation ratio) R.PT	1-9999	Setting voltage signal transformation ratio = 1 / 2 scale
	(Current transformation ratio) R.CT	1-9999	Setting current signal transformation ratio = 1 / 2 scale
(Communication Parameters) bUS	(Address) ADDR	1-247	Instrument address range 1-247
	(Communication speed) BAUD	4800~9600	Default is 4800
	Protocol DATA	o.8.1; e.8.1; n.8.1	Factory default communication mode for the word (n.8.1)
(Digital output setting) DO-1 to DO-2	(Output type) TYPE	r.n, Alr, OFF	Default is Alr
	(Set output delay) DELY	0000~9999	Default is 0010
	Choose the electrical parameter PArA	I3-H, PS-H...U3-H	Default is I3-H
	(Set the alarm value) VALU	0000~9999	Default is 0050
	hysteresis value HYS	4800~9600	Default is 4800
(Time setting) TIME	(Year) YEAR	00~99	Default is 20XX
	(Month) MON	1~12	
	(Week day) DAY	1~7	
	(Date) DATE	1~31	
	(Hour) HOUR	00~23	
	(Minute) MIN	00~59	
	(Second) SEC	00~59	
	(Dilling date) E.dAy	0101~3123	Default is 0101

level 1	Level 2	Level 3	Level 4	Description
(Muti-tariff Setting) E.SEG	(Billing date of segment 1) S.EG1	Billing time of segment 1 (TIME)	Default 0000	
		Segment 1 billing tariff (E.Mod)	(Sharp) TinE (Peak) PEAK (Flat) FLAt (Valley) LOW	
	

	
	(Billing date of segment 12) S.EG12	Billing time of segment 12 (TIME)	Default 0000	
		Segment 1 billing tariff (E.Mod)	(Sharp) TinE (Peak) PEAK (Flat) FLAt (Valley) LOW	

Note: Not all EnergoM-1000 series have the complete menu settings, Please confirm your purchased power analyzer has the corresponding extension module. Without the module, the corresponding part of the menu is not valid.

7.9.- Display Character instructions

PRSS	User passwords	SYS	System parameter settings
Err0	Input error	TYPE	Choose Setted parameter
-1 n.-	User settings menu	PARA	The corresponding parameters
bUS	Communication settings menu	VALU	Set the alarm value
SCAL	Shows scal input value	LdI S	Show Low alarm setting
Pol t	Set the decimal point	HdI S	Show High alarm setting
dAtA	Communication parameter setting	Code	System password
Addr	Metter address setting	YEAR	Year
bAUD	Baud rate	non	Month
o.8.1	8 data bits, 1 stop bit, even parity	DAY	Week day
e.8.1	8 data bits, 1 stop bit, odd parity	DATE	Date
n.8.1	8 data bits, 1 stop bit, no parity	Hour	Hour
SUR E	Confirm the change	n1 n	Minute
USCL	Input voltage range selection	SEC	Second
ISCL	Input current range selection	E.SEG	Tariff segment
r. Ct	Set CT ratio	E.nod	Tariff
r. Pt	Set PT ratio	t1 nE	Sharp
L1 nE	Select phase	PEAK	Peak
do-1	Route 1 switch output settings	FLAT	Flat
do-2	Route 2 switch output settings	LoY	Valley
		E.DAY	Billing day

8.- COMMUNICATION INTERFACE

8.1.- Connection for the RS485 BUS

The composition of the RS-485 cabling must be carried out with a meshed screen cable (minimum 3 wire), diameter of not less than 0.5mm², with a maximum distance of 1,200 meters between the EnergoM-1000 and the master unit. This Bus may connect a maximum of 247 EnergoM-1000

Note:

1. Full range of EnergoM-1000 meter RS485 PIN number is 58,59,60
2. Due to product modifications or custom requirements, the interface pin place may be change.
For details, please refer to product label on the rear board

8.2.- MODBUS © protocol

Modbus RTU Frame Format:

Address code	1 BYTE	<i>Slave device address 1-247</i>
Function code	1 BYTE	<i>Indicates the function codes like read coils / inputs</i>
Data code	4 BYTE	<i>Starting address, high byte Starting address, low byte Number of registers, high byte Number of registers, low byte</i>
Error Check code	2 BYTE	<i>Cyclical Redundancy Check (CRC)</i>

MODBUS FUNCTIONS

Code:	Meaning:	Description:
FUNCTION 03	Reading of n Words	<i>This function permits to read all the electrical parameters of the BJ...series.</i>
FUNCTION 06	Write of Registers	<i>Write value in to the relevant register</i>

Notes: Default disable the write function, if want change configuration via RS485, please contact Team before your order.

8.3. - Register address table

8.3.1- Basic Power Data—Primary Side

Address	Data	Byte mode		Instruction
0x00	Ua	float	2	Channel_1 Phase to Line Voltage, Unit: V
0x02	Ub	float	2	
0x04	Uc	float	2	
0x06	Uab	float	2	Channel_1 Phase to Phase Voltage, Unit: V
0x08	Ubc	float	2	
0x0a	Uca	float	2	
0x0c	Ia	float	2	Channel_1 Three phase Current, Unit: A
0x0e	Ib	float	2	
0x10	Ic	float	2	
0x12	Pa	float	2	Channel_1 Individual phase active power, Unit: kW
0x14	Pb	float	2	
0x16	Pc	float	2	
0x18	$P\Sigma$	float	2	Channel_1 Total active power, Unit: kW
0x1a	Qa	float	2	Channel_1 Individual phase reactive power, Unit: kVar
0x1c	Qb	float	2	
0x1e	Qc	float	2	
0x20	$Q\Sigma$	float	2	Channel_1 Total reactive power, Unit: kVar
0x22	Sa	float	2	Channel_1 Individual apparent power, Unit: kVA
0x24	Sb	float	2	
0x26	Sc	float	2	
0x28	$S\Sigma$	float	2	Channel_1 Total apparent power, Unit: kVA
0x2a	PFa	float	2	Channel_1 Individual power factor, 0~1.000
0x2c	PFb	float	2	
0x2e	PFc	float	2	
0x30	$PF\Sigma$	float	2	Channel_1 Total power factor, 0~1.000
0x32	FR	float	2	Channel_1 Frequency, Unit:0.01Hz
0x34	Ep+	float	2	Channel_1 Positive active energy, Unit: kWh
0x36	Ep-	float	2	Channel_1 Negative active energy, Unit: kWh
0x38	Eq+	float	2	Channel_1 Positive reactive energy, Unit: kVarh
0x3a	Eq-	float	2	Channel_1 Negative reactive energy, Unit: kVarh
0x64~ 0x9e	/	float		Channel_2 Electrical data
0xc8~ 0x102	/	float		Channel_3 Electrical data

0x12c~ 0x166	/	float		Channel_4 Electrical data
0x190~ 0x1ca	/	float		Channel_5 Electrical data
0x1f4~ 0x22e	/	float		Channel_6 Electrical data

Float data follow IEEE754, float low bit first, high bit next. (CD AB)

8.3.2 - Basic Power Data—Secondary Side

Address	Data	Byte mode		Instruction
0x258	Ua	int	1	Channel_1 Phase to Line Voltage, Unit: 0.1V
0x259	Ub	int	1	
0x25a	Uc	int	1	
0x25b	Uab	int	1	Channel_1 Phase to Phase Voltage, Unit: 0.1V
0x25c	Ubc	int	1	
0x25d	Uca	int	1	
0x25e	Ia	int	1	Channel_1 Three phase Current, Unit: 0.001A
0x25f	Ib	int	1	
0x260	Ic	int	1	
0x261	Pa	int	1	Channel_1 Individual phase active power, Unit: W
0x262	Pb	int	1	
0x263	Pc	int	1	
0x264	$P\Sigma$	int	1	Channel_1 Total active power, Unit: W
0x265	Qa	int	1	Channel_1 Individual phase reactive power, Unit: Var
0x266	Qb	int	1	
0x267	Qc	int	1	
0x268	$Q\Sigma$	int	1	Channel_1 Total reactive power, Unit: Var
0x269	Sa	int	1	Channel_1 Individual phase apparent power, Unit: VA
0x26a	Sb	int	1	
0x26b	Sc	int	1	
0x26c	$S\Sigma$	int	1	Channel_1 Total apparent power, Unit: VA
0x26d	PFa	int	1	Channel_1 Individual power factor, 0~1.000
0x26e	PFb	int	1	
0x26f	PFc	int	1	
0x270	$PF\Sigma$	int	1	Channel_1 Total power factor, 0~1.000
0x271	FR	int	1	Channel_1 Frequency, Unit:0.01Hz
0x272	Ep+	int	2	Channel_1 Positive active energy, Unit: Wh
0x273	Ep-	int	2	Channel_1 Negative active energy, Unit: Wh
0x274	Eq+	int	2	Channel_1 Positive reactive power, Unit:Varh

0x275	Eq-	int	2	Channel_1 Negative reactive power, unit: Varh
0x2bc~ 0x2d9	/	int	/	Channel_2 electrical data
0x320~ 0x33d	/	int	/	Channel_3 electrical data
0x384~ 0x3a1	/	int	/	Channel_4 electrical data
0x3e8~ 0x405	/	int	/	Channel_5 electrical data
0x44c~ 0x469	/	int	/	Channel_6 electrical data

8.3.3- Meter status data

Address	Data	Byte mode		Instruction
0x4b0	DO	int	1	Digital output: Bit 0~1 show channel 1and channel 2 status 0 for open, 1 for closed
0x4b1	DI	int	1	Digital input: Bit 0~5 show channel 1 to channel 6 status 0 for open, 1 for closed

8.3.4- R/W parameters

Notes: If do not clear the EnergoM-1000 communication parameter, please shot the "RESET" pin and hole 5sec for recover the communication to default setting

Default setting:

address: 1

Baud ratio: 9600

Data format: n.8.1

Address	Item	Byte mode		Description
0x4ba	Port_1 COMM address	Int	1	Range: 1-247
0x4bb	Port_1 Baud Ratio	Int	1	0: 2400 1: 4800 2: 9600 3: 19200
0x4bc	Port_1 Data format	Int	1	0: n.8.1 1: o.8.1 2: e.8.1 3: n.8.2
0x4bd	Port_2 COMM address (for DISPLAY unit)	Int	1	<u>Disallowed</u> configuration when work with DISPLAY unit! or will may display error; If done some change, please shot the "RESET" for recover the fault setting
0x4be	Port_2 Baud Ratio (for DISPLAY unit)	Int	1	

0x4bf	Port_2 Data format (for DISPLAY unit)	Int	1	
0x4c0~0x4c3	/	Int	1	reversed
0x4c4	DO1 Mode	Int	1	0: Remote 1: Alarm 2: OFF
0x4c5	DO1 Act delay	Int	1	Alarm mode: 0.0-999.9sec Remote mode: 0: Level mode Other value: 0.1-999.9sec (Pulse width)
0x4c6	DO1 Alarm data	Int	1	0: UA upper alarm 1: UB upper alarm 2: UC upper alarm 3: UAB upper alarm 4: UBC upper alarm 5: UCA upper alarm 6: UA/UB/UC upper alarm 7: channel_1 IA upper alarm 8: channel_1 IB upper alarm 9: channel_1 IC upper alarm 10: channel_2 IA upper alarm 11: channel_2 IB upper alarm 12: channel_2 IC upper alarm 13: channel_3 IA upper alarm 14: channel_3 IB upper alarm 15: channel_3 IC upper alarm 16: channel_4 IA upper alarm 17: channel_4 IB upper alarm 18: channel_4 IC upper alarm 19: channel_5 IA upper alarm 20: channel_5 IB upper alarm 21: channel_5 IC upper alarm 22: channel_6 IA upper alarm 23: channel_6 IB upper alarm 24: channel_6 IC upper alarm 25: current upper alarm for any channel 26: PA upper alarm 27: PB upper alarm 28: PC upper alarm 29: total active power upper alarm 30: QA upper alarm 31: QB upper alarm 32: QC upper alarm 33: total reactive power upper alarm 34: SA upper alarm 35: SB upper alarm 36: SC upper alarm 37: total apparent power upper alarm 38: total power factor upper alarm 39: frequency upper alarm 40: DI1 close alarm 41: DI2 close alarm 42: DI3 close alarm 43: DI4 close alarm 44: DI5 close alarm

				45: DI6 close alarm 46: UA lower alarm 47: UB lower alarm 48: UC lower alarm 49: UAB lower alarm 50: UBC lower alarm 51: UCA lower alarm 52: UA/UB/UC lower alarm 53: channel_1 IA lower alarm 54: channel_1 IB lower alarm 55: channel_1 IC lower alarm 56: channel_2 IA lower alarm 57: channel_2 IB lower alarm 58: channel_2 IC lower alarm 59: channel_3 IA lower alarm 60: channel_3 IB lower alarm 61: channel_3 IC lower alarm 62: channel_4 IA lower alarm 63: channel_4 IB lower alarm 64: channel_4 IC lower alarm 65: channel_5 IA lower alarm 66: channel_5 IB lower alarm 67: channel_5 IC lower alarm 68: channel_6 IA lower alarm 69: channel_6 IB lower alarm 70: channel_6 IC lower alarm 71: current lower alarm for any channel 72: PA lower alarm 73: PB lower alarm 74: PC lower alarm 75: total active power lower alarm 76: QA lower alarm 77: QB lower alarm 78: QC lower alarm 79: total reactive power lower alarm 80: SA lower alarm 81: SB lower alarm 82: SC lower alarm 83: total apparent power lower alarm 84: total power factor lower alarm 85: frequency lower alarm 86: DI1 open alarm 87: DI2 open alarm 88: DI3 open alarm 89: DI4 open alarm 90: DI5 open alarm 91: DI6 open alarm
0x4c7	DO1 Alarm value	Int	1	Secondary side electrical value
0x4c8	DO1 HYS	Int	1	Hysteresis value
0x4c9	DO2 mode	Int	1	Same as DO1 port
0x4ca	DO2 Act delay	Int	1	
0x4cb	DO2 Alarm data	Int	1	
0x4cc	DO2 Alarm value	Int	1	
0x4cd	DO2 HYS	Int	1	

0x4ce~ -0x4d7	reversed	Int	1	/
0x4d8	input net mode	Int	1	0: 3P4W 1: 3P3W 2CT 2: 3P3W 3CT
0x4d9	Voltage measure range	Int	1	0: 100V 1: 380V
0x4da	Current measure range	Int	1	0: 1A 1: 5A
0x4db	Voltage transformation ratio	Int	1	1-9999
0x4dc	Channel_1 CT ratio	Int	1	1-9999
0x4dd	Channel_2 CT ratio	Int	1	1-9999
0x4de	Channel_3 CT ratio	Int	1	1-9999
0x4df	Channel_4 CT ratio	Int	1	1-9999
0x4e0	Channel_5 CT ratio	Int	1	1-9999
0x4e1	Channel_6 CT ratio	Int	1	1-9999
0x4e2~ 0x4ed	Channel_7~18 CT ratio	Int	1	1-9999 (only for single phase type)
0xbb8	Clear energy counter	Int	1	Send code: 0x0A0A,

Note:

1. Not all of the data above can be read by RS485, the reading address will be unsuccessful
2. The data can be read out depends on your multi-function meter model, please refer to the corresponding product manual before build your software.
3. Some software has different definitions of the start bit of register address, there will be offset, please add 1 for the right address. To get more info, please contact technical support
4. provide BOS1000 software for small measurement network and customer testing, it can connect max 32pcs of power meter, user can free to download this software

8.4.- Example

Host to Slave inquiry

Addr	Fun	Data Address (high)	Data Address (low)	Data Number (high)	Data number (low)	CRC16 (low)	CRC16 (high)
0CH	03H	00H	00H	00H	06H	C4H	D5H

PC user ask upload UA, UB, UC, IA, IB, IC

Slave to Host answer

Addr	Fun	Byte count	Data1 high	Data1 low	Data2 high	Data2 low	Data3 high	Data3 low
0CH	03H	0CH	03H	E8H	03H	E9H	03H	E8H
Data4 high	Data4 low	Data5 high	Data5 low	Data6 high	Data6 low	CRC16 low	CRC16 high	
13H	84H	13H	88H	13H	8AH	A6H	D6H	

Show the data:

UA=3E8H (100.0)

UB=3E9H (100.1)

UC=3E7H (99.9)

IA=1384H (4.996)

IB=1388H (5.000)

IC=138AH (5.002)

Notes:

1. User can write register data for meter testing and remote control the meter
2. When the write is unsuccessful, no return data from the slave, in this addition, user can send write inquiry again

9. - SAFETY CONSIDERATIONS



All installation specification described at the previous chapters named: **INSTALLATION AND STARTUP, INSTALLATION MODES and SPECIFICATIONS.**

Note that with the instrument powered on, the terminals could be dangerous to touching and cover opening actions or elements removal may allow accessing dangerous parts. This instrument is factory-shipped at proper operation condition.

10. - MAINTENANCE

The EnergoM-1000 does not require any special maintenance. No adjustment, maintenance or repairing action should be done when the instrument is open and powered on, should those actions are essential, high-qualified operators must perform them.

Before any adjustment, replacement, maintenance or repairing operation is carried out, the instrument must be disconnected from any power supply source.

When any protection failure is suspected to exist, the instrument must be immediately put out of service. The instrument's design allows a quick replacement in case of any failure.