



Acuvim-L Series Power Meter L-WEB User's Manual

ЭНЕРГОМЕТРИКА
www.energometrika.ru

Copyright © 2019 V1.00

This manual may not be altered or reproduced in whole or in part by any means without the expressed written consent of Energometrika.

The information contained in this document is believed to be accurate at the time of publication, however, Accuenergy assumes no responsibility for any errors which may appear here and reserves the right to make changes without notice. Please ask the local representative for latest product specifications before ordering.

Please read this manual carefully before installation, operation and maintenance of the AcuRev 1310 series meter. The following symbols in this manual are used to provide warning of danger or risk during the installation and operation of the meters.



Electric Shock Symbol: Carries information about procedures which must be followed to reduce the risk of electric shock and danger to personal health.



Safety Alert Symbol: Carries information about circumstances which if not considered may result in injury or death.

Prior to maintenance and repair, the equipment must be de-energized and grounded. All maintenance work must be performed by qualified, competent accredited professionals who have received formal training and have experience with high voltage and current devices. Accuenergy shall not be responsible or liable for any damages or injuries caused by improper meter installation and/or operation.

Table of Contents

1. Introduction to Ethernet.....	4
2. Functional Description of the Ethernet module	4
3. Appearance and Dimensions	5
4. Installation Method	6
5. Definition of RJ45	7
6. Initializing the Ethernet module	8
7. Cable.....	17
8. Connection method.....	18
8.1 Direct Connect to a Computer.....	18
8.2 Direct Connect to Router/Switch.....	21
9. Description of Modbus-TCP Protocol	22
9.1 Protocol	22
9.1.1 Data Frame Format.....	22
9.1.2 Modbus Application Header (MBAP Header) Field	22
9.1.3 Function Field	23
9.2 Format of communication	23
9.2.1 Explanation of frame	23
10. Web Interface Readings and Parameter Settings.....	28
10.1 User Access Login.....	28
10.2 Dashboard.....	29
10.3 Metering web page	30
Basic Metering:	30
Power & Energy:	31
Min/Max:.....	32
Harmonics:	33
Phase Angles:	34
Sequence:	35
I/O:.....	36

10.4 Status web page	37
Trend Log:.....	37
Energy:.....	39
Data Preview:	40
Data Log:.....	41
Alarm Log:.....	42
SOE Log:.....	42
PQ Event Log:.....	43
10.5 About	44
10.6 Settings web page	45
Meter.....	45
Communication	49
Network:.....	49
Email	51
Time/Date.....	54
Data Log.....	56
Post Channel.....	58
AcuCloud.....	63
BACnet/IP.....	65
SNMP	66
DNP	68
Management.....	72
Parameter Reset	72
Module Reboot	72
Change Password	73
SSH.....	73
Debug Diagnostic	73
Diagnostic File.....	74
Network Diagnostic.....	75
Module Firmware Update	77
Manual Update	77
Remote Update.....	78

1. Introduction to Ethernet

Ethernet was originally developed by Xerox and then further developed by DEC and Intel. This networking technology uses Carrier Sense Multiple Access with Collision Detection (CDSM/CD) protocol and provides transmission speeds up to 100Mbps.

Ethernet is not a network but more of a standard. It is the most current communication standard Local Area Network(LAN). This standard defines the type of cable that is used and the method of Signal Processing.

2. Functional Description of the Ethernet module

The L-WEB module supports the Modbus-TCP protocol. When connected to the Acuvim L series meter, it is a slave device that can only respond to queries. The default value for the Modbus Port is 502, however the user defined range is 2000~5999.

This module supports the SMTP protocol, which allows the user to send emails based on a specific time interval or when a triggered event occurs. It can send mail from encrypted servers and servers that use different SMTP ports.

The L-WEB module supports the HTTPS protocol, it is used as an HTTPS server where the default value of the protocol port is 443. Using the HTTPS protocol, the L-WEB can send post requests to both HTTP and HTTPS servers.

The following are all the protocols supported by the L-WEB module:

- Modbus TCP
- SNMP
- DNP 3.0
- SMTP, SNTP
- HTTP/HTTPS
- FTP
- sFTP
- BACnet

3. Appearance and Dimensions

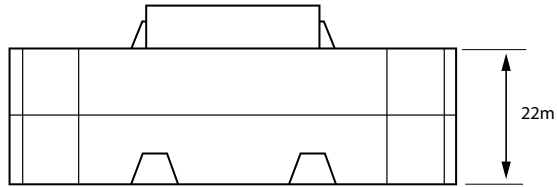

(Side View)

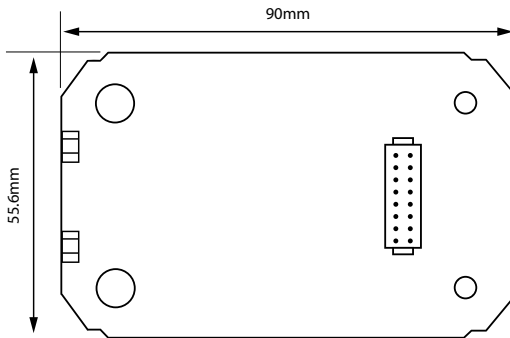

(Top View)

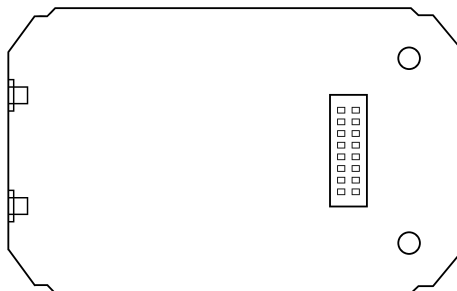

(Bottom View)

4. Installation Method

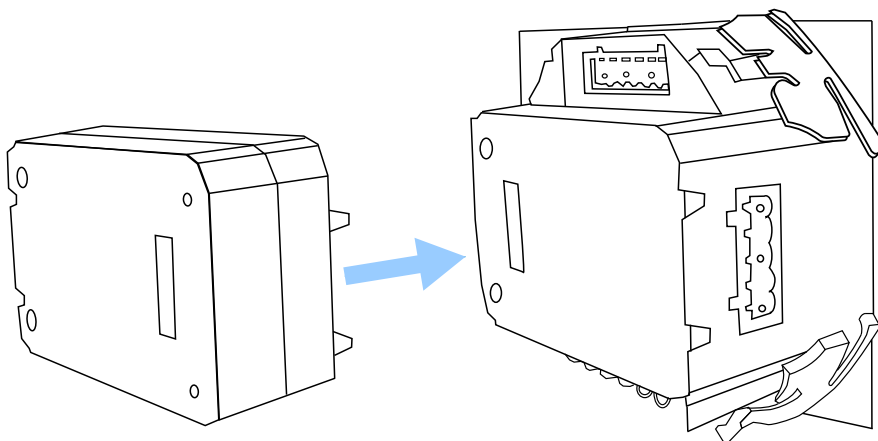

The L-WEB module is linked to the Acuvim L series meter by a communication plug. Other extended modules such as the IO modules can be linked to the Acuvim L series meter through the L-WEB module.

1. Remove cover from the back of the Acuvim L series meter which will expose the socket.
2. Insert the installation clips to the grooves in the Acuvim L series meter and then press the L-WEB module lightly to establish a linking between meter and module.
3. Tighten the installation screws.

NOTE: Installation with power to the meter is forbidden.

NOTE: If using extended I/O modules with L-WEB module, ensure that the L-WEB module is attached to the meter first followed by the I/O modules. If the L-WEB module is not connected first it will not be able to communicate with the Acuvim L meter.

5. Definition of RJ45

The L-WEB uses a standard RJ45 connector to access the Ethernet network. The mechanical and electrical characteristics of the connector are consistent with the requirements of IEC 603-7.

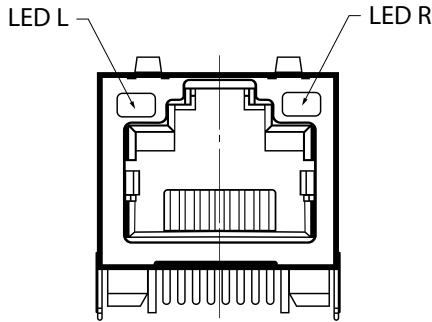

(Top View)

Script	ID	Content
1	TX+	Tranceive Data+
2	TX-	Tranceive Data-
3	RX+	Receive Data+
4	n/c	Not connected
5	n/c	Not connected
6	RX-	Receive Data-
7	n/c	Not connected
8	n/c	Not connected

LED_L (Yellow): Displays the speed status. When the LED is on it indicates 100Mbps, whiles an 'off' LED represents a speed of 10Mbps.

LED_R (Green): Displays the link and activity status. When the LED is 'on' it indicates the link status. When the LED is flashing it indicates that there is activity.

6. Initializing the Ethernet module

The default settings in the Acuvim L series meter are as followed:

DHCP: Manual

IP Address: 192.168.1.254

Subnet Mask: 255.255.255.0

Gateway: 192.168.1.1

Primary DNS Server: 8.8.8.8

Secondary DNS Server: 8.8.4.4

Modbus Port: 502

HTTP Port: 80

This information can be found by using the buttons from the meter display. The following is how to configure the Ethernet module settings from the display:

- Press the 'H' and 'V/A' buttons simultaneously on the Acuvim L series. Release the buttons and the meter will enter the meter selecting mode, as indicated by the flashing 'Meter' cursor.



- Press the 'P' or 'E' button to move the cursor to 'Setting'. Press 'V/A' button to enter the parameter setting mode. The device address page is the first page of the 'Setting' mode. It will show the Modbus address of the meter for a second before prompting for the password of the device. Press 'V/A' button to confirm password and enter the parameter setting page. Press the 'P' or 'E' button to move the cursor to 'NET' and press the 'V/A' button to enter the Ethernet module settings.

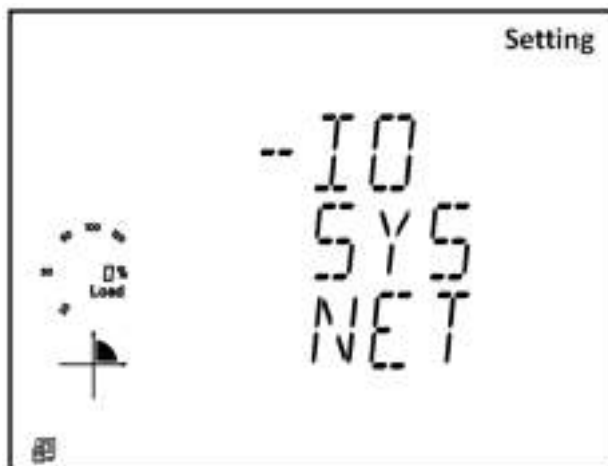
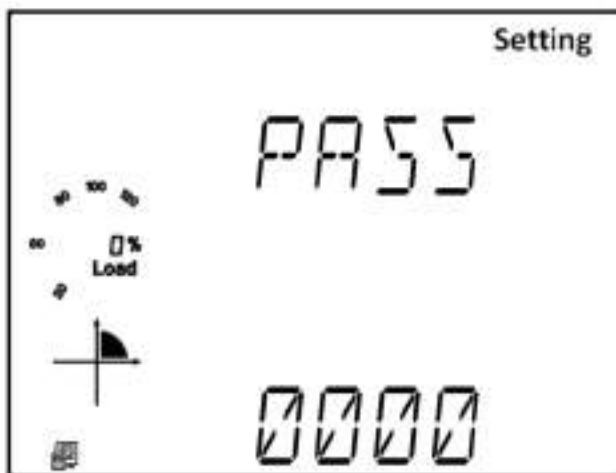

- The first page of the NET Settings will be the 'N1' setting page. This is the meters DHCP setting screen, and by default this is configured as Manual. Setting this configuration to Auto will allow the router to assign the meter with an IP address, while Manual will allow the user to configure the IP address.
 - Press the 'V/A' button to enter edit mode.
 - Press 'P' or 'E' to change the setting and press 'V/A' to confirm.

NOTE: If the DHCP is selected as Auto, the Ethernet module needs to be rebooted before it can be assigned with the new IP address.

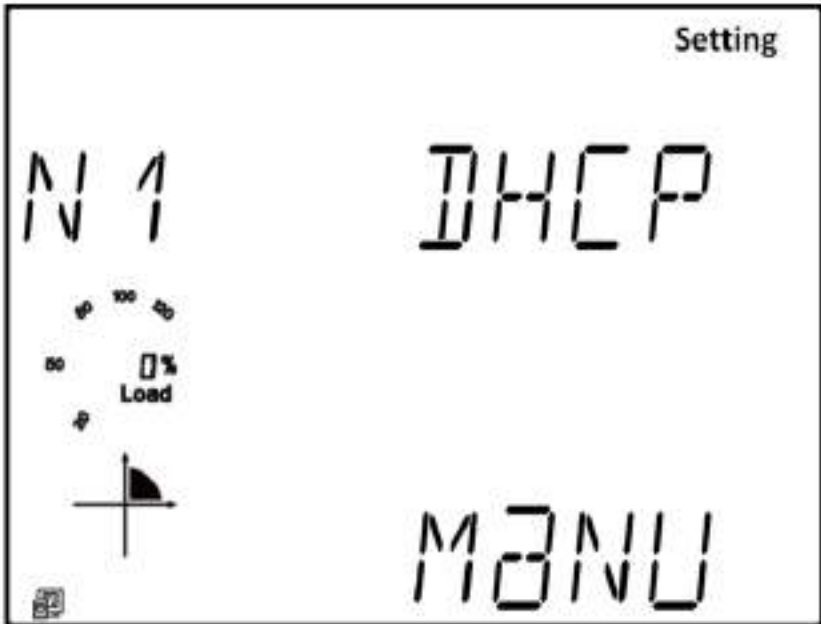

- Press 'E' to get to page 'N2', this is the **IP address** setting of the meter and will be the IP address to access the web interface of the module. Users can configured the IP address if the DHCP is configured as Manual.
- Press 'V/A' to configure the IP address. The cursor of the first digit will begin to flash.
- Press the 'H' button to scroll through the digits, press the 'P' or 'E' to change the value of the flashing cursor.
- Once the IP is configured users can press 'V/A' to confirm.

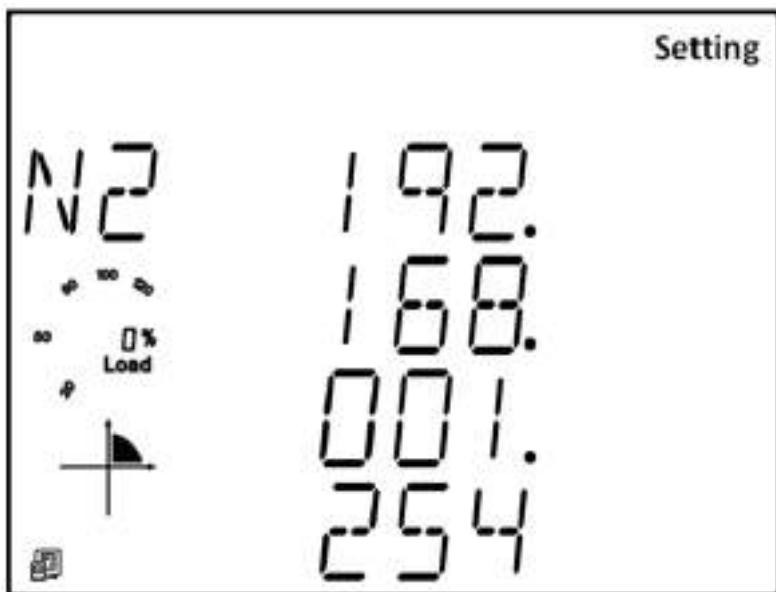

- Press 'E' to get to 'N3' page, this is the meters Submask setting.
 - Press 'V/A' to enter edit mode and configure the sub mask address. The cursor of the first digit will begin to flash.
 - Press the 'H' button to scroll through the digits, and press 'P' or 'E' to change the value of the flashing cursor.
 - Once the sub mask has the correct address press 'V/A' to confirm.

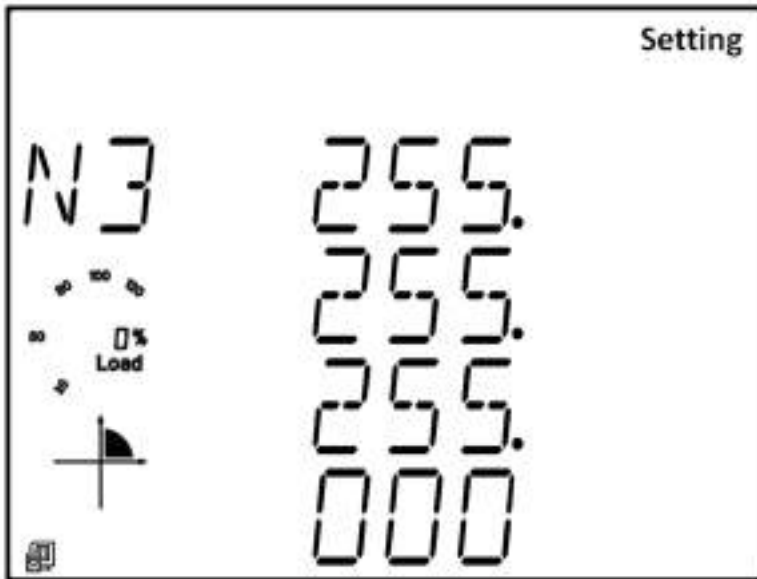

- Press 'E' to get to 'N4' page, this is the meters **Gateway** setting.
 - Press 'V/A' to enter edit mode and configure the gateway IP address. The cursor will begin to flash on the first digit.
 - Press the 'H' button to scroll through the digits, and then press the 'P' or 'E' to change the value of the flashing cursor.
 - Once the gateway is configured press 'V/A' to confirm.

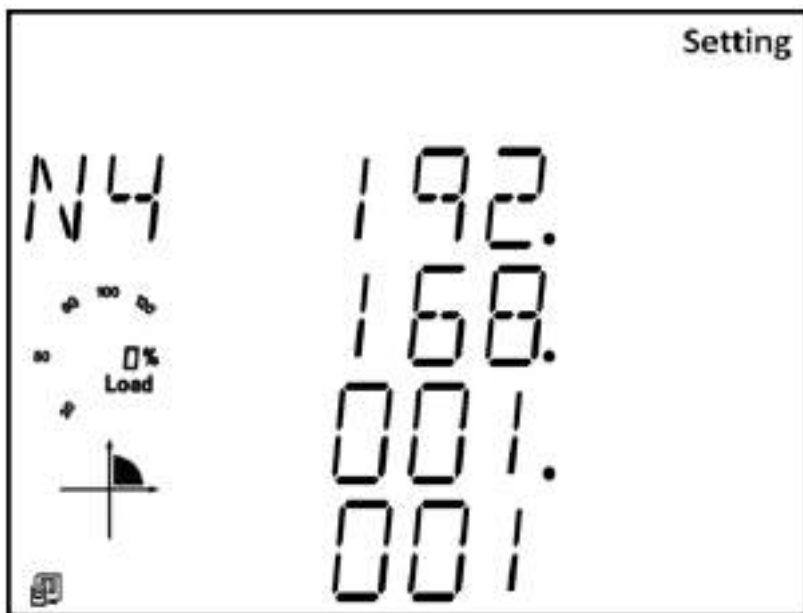

- Press 'E' to get to 'N5' page, this is the meters **Primary DNS Server** settings.
 - Press 'V/A' to enter edit mode and configure the DNS address, the cursor of the first digit will begin to flash.
 - Press the 'H' button to scroll through the digits.
 - Press the 'P' or 'E' to change the value of the flashing cursor.
 - Once the primary DNS server address is entered press 'V/A' to confirm.

NOTE: The DNS parameters must be set correctly to use the SMTP, FTP/HTTP Post and Acu-Cloud functions.

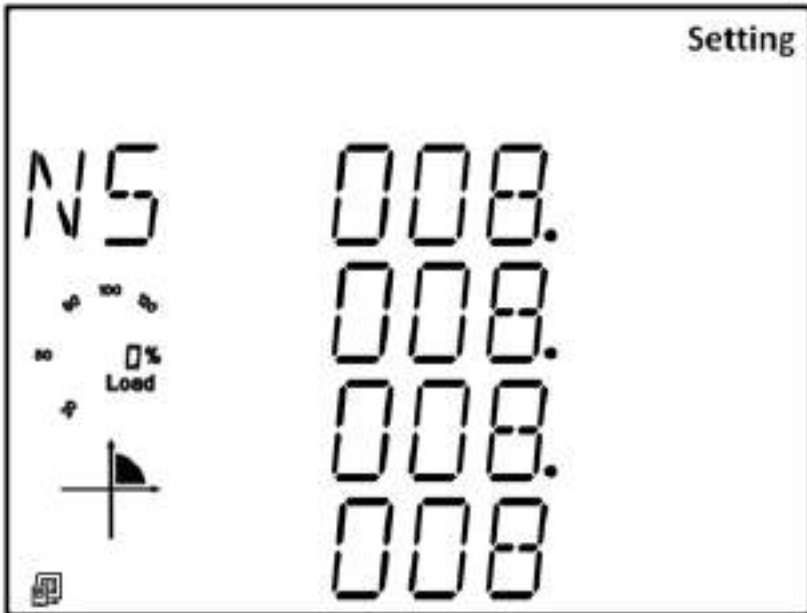

- Press 'E' to get to 'N6' screen, this is the **Secondary DNS Server** setting.
 - Press 'V/A' to enter edit mode and configure the DNS address. The cursor of the first digit will begin to flash.
 - Press the 'H' button to scroll through the digits
 - Press the 'P' or 'E' to change the value of the flashing cursor.
 - Once the secondary dns server address is entered press 'V/A' to confirm.

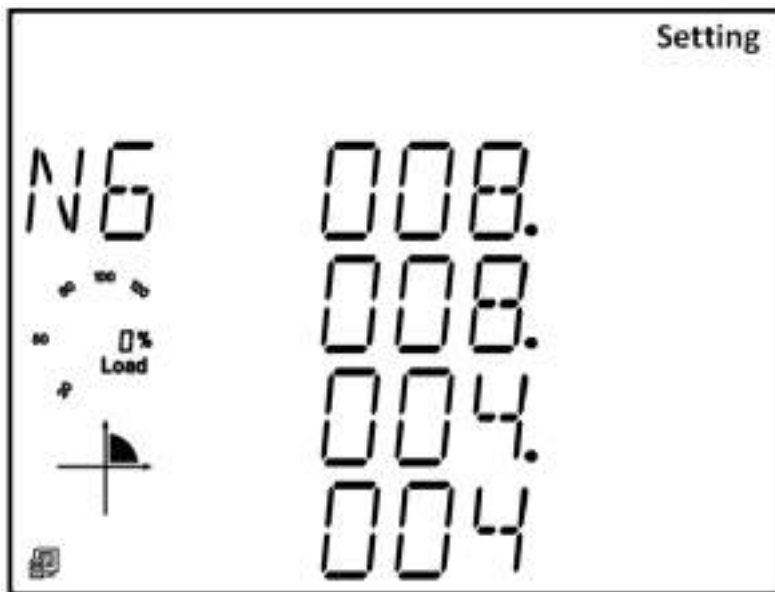

- Press 'P' to get to 'N7', this is the **Modbus Port** setting.
 - Press 'V/A' to enter edit mode and configure the Modbus Port. The cursor of the first digit will begin to flash.
 - Press the 'H' button to scroll through the digits.
 - Press the 'P' or 'E' to change the value of the flashing cursor.
 - Once the Modbus port setting is configured press 'V/A' to confirm.

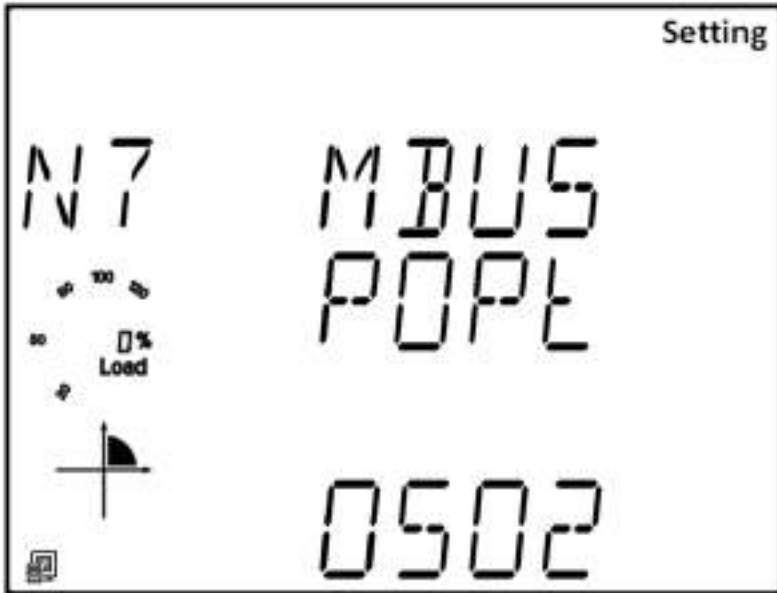

- Press 'P' to get to 'N8', this is the network reset setting. After making any changes to the NET settings (N1-N7), users must reboot the Ethernet module from this page for the settings to take effect.
 - To perform the reboot press 'V/A' to enter edit mode, the cursor will begin to flash.
 - Press the 'P' or 'E' button to change the setting to 'Reset' and press 'V/A' to confirm to reset.
 - The cursor will return to 'No' once successful.

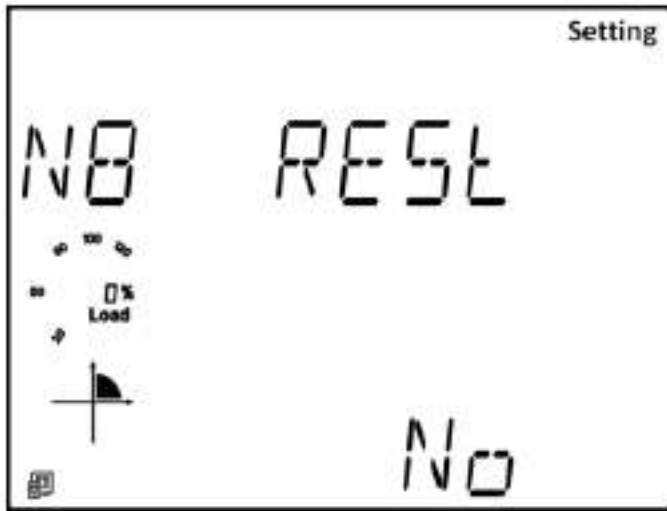

7. Cable

An RJ45 cable is needed to connect the meter to the network.

A shielded twisted pair cable(standard 568A or standard 568B) is recommended as reference to the EIA/TIA standard.

8. Connection method

8.1 Direct Connect to a Computer

The L-WEB can be connected to a computer using a crossover cable(standard 568A). The L-WEB module supports Modbus-TCP and HTTPS Functions for this method of connection.

To connect meter directly to the computer, the following can be done using a computer running the Windows OS:

- Manually connect the meter via Ethernet cable to the computer
- Right click on the connection icon
- Select "Open Network and Internet Settings"



- Once there click on 'Change adapter options'!



- Once there, right click on the Ethernet icon and select properties.



- Select the icon that says Internet Protocol Version 4 TCP/IP



- The Internet Protocol Version 4(TCP/IP) Properties box will pop up. Click on “Use the following IP address” and enter in an IP number so that meter and computer are in the same local network range. For example, if the meter has IP address of 192.168.1.254, then the computer must be assigned with a IP 192.168.1.xxx, where xxx can be any number but cannot be the same as the value the meter has.



- Once you have entered in the IP address, press the Tab key on your keyboard to automatically populate the sub mask setting for the computer.
- Before selecting the OK button make note of the IP address you have assigned to the meter and then press OK.

NOTE: The meters DHCP setting must be set to Manual in order to connect to the meters web interface using a direct meter to computer connection.

8.2 Direct Connect to Router/Switch

The AXM-WEB-PUSH can be connected to a router or switch using a patch cable. The DHCP can be configured to Auto to have the router assign the meter with an IP address or the DHCP can be configured to Manual to set an IP address using the information in Chapter 5.

9. Description of Modbus-TCP Protocol

The Modbus-TCP protocol is used as one of the communication protocols in the L-WEB. The protocol establishes a master and slave connection in Ethernet. The master device (client) first sets up a TCP-IP link with slave device (server). The master device then sends a request to the slave device and the slave device in return sends a response to the master device. The figure below shows how the Modbus-TCP protocol works.



9.1 Protocol

9.1.1 Data Frame Format

MBAP Header	Function	Data
7x8-Bits	8-Bits	Nx8-Bits

9.1.2 Modbus Application Header (MBAP Header) Field

Modbus application header field is the start of the data frame, and consists of seven bytes.

Field	Length	Description
Transaction Identifier	2 Bytes	Identification of a Modbus Request/Response transaction
Protocol Identifier	2 Bytes	Modbus protocol = 0
Length	2 Bytes	Number of following bytes
Unit Identifier	1 Byte	Slave address, in the range of 0~247 decimal.

9.1.3 Function Field

The function code field of a message frame contains eight bits. Valid codes are in the range of 1-255. When a message is sent from a client to a server device, the function code field tells the server what kinds of action to perform.

Code	Meaning	Action
02	Read Digital Input (DI) Status	Obtain current status of Digital Input
03	Read Data	Obtain current binary value in one or more registers
16	Write Multiple-registers	Place specific value into a series of consecutive multiple-registers

9.1.4 Data Field

The data field is constructed using sets of two hexadecimal digits, in the range of 00 to FF. The data field of messages sent from a master to slave contains additional information which the slave must use to take the action defined by the function code. This can include information such as the register addresses, the quantity of registers to query and the count of the actual number of data bytes. For example, if the master requests a slave to read a group of holding registers(function code 03), the data field specifies the starting register and how many registers are to be read.

If the master needs to write data(function code 10 hexadecimal) to a group of registers in the slave, the data field specifies the starting register, how many registers to write, the count of data bytes to follow in the data field and the data to be written into the registers.

9.2 Format of communication

9.2.1 Explanation of frame

Transaction identifier hi	Transaction identifier lo	Protocol identifier hi	Protocol identifier lo	Length hi	Length lo	Unit identifier
00H	00H	00H	00H	00H	06H	01H

Fun	Data start reg hi	Data start reg lo	Data #of regs hi	Data #of regs lo
03H	40H	00H	00H	48H

The meaning of each abbreviated field above is:

Transaction identifier hi: High byte of transaction identifier

Transaction identifier lo: Low byte of transaction identifier

Protocol identifier hi: High byte of protocol identifier

Protocol identifier low: Low byte of protocol identifier

Length hi: High byte of length

Length lo: Low byte of length

Unit identifier: Slave address

Fun: Function code

Data start register hi: High byte of starting register address

Data start register lo: Low byte of starting register address

Data #of registers hi: High byte of number of registers

Data #of registers lo: Low byte of number of registers

Read Status of DI (Function code 02)

1=On

0=Off

There are 28 DIs in the Acuvim L series meter starting at address 0000H.

The following query is to read 4 DI statuses of AXM-IO1 module with logic address of 1 in the Acuvim L series meter.

Query

Transaction identifier hi	Transaction identifier lo	Protocol identifier hi	Protocol identifier lo	Length hi	Length lo	Unit identifier
00H	00H	00H	00H	00H	06H	01H

Fun	Data start reg hi	Data start reg lo	Data #of regs hi	Data #of regs lo
02H	00H	00H	00H	04H

Response

The response includes the MBAP header, function code, quantity of data characters and the data.

An example response from the meter to read the status of 4 Dis(DI1=On, DI2=On, DI3=On, DI4=On) is shown below. The status of each corresponds to the last 4 bits of the data.

DI1: bit0

DI2: bit1

DI3: bit2

DI4: bit3

Transaction identifier hi	Transaction identifier lo	Protocol identifier hi	Protocol identifier lo	Length hi	Length lo	Unit identifier
00H	00H	00H	00H	00H	04H	01H

Fun	Byte count	Data
02H	01H	0FH

The content of the data is,

7	6	5	4	3	2	1	0
0	0	0	0	1	1	1	1

MSB

LSB

Read Data (Function Code 03)

Query

This function allows the user to obtain the measurement results of the Acuvim L series meter.

Below is an example to read 6 registers corresponding to the device clock of the meter, starting at 1040H.

Transaction identifier hi	Transaction identifier lo	Protocol identifier hi	Protocol identifier lo	Length hi	Length lo	Unit identifier
00H	00H	00H	00H	00H	06H	01H

Fun	Data start reg hi	Data start reg lo	Data #of regs hi	Data #of regs lo
03H	10H	40H	00H	06H

An example response is provided to read the time (2006-12-18 14:15:20).

Transaction identifier hi	Transaction identifier lo	Protocol identifier hi	Protocol identifier lo	Length hi	Length lo	Unit identifier
00H	00H	00H	00H	00H	0FH	01H

Fun	Byte count	Data1 hi	Data1 lo	Data2 hi	Data2 lo	Data3 hi	Data3 lo	Data4 hi	Data4 lo	Data5 hi	Data5 lo	Data6 hi	Data6 lo
03H	0CH	07H	D6H	00H	0CH	00H	12H	00H	0EH	00H	0FH	00H	14H

Preset/Reset Multi-Register(Function Code 16)

Query

This function code allows the user to modify the contents of a register. The example below is a request to an Acuvim L series meter with device address 1 to preset the CT1(500) and CT2(5) registers. The CT1 data address is 1008H and CT2 is at 1009H.

Transaction identifier hi	Transaction identifier lo	Protocol identifier hi	Protocol identifier lo	Length hi	Length lo	Unit identifier
00H	00H	00H	00H	00H	0BH	01H

Fun	Data start reg hi	Data start reg lo	Data #of regs hi	Data #of regs lo	Byte count	Value 1 hi	Value 1 lo	Value 2 hi	Value 2 lo
10H	10H	08H	00H	02H	04H	01H	F4H	00H	05H

Response

The normal response to the command request is to retransmit the message as received after the relay output status has been altered.

Transaction identifier hi	Transaction identifier lo	Protocol identifier hi	Protocol identifier lo	Length hi	Length lo	Unit identifier
00H	00H	00H	00H	00H	06H	01H

Fun	Data start reg hi	Data start reg lo	Value hi	Value lo
10H	10H	08H	00H	02H

10. Web Interface Readings and Parameter Settings

The L-WEB module supports the HTTPS protocol to allow users to access the meters web interface. The user will need to access the L-WEB web interface to configure the module and to further use its functions. The web interface allows for remote initial setup of the Acuvim L meter.

The L-WEB web interface allows for different user access levels.

10.1 User Access Login

Enter the correct IP address of the module in the search bar of the internet browser to access the web interface of the L-WEB.

NOTE: *The recommend internet browser for the L-WEB is either Google Chrome or Firefox.*

The user will be redirected to a login web page where users will have to enter in the Access Level and enter appropriate password for that level.

The **User** access level is ideal for users who need only to take readings and view status from the meter.

The default password for the User level is **view**.

It is recommended that no more than 5 users are logged in at the same time for this level to ensure optimal performance of web interface.

The **Admin** access level is ideal for users who need access to configurations on the meter, the web interface and to view readings.

The default password for the Admin level is **admin**.

The L-WEB web interface will only allow one admin to be logged in at a time. If another user logs in at this access level, the previous user will be logged out.



The two different access levels are summarised below:

Access Level	Default Password	Read Parameter/Status	Configure Settings
User	view	Yes	No
Admin	admin	Yes	Yes

10.2 Dashboard

In the dashboard, the user will find the tabs to access different pages in the web interface such as 'Metering', 'About', and 'Settings'. The dashboard is the first page the user will see once they have entered the correct password for the appropriate access level. The dashboard is the same for both access levels.

The dashboard displays selected parameters from the different groups of metering parameters such as "Basic Metering", "Power & Energy", 'THD' and "Max Demand". Clicking on "Full report" under any one of these four metering parameter groups will take the user to the web page which contains all the parameters supported by that metering parameter group.

The dashboard also displays how long the L-WEB module has been connected to the network since the last reboot of the module in the bottom left corner of the page.

The parameters on this page are updated every 5 sec.



10.3 Metering web page

Click on the 'Metering' tab to visit the metering data web pages. There are 8 kinds of metering parameter web pages. They are 'Basic Metering', 'Power & Energy', 'Min/Max', 'THD', 'Harmonics', 'Phase Angles', 'Sequence', and 'I/O'. Each web page shows data from the Acuvim L series meter.

Basic Metering:

The Basic Metering web page includes the data of real-time parameters for the Acuvim L series meter. This includes the Line Voltages, Phase Voltages, Current, Neutral Current, Active, Reactive and Apparent Power, Power Factor, Frequency, Load type and Wiring status.

The parameters on this page are updated every 5 seconds.

The values displayed in this web page will depend on the wiring configuration mode of the meter. For example, if the meter is configured as '3LL' then the metering web page will display '0.00' for the Phase Voltages/Powers.

Parameter	Phase A	Phase B	Phase C	Average	Total
Instant kW	38.261				
Active Energy kWh	191.000	191.000	191.000	191.000	-
Reactive Energy kWh	0.000	0.000	0.000	0.000	-
Current A	119.565	119.565	119.565	119.565	358.700
Active Power W	0.207	0.207	0.207	-	0.621
Reactive Power var	-11.597	-11.597	-11.597	-	-34.791
Apparent Power VA	14.430	14.430	14.430	-	43.290
Power Factor	0.999	0.999	0.999	-	0.999
Voltage Imbalance	0.200				
Current Imbalance	0.000				
Load Type	C				
Using Meter	ON				

Power & Energy:

The Power & Energy web page shows the energy data for the Acuvim L series meter such as the Active and Reactive energy that is consumed and delivered as well as the Apparent energy per phase.

This web page also shows the Demand parameters for the Active, Reactive and Apparent Power as well as the three phase Current demands.

The parameters in this web page are updated every 5 seconds.

Min/Max:

The Min/Max page shows the maximum and minimum statistics that the meter has recorded since the lifetime of the meter or from the last time the min/max statistics were reset. This page also shows the timestamps they were recorded at.

The parameters in this web page are updated every 10 seconds.

THD:

The THD web page shows the power quality data such as the THD, THFF, Crest Factor and K Factor for both the voltage and current.

The parameters in this web page are updated every 15 seconds.

Parameter	Phase A	Phase B	Phase C	MaxTHD	Average
VHD Voltage %	2.300	2.200	2.500	-	2.300
IHD Current %	10.900	11.200	10.500	9.000	10.400
VHD Dist Line Voltage %	2.300	2.200	2.500	-	-
IHD Dist Line Current %	9.800	9.800	9.800	-	-
Line Factor Line Voltage	1.415	1.415	1.415	-	-
Line Factor Line Current	0.700	0.700	0.700	-	-
VHD Dist Current %	10.900	11.200	10.500	9.000	-
IHD Dist Current %	9.800	9.800	9.800	9.000	-
K Factor Current	88.000	88.700	88.000	9.000	-

Harmonics:

The Harmonics web page will show the harmonics of the voltage and the current waveform being measured. It will display the harmonics of each phase in a graphical and tabular format. Select between voltage and current to view their respective harmonics as well as between the 2nd-31st harmonics or 32nd-63rd from the drop down list.

The parameters in this web page are updated every 15 seconds.



Phase Angles:

The Phase Angles web page will show the phase angles of the voltage and current waveform being measured which can be used for remote troubleshooting. This page provide a visual diagram of the phase angles with respect to the voltage connected to the Phase A voltage input.

The parameters in this web page are updated every 5 seconds.

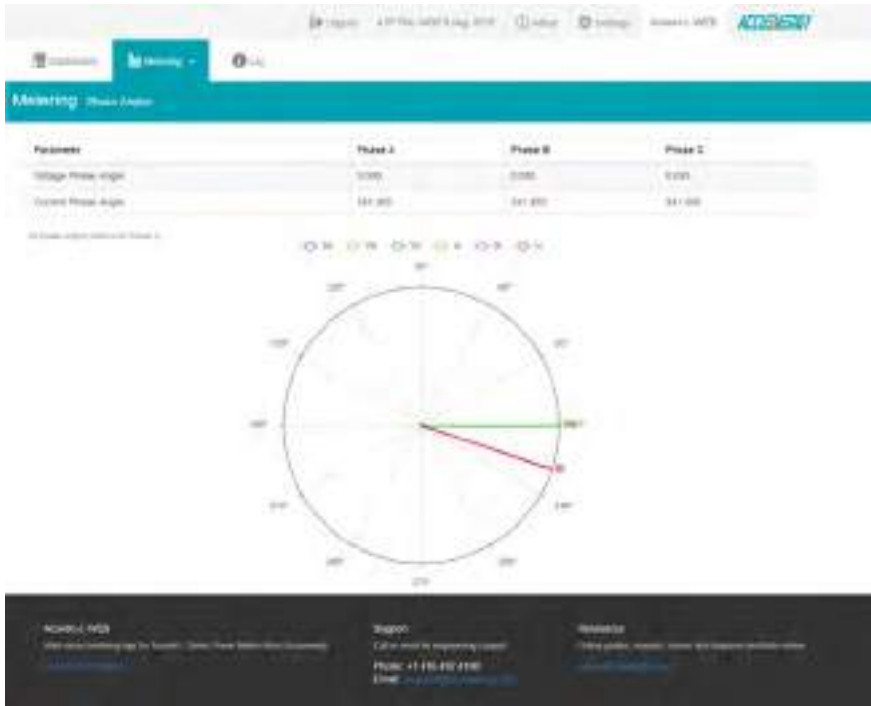

Sequence:

The Sequence web page will show the positive, negative and zero components of the voltage and current waveform being measured.

The parameters in this web page are updated every 15 seconds.

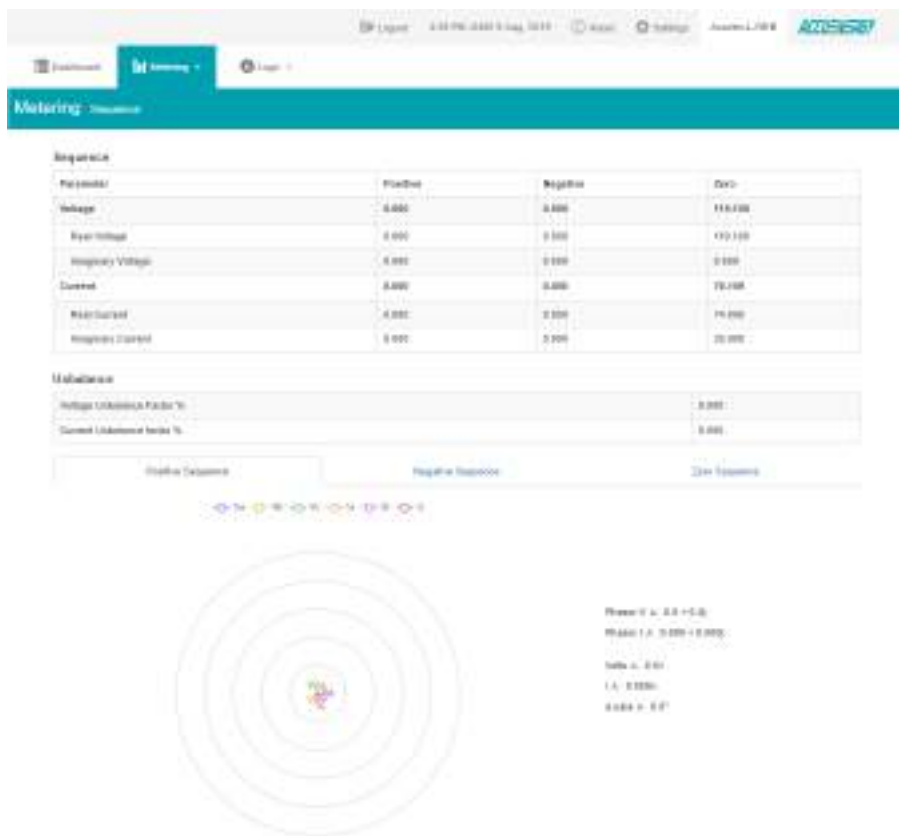

I/O:

The I/O web page will display the status of the I/O modules that are connected and their DI and DO values.

The parameters in this web page are updated every 5 seconds.

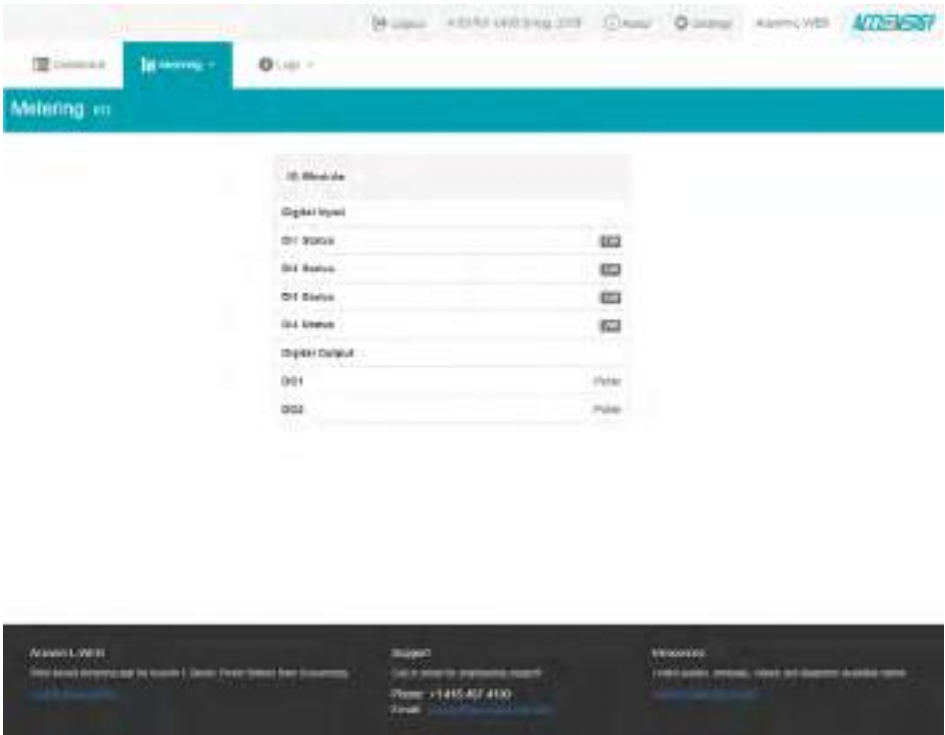

10.4 Status web page



Click on the 'Logs' tab to visit the metering logs web pages.

There are five kinds of logs that can be viewed, they are "Trend Log", "Data Log", "Alarm Log", "SOE Log" and "PQ Event Log". Each web page shows data from the Acuvim L series meter.



Trend Log:

The Trend Log web page includes the real-time and energy trend diagram. The real-time trend log diagram can be selected to show the following parameters phase voltage, line voltage, current, active power, reactive power, apparent power and power factor for each phase as well as the totals. The energy trend log shows the imported and exported active energy, reactive energy, total energy, net energy and apparent energy.

The data of the trend log can be previewed and downloaded as a .csv file by clicking the '**Data Review**'  and '**Data**'  icons on the right top side of the diagram. The trend log diagram can also be saved as an image by clicking the '**Image**'  icon.

Realtime:

The real time parameters can be trended at different time intervals depending on the Time Frame selected. Listed below are the time intervals for each possible time frame setting:

Time Frame	Time Intervals
Last 10 minutes	5 second 15 seconds 1 minute
Last 1 Hour	1 minute
Today	15 minutes 1 hour
Yesterday	15 minutes 1 hour
Last 7 days	15 minutes 1 hour 1 day
Last 30 days	1 hour 1 day
Last Month	1 hour 1 day
Custom Range	Dependent on range specified



Energy:

Similarly the energy parameters can be trended at different time intervals depending on the Time Frame selected. The table below displays the time intervals:

Time Frame	Time Intervals
Last 1 Hour	1 minute
Today	15 minutes 1 hour
Yesterday	15 minutes 1 hour
Last 7 days	15 minutes 1 hour 1 day
Last 30 days	1 hour 1 day
This Month	1 hour 1 day
Last Month	1 hour 1 day
Last year	1 day 1 month
Custom Range	Dependent on range specified



Data Preview:

The data preview allows the user to view the graphical data in tabular form.

User can also download this data into a csv file for further examination.

Time	Phase A	Phase B	Phase C	System
00:00:00	0.0	0.0	0.0	0.0
00:00:05	0.0	0.0	0.0	0.0
00:00:10	0.0	0.0	0.0	0.0
00:00:15	0.0	0.0	0.0	0.0
00:00:20	0.0	0.0	0.0	0.0
00:00:25	0.0	0.0	0.0	0.0
00:00:30	0.0	0.0	0.0	0.0
00:00:35	0.0	0.0	0.0	0.0
00:00:40	0.0	0.0	0.0	0.0
00:00:45	0.0	0.0	0.0	0.0
00:00:50	0.0	0.0	0.0	0.0
00:00:55	0.0	0.0	0.0	0.0
00:01:00	0.0	0.0	0.0	0.0

Data Log:

The data log web page includes all the data files for data log and Acuccloud.

You can select the between Data Log and AcuCloud by clicking on the tab located on the left side of the web page. Once the Data log is selected, the log file for will show on the screen with the update time and file size. To download the file, click on the download icon  to save the file in the computer. The data log will be saved as a compressed csv file.

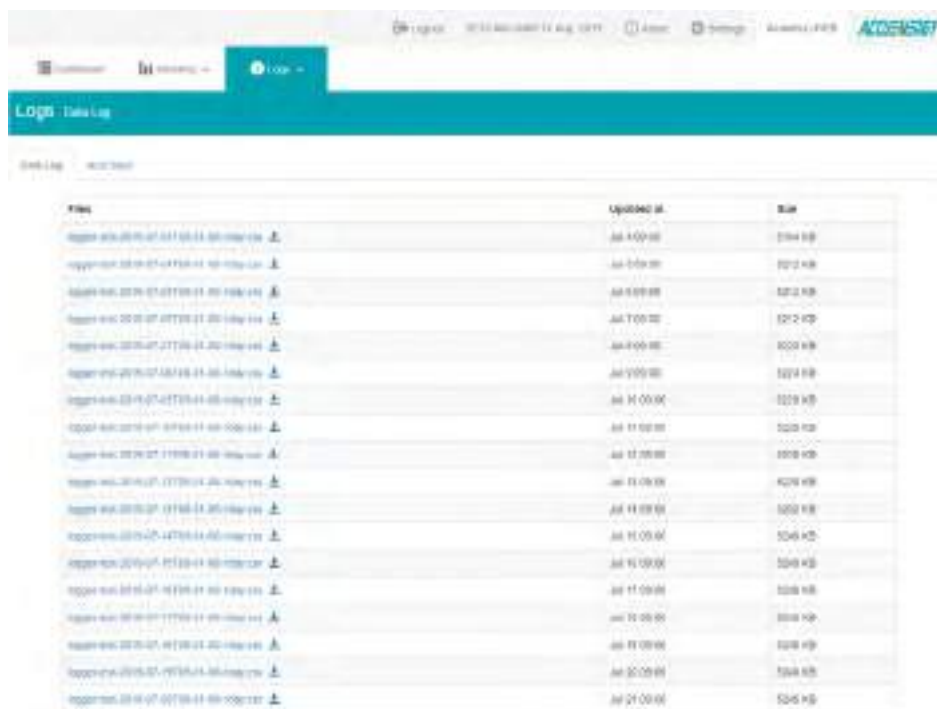

File	Updated At	Size
logfile-2018-08-07-14:52:14-00-1000-000	2018-08-07 14:52:14	5194 KB
logfile-2018-08-07-14:52:14-00-1000-000	2018-08-07 14:52:14	5202 KB
logfile-2018-08-07-14:52:14-00-1000-000	2018-08-07 14:52:14	5212 KB
logfile-2018-08-07-14:52:14-00-1000-000	2018-08-07 14:52:14	5212 KB
logfile-2018-08-07-14:52:14-00-1000-000	2018-08-07 14:52:14	5200 KB
logfile-2018-08-07-14:52:14-00-1000-000	2018-08-07 14:52:14	5224 KB
logfile-2018-08-07-14:52:14-00-1000-000	2018-08-07 14:52:14	5219 KB
logfile-2018-08-07-14:52:14-00-1000-000	2018-08-07 14:52:14	5223 KB
logfile-2018-08-07-14:52:14-00-1000-000	2018-08-07 14:52:14	5208 KB
logfile-2018-08-07-14:52:14-00-1000-000	2018-08-07 14:52:14	5208 KB
logfile-2018-08-07-14:52:14-00-1000-000	2018-08-07 14:52:14	5202 KB
logfile-2018-08-07-14:52:14-00-1000-000	2018-08-07 14:52:14	5246 KB
logfile-2018-08-07-14:52:14-00-1000-000	2018-08-07 14:52:14	5246 KB
logfile-2018-08-07-14:52:14-00-1000-000	2018-08-07 14:52:14	5208 KB
logfile-2018-08-07-14:52:14-00-1000-000	2018-08-07 14:52:14	5208 KB
logfile-2018-08-07-14:52:14-00-1000-000	2018-08-07 14:52:14	5246 KB
logfile-2018-08-07-14:52:14-00-1000-000	2018-08-07 14:52:14	5246 KB

Alarm Log:

The Alarm Log web page provides the user with a summary of the alarm events that have occurred with the meter. It will show the status of up to 16 alarm events indicating the status, parameter, value and timestamp of the alarm event.

Once all 16 alarm events are full, the newest alarm event will then wrap around to alarm 1. The parameters in the alarm status web page are updated every 10 seconds.



Timestamp	Status	Parameter	Value
2020-08-12 10:31:50.000	Alarm	Phase A Current Ia	110.000
2020-08-12 10:37:11.700	Warn	Phase A L-NO-NO-Phase Voltage Va	110.000

SOE Log:

The SOE web page will display the Sequence of Event log for the enabled I/O module that is attached to the Acuvim L series meter with timestamps and will display the DI status for up to 20 SOE events. The SOE must be enabled from the Acuvim software.

The SOE log parameters are updated every 10 sec.

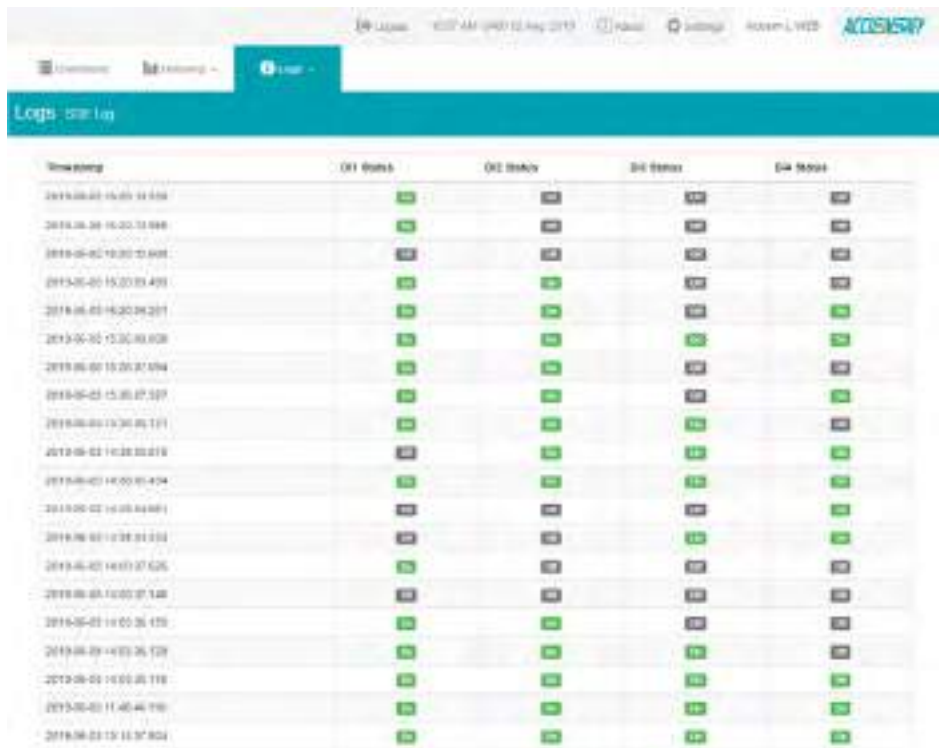

Timestamp	O1 Status	O2 Status	O3 Status	O4 Status
2019-08-01 15:01:11.634	OK	OK	OK	OK
2019-08-01 15:20:13.998	OK	OK	OK	OK
2019-08-01 15:20:13.998	OK	OK	OK	OK
2019-08-01 15:20:13.433	OK	OK	OK	OK
2019-08-01 14:20:04.201	OK	OK	OK	OK
2019-08-01 15:20:03.628	OK	OK	OK	OK
2019-08-01 15:20:03.594	OK	OK	OK	OK
2019-08-01 15:20:03.537	OK	OK	OK	OK
2019-08-01 13:30:05.131	OK	OK	OK	OK
2019-08-01 11:28:03.019	OK	OK	OK	OK
2019-08-01 14:00:01.424	OK	OK	OK	OK
2019-08-01 14:00:01.409	OK	OK	OK	OK
2019-08-01 11:28:01.033	OK	OK	OK	OK
2019-08-01 14:01:07.626	OK	OK	OK	OK
2019-08-01 11:00:07.148	OK	OK	OK	OK
2019-08-01 11:00:06.470	OK	OK	OK	OK
2019-08-01 11:00:06.129	OK	OK	OK	OK
2019-08-01 11:00:05.718	OK	OK	OK	OK
2019-08-01 11:40:44.710	OK	OK	OK	OK
2019-08-01 11:37:50.4	OK	OK	OK	OK

PQ Event Log:

Note: Only Acuvim-DL meter and Acuvim-EL meter support PQ Event Logs.

PQ event log will display the power quality issues detected by Acuvim L meter. The event log will include the timestamp and the reason of triggering the PQ Event log.

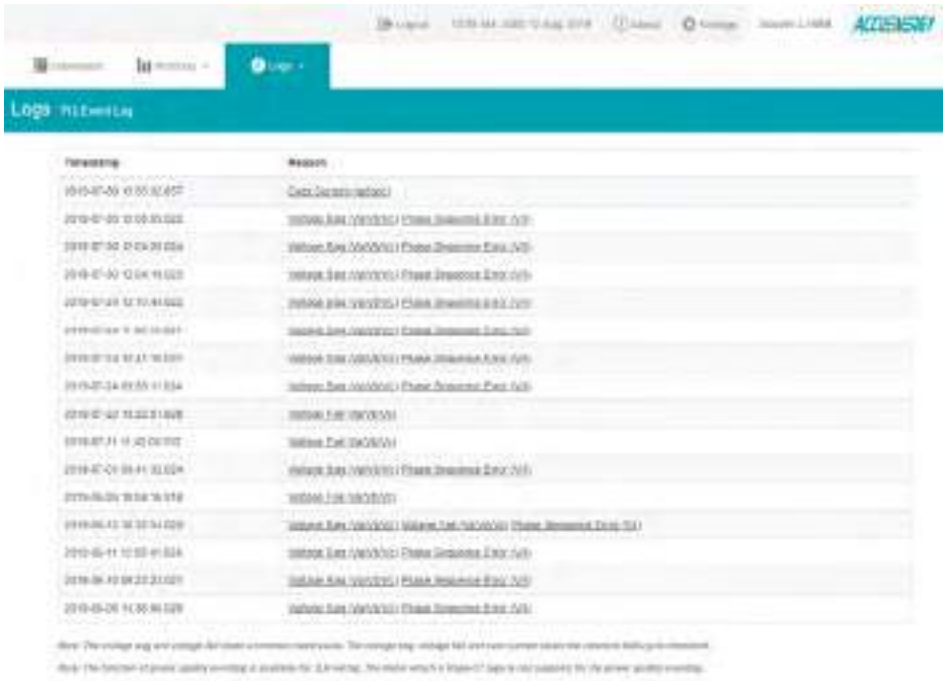

10.5 About

The About tab located at the top right corner of the web interface allows users to view the Device Information page. This page provides users with information about the Acuvim L series meter and the L-WEB module. The Device Information contains the model of the Acuvim L meter, serial number, firmware version and the meter addresses. It also contains the serial number, firmware version, hardware version and the MAC addresses of the L-WEB module.

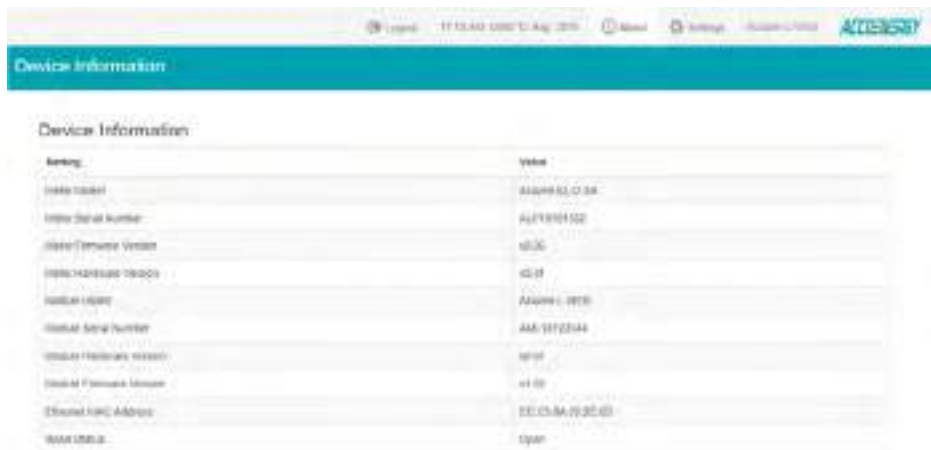

The screenshot shows a web interface titled 'Device Information'. It contains a table with two columns: 'Setting' and 'Value'. The table lists various device parameters and their current values.

Setting	Value
Device ID	ASAPR01034
Order Serial Number	AJ1918102
Manufacturer Vendor	AGC
Manufacturer Model	4201
Manufacturer Name	AMMCO, INC
Manufacturer Number	AM-1112344
Manufacturer Website	AMC
Manufacturer Address	4100
External MAC Address	EE:05:5A:03:00:00
Serial Number	12345

10.6 Settings web page

Meter

The basic metering configurations needed to set up the meter can be applied from the web interface by clicking on Settings and selecting the 'Meter' tab.

Device Description: A description for the meter can be provided in this field which will display on the Dashboard page.

Voltage Wiring: Select the type of wiring that the meter will be monitoring from the modes in the drop down list.

Current Wiring: Select the number of CT's that will be connected to the meter to measure the current.

PT1: Enter the rated input of the potential transformer that is connected to the meter. Possible range is from 50 to 1,000,000V. By default PT1 is 400.

PT2: Enter the rated output of the potential transformer. Possible range is from 50 to 400V. The default PT2 setting is 400.

NOTE: If the voltage input is connected directly to the meter and there are no PTs (Potential Transformers) stepping down the voltage to the meters voltage input then the PT1 and PT2 settings can be left as the default of 400.

CT1: Enter the rated input of the current transformer that is used with the meter. Possible ranges for the CT1 are from 1 to 50000A.

The default settings for CT1 are dependent on the current input type of the Acuvim II meter. The following table displays the default CT1 values for the different Current input options.

Acuvim L Current Input	Default CT1 Value
1A	1
5A	5
333mV	1
RCT	1000
80mA/100mA/200mA	1

CT2: Select the rated output of the current transformer from the drop down list. By default this setting is already configured.

NOTE: CT2 is configurable only for 5A and mA current inputs, 5A can be either 5A or 1A and mA can be either 80mA, 100mA or 200mA.

Neutral Current Reading: Select the mode of the neutral current readings for the meter. By default the meter is in calculated mode which will require phase current to calculate the neutral current. Configuring the meter in Measure mode does not require any calculation. The neutral current will be measured directly by meter.

I A Direction: Represents the flow of direction for the Phase A current being measured, configure this setting to troubleshoot issues related to incorrect polarity of readings such as real power, Power Factor and etc.

I B Direction: Represents the flow of direction for the Phase B current being measured, configure this setting to troubleshoot issues related to incorrect polarity of readings such as real power, Power Factor and etc.

I C Direction: Represents the flow of direction for the Phase C current being measured, configure this setting to troubleshoot issues related to incorrect polarity of readings such as real power, Power Factor and etc.

Wiring Detection: Enable wiring detection to check if the wiring of the CTs and voltage input is correct.

Demand Calculation: Demand calculating mode can be set as sliding window, fixed window, rolling window and thermal according to user. When using the sliding window interval method, user selects an interval from 1 to 30 minutes, which is the period of the calculation. The demand updates every 1 minute as the window slides once. Thermal demand method calculates the demand based on a thermal response which mimics a thermal demand meter. User selects the period for the calculation and the demand updates at the end of each period.

- **Sliding Window Demand**

You select an interval from 1 to 30 minutes, which is the period of the calculation. The demand updates every 1 minute as the window sliding once.

- **Fixed Window Demand**

You select a period time from 1 to 30 minutes, which is the period of the calculation. The demand updates once as the period time.

- **Rolling Window Demand**

You select a period time from 1 to 30 minutes, which is the period of the calculation. And you select an interval time, which is the rolling time. The period time is must the rolling time integer times. The demand updates once as the rolling time over.

- **Thermal Demand**

Thermal demand method calculates the demand based on a thermal response which mimics the thermal demand meter. You select the period for the calculation and the demands update at the end of each period.

Energy Reading: User can choose primary energy or secondary energy by pressing key or via communication. The energy will be reset when user switch the mode of energy calculation (primary energy or second energy). And accumulate the energy again.

Reactive Energy Calculation Method: There are two ways to calculate reactive energy(power): Mode 0: real reactive energy; Mode 1: general reactive energy

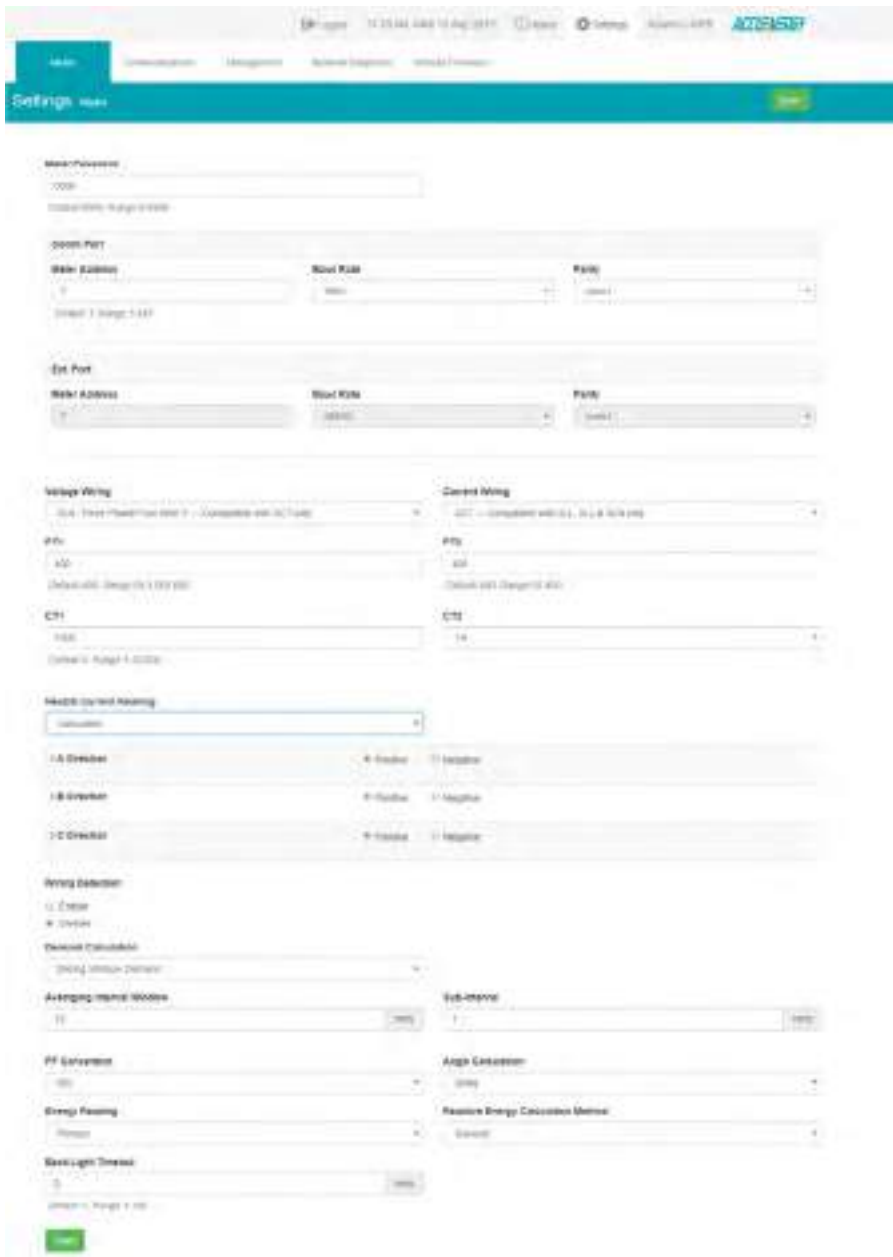

Communication

The basic metering configurations needed to set up the meter can be applied from the web interface by clicking on Settings and selecting the 'Meter' tab.

The communication setting web page will allow the user to configure settings related to the Ethernet network. The functions that the L-WEB support can be configured from this web page by selecting the corresponding tab such as Emails, Time/Date , Datalog, HTTP/FTP Post, Acu-Cloud Post for communicating with the AcuCloud software, SNMP, BACnet and DNP3.

Network:

DHCP: Select 'Manual' to manually configure the IP address to access the meter. If set to 'Manual', you'll also need to set the Subnet Mask and Gateway.

Select 'Auto' to have the meter assigned a IP address automatically. With this selection the Subnet Mask, Gateway and DNS servers will also be automatically assigned.

NOTE: After changing DHCP to Auto, check the display of the meter to obtain the new IP address that has been assigned after the L-WEB has completed its reboot and the router has assigned the meter with an IP address.

IP Address: If the DHCP is configured to Manual, the IP address can be configured from this page.

Subnet Mask: If the DHCP is configured to Manual, the Subnet Mask can be configured from this page.

Gateway: If the DHCP is configured to Manual, the Gateway can be configured from this web page.

DHCP DNS Server 1: Enter the address of the DNS 1 server in this page.

DHCP DNS Server 2: Enter the address of the DNS 2 server in this page.

Allow HTTP: Enable this setting so that the L-WEB can be accessed through HTTP at port 80.

HTTPS Port: Enter the HTTPS port number of the meter. By default, this setting is configured to 443. The range can be from 6000 to 9999.

NOTE: This setting should never be configured to 80.

Modbus TCP Port: Enter the Modbus port number of the meter. By default, this setting is configured to 502. The range can be from 2000 to 5999.

Proxy Server Enabled: Enable this setting so that the L-WEB can act as an intermediary to communicate with another server.

Click 'Save' after changing any settings. Users will be prompted to reboot the L-WEB immediately or later. If later is chosen the L-WEB will need to be rebooted from the 'Management' page.

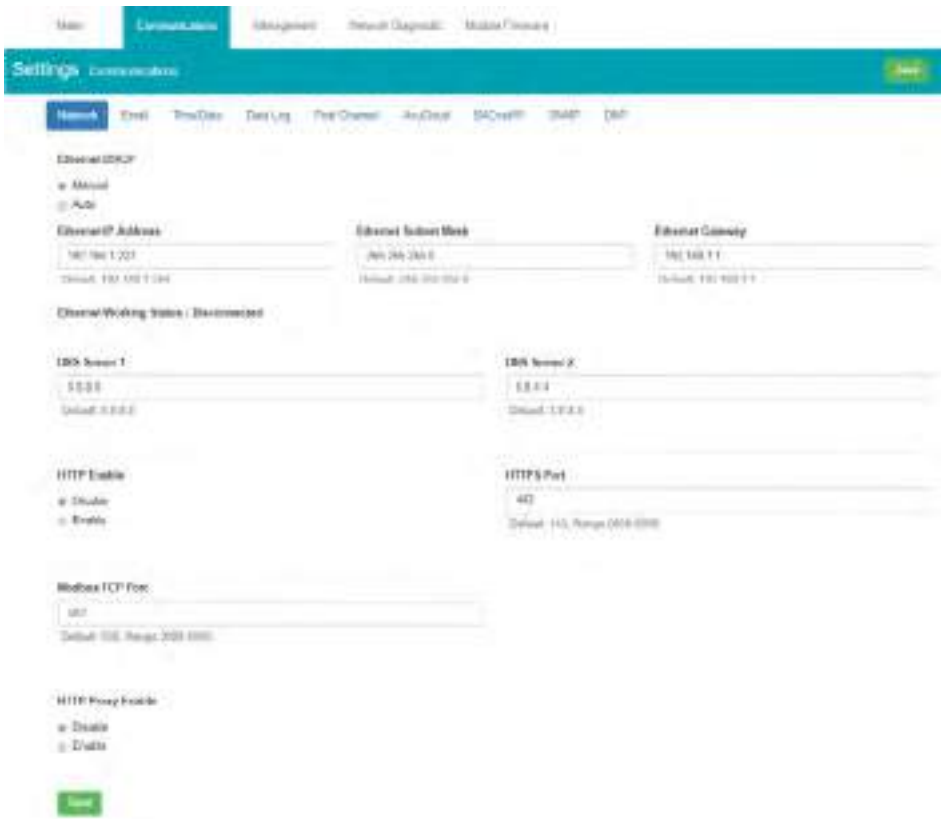

Email

The L-WEB supports the SMTP protocol where users can setup the email function to enable the meter to send emails based on a specific time interval or whenever there is an alarm or SOE event or a combination of both. The Email configuration page can be accessed by clicking on the '**Email**' tab on the settings page. Users must know their SMTP server provider and details regarding their SMTP server, which can be provided by users' IT personnel.

There are three modes available for sending emails that the user can enable.

The first mode is '**Triggered Sending**' where emails are sent immediately when there is a new alarm, SOE, or waveform event.

The second mode is '**Timed Sending**' where users can receive emails at a certain period of time based on the time interval configured. The email will include the data that is selected to be sent.

The third mode is when both of the above are enabled.

To use this function the following settings need to be configured:

SMTP Enabled: Select 'Enable' to enable and to further configure the settings related to the SMTP function.

Start Time to Send Email: Select the date and time for when the emails should begin to send.

Click on the  icon to configure the time and date.

Click on the  icon in the bottom right to clear the time and date.

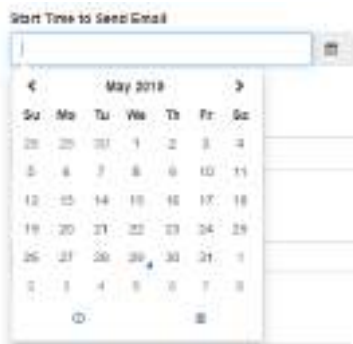

SMTP Server: Enter the URL of a valid SMTP server. I.E. mail.accuenergy.com or smtp.gmail.com

SMTP Port: Enter the port number associated with the SMTP server.

SMTP From: Enter a name or phrase which will appear to let you know who the mail is from. I.E. 'Technical Support'

SMTP Username: Enter the SMTP user name for the SMTP server set above.

SMTP Password: Enter the SMTP user password for the user set above.

SMTP To Address 1;2;3: Enter up to three recipients that you wish to have the email sent to in 'SMTP To Address 1', 'SMTP To Address 2' and 'SMTP To Address 3'.

Test Address 1,2,3: Test the if the email can be sent to 'SMTP To Address 1', 'SMTP To Address 2', 'SMTP To Address 3'.

NOTE: The test function will only show the true result once the settings are saved and a reboot is performed on the module.

After configuring the above settings, the next step is to select the content for the emails.

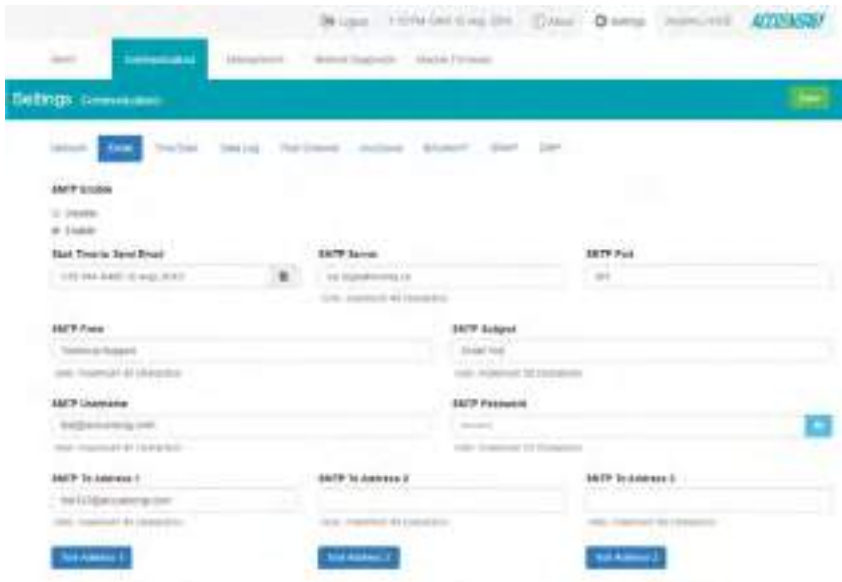

The content of the emails can either be time based triggered or event based triggered.

For receiving emails on a time based under Enable Periodic Email Reporting:

Enter a time between 5-1440 minutes in the 'Set time interval'

- Check off the box beside the parameters for the content the user should receive.
 - **Metering Data:** Report on Real-time voltage, current, power and etc.
 - **Energy Data:** Report on energy parameters.
 - **Harmonics Data:** Report on the voltage and current harmonics from 2nd to 63rd.
 - **Sequence & Phase Angles:** Report on the positive, negative and zero components of the voltage and current waveform.
 - **Min/Max:** Report on the maximum and minimum statistics that the meter has recorded since the lifetime of the meter or from the last reset of the min/max statistics.
 - **Alarm:** Report of the alarm log.
 - **SOE Record:** Report of the SOE log.
 - **PQ Event Data:** Report of PQ Event.

The user will receive an email with csv file attachment.

For receiving emails on a event based select either Alarm Event, SOE Record or PQ Event Data under the Enable Real-time Email Reporting.

The user will receive an email with csv file attachment corresponding to the triggered event selected.

Click 'Save' after changing any settings. Users will be prompted to reboot the L-WEB immediately or later. If later is chosen the L-WEB must be rebooted from the 'Management' page in order for the configurations to take effect.



Time/Date

The device clock of the Acuvim L series meter can be set through the web interface of the L-WEB module. The L-WEB module also supports the SNTP (Simple Network Time Protocol) protocol so that the module can update the meter's device clock by synchronizing with a time server.



The module can sync with up to 3 time servers. If a time server is down, the module will synchronize with the second or third time server if they are configured.

The settings for the time and date can be found by clicking on the 'Settings' and selecting the 'Communications' tab. Users can select 'Time/Date' to configure the time settings.

The following must be configured to set the time/date and NTP settings:

SNTP Enabled: Select enable to further configure the settings related to the NTP (Network Time Protocol) function

Device Clock: Configure the date and time on the meter

- Click on the  icon to configure the date and time.
- Click on the  icon in the bottom right to clear the time and date.

Sync Time: Click on Force Update to have the L-WEB sync its time with the SNTP server

SNTP Server 1;2;3: Enter up to 3 SNTP servers in the "SNTP Server 1", "SNTP Server 2" and "SNTP Server 3" fields.

Examples of North American SNTP servers are:

0.us.pool.ntp.org

1.us.pool.ntp.org

2.us.pool.ntp.org

3.us.pool.ntp.org

For more NTP servers based on region, visit the following site:

<http://www.pool.ntp.org/en/>

Time Zone: Select the time zone the meter is in or the time zone in which you would like the meter's time to be synchronized to from the drop down list. Users can also select the timezone by clicking on the region in the map.

Click 'Save' after configuring the time settings. Users will be prompted to reboot the L-WEB immediately or later. If later is chosen the L-WEB must be rebooted from the 'Management' page in order for the settings to take effect.

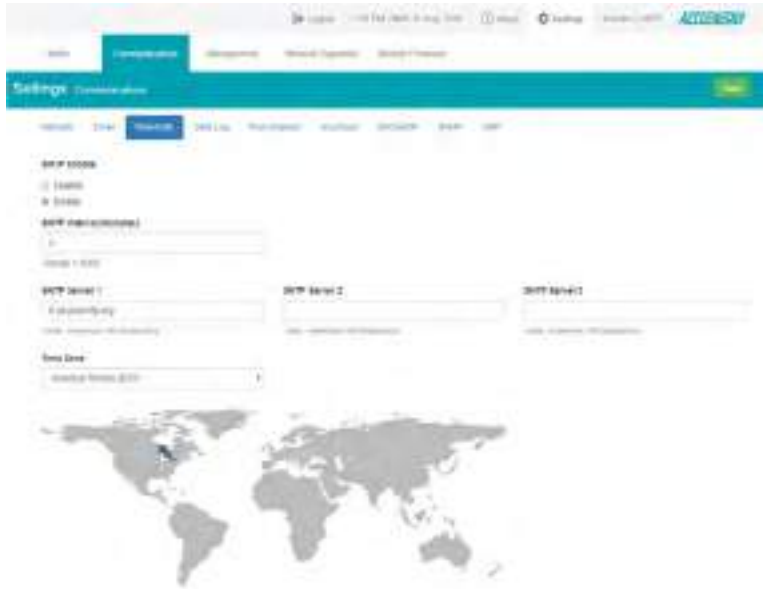

Data Log

The L-WEB supports logging data onto its on board memory.

The data can be downloaded as a .csv file from the datalog page in the logs section or by using a HTTP/FTP client.

Logger Enable: To use the data log function to log the data onto the module, select 'Enable' to view and configure the settings that are applicable.

Timestamp Format: Select the format of the timestamp for the data that is logged. The format for the timestamp can be based on the Local Time, UTC Seconds or based on ISO8601 Format.

Log File Name Format: Select the format of the log file name for the data that is logged. The format for the log file name can be based on the UTC timestamp or based on Time Interval Format.

Log Interval: Select how frequently the meter will log data to the file that will be uploaded to the server from the drop down list. The logging interval can be from 15 second to 1 month.

Log File Name Prefix: Provide a name for the log file posted to post channel which will be appended to the beginning of the log file if "Time Interval Format" is selected as the Post File Name Format. By default "logger1" will be appended to the beginning of the log file.

Log File Length: Select the length of the local log file as from 1 minute to 1 month of data from the drop down list.

Backup File Length: Select the length of the backup log file as 1 day, 7 days or 1 month of data from the drop down list.

The screenshot shows the 'Settings' page for 'Data Log' configuration. The page has a teal header with 'Settings' and 'Communications' on the left, and a 'Save' button on the right. Below the header is a navigation bar with tabs for 'Network', 'Email', 'Time/Date', 'Data Log' (selected), 'Post Channel', 'Alarm/Event', 'BACNET/IP', 'SNMP', and 'DNP'. The main content area is titled 'Data Log' and contains several sections:

- Logger Enable:** Radio buttons for 'Disable' and 'Enable' (selected).
- Timestamp Format:** Radio buttons for 'Local Time String (e.g., 2017-04-01 12:00)', 'UTC Second (Number of seconds that have elapsed since 1970-01-01 00:00:00 Coordinated Universal Time)', and 'ISO8601 Format (e.g., 2017-04-01T13:00:00Z)'. The 'Local Time String' option is selected.
- Log File Name Format:** Radio buttons for 'UTC Timestamp (e.g., logger1-1804070000.csv)' and 'Time-ISO8601-Prefix (e.g., logger1-2017-04-01T13:00:00.csv)'. The 'Time-ISO8601-Prefix' option is selected.
- Log Start Time:** A text input field containing '3:01 AM - 04:00 S, Jul, 2013' and a calendar icon.
- Log Interval:** A dropdown menu set to '15 seconds'.
- Log File Name Prefix:** A text input field containing 'logger500'. Below it, an example is shown: 'e.g., logger1-2017-05-01T05:46-http.csv'.
- Log File Length:** A dropdown menu set to '5 minutes'.
- Backup File Length:** A dropdown menu set to '1 day'.
- SMTP Enable:** Radio buttons for 'Disable' and 'Enable' (selected).

At the bottom of the page, there is a 'Save' button.

SFTP Enable: To download the logged data from the module using a FTP client, select Enable. The log file will then be available to be downloaded using a FTP client using the following credentials:

Host: sftp://IPaddressofthemeteter

Username: sftpuser

SFTP Password: accuenergy

Port: 22

By default the password for retrieving the backup log files is accuenergy. The user can configure any password or can reset to the default of accuenergy by clicking on the "Reset SFTP Password".

NOTE: After enabling the SFTP function the user must reboot the communication module in order to access the data logs with the default password of 'accuenergy'.

Click 'Save' after changing any settings. Users will be prompted to reboot the L-WEB immediately or later. If later is chosen the L-WEB must be rebooted from the 'Management' page in order for the changes to take effect.

Post Channel

The L-WEB supports the HTTP and FTP Post functions to send data from the meter to a HTTP/FTP server. The L-WEB can post .csv files to three different HTTP or FTP servers using HTTP Post or FTP Post.

In the case when there is no connection to the server, the L-WEB will store the posts and send it out after the connection is restored. A maximum of 3000 files will be buffered on module. The Clear Post Channel Logs button will allow users to clear the buffered files on meter.

The L-WEB can post data to a server at intervals of time ranging from 1 minute to 1 month.

The settings for configuring the post channels to post the data can be found by clicking on 'Settings' and then selecting 'Communications' tab. Click "Post Channels" to configure any of the three post channels.

Post Channel 1 Enable: Enable the Post Channel 1 in order to configure the settings needed to post data via the HTTP(S)/FTP post functions

Post Method: Select the method for posting the files, the user can choose HTTP/HTTPS or FTP

Post Name Fixed: This configuration needs to be enabled in order for user to control the name of the file that will be posted. Otherwise file name will be based on the Log File Name Format configuration from the Data Log settings

Post File Name: Users can enter a name for the file that will be posted as if 'Post Name Fixed' is enabled

If the HTTP/HTTPS post method is selected:

HTTP/HTTPS URL: Enter the URL for the HTTP/HTTPS server. The URL needs to begin with the prefix http:// or (https://)

HTTP/HTTPS Port: Enter the port number the server will be listening on

HTTP/HTTPS Meter ID: Enter a name or description for the meter to be identified on the server

If the FTP post method is selected:

FTP URL: Enter the URL for the FTP server. The URL needs to begin with the prefix ftp://

FTP Port: Enter the port number the server will be listening on

FTP Username: Enter the username required to log into the FTP server

FTP Password: Enter the password required to log into the FTP server

NOTE: The 'TEST Post Channel' button should only be utilized after clicking the 'Save' button otherwise a fail response will be observed. If a fail response occurs after clicking 'Save' confirm the network settings or credentials for the server.

Click 'Save' after changing any settings. Users will be prompted to reboot the L-WEB immediately or later. If later is chosen the L-WEB must be rebooted from the 'Management' page in order for the settings to take effect.

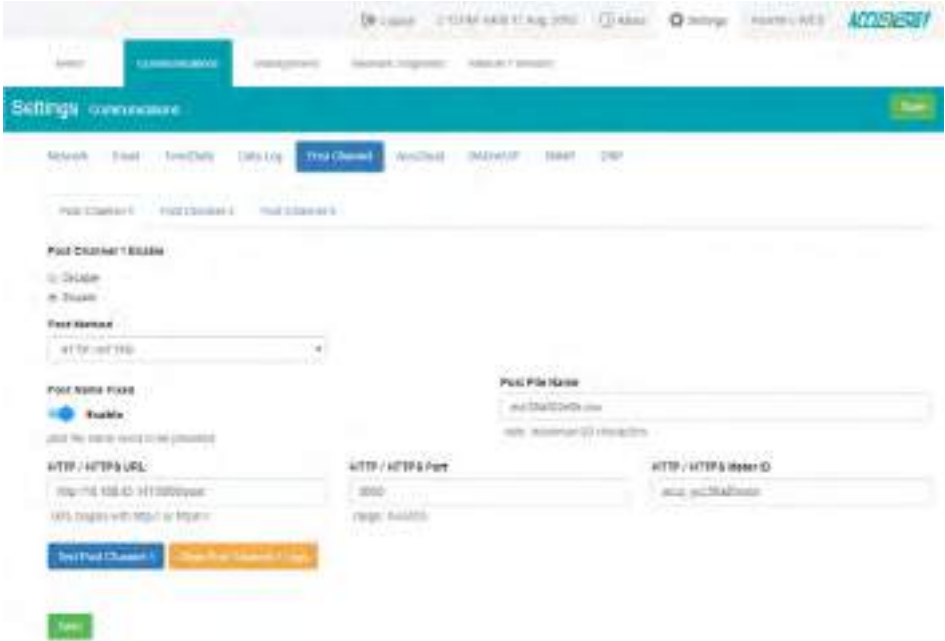

Select the Post Channel 2 tab to configure the settings for post to a second server.

Post Channel 2 Enable: Enable the Post Channel 2 in order to configure the settings needed to post data via the HTTP(S)/FTP post functions

Post Method: Select the method for posting the files, the user can choose HTTP/HTTPS or FTP

Post Name Fixed: This configuration needs to be enabled in order for user to control the name of the file that will be posted. Otherwise file name will be based on the Log File Name Format configuration from the Data Log settings

Post File Name: User can enter a name for the file that will be posted as if Post Name Fixed is enabled

If the HTTP/HTTPS post method is selected:

HTTP/HTTPS URL: Enter the URL for the HTTP/HTTPS server. The URL needs to begin with the prefix http:// or (https://)

HTTP/HTTPS Port: Enter the port number the server will be listening on

HTTP/HTTPS Meter ID: Enter a name or description for the meter to be identified on the server

If the FTP post method is selected:

FTP URL: Enter the URL for the FTP server. The URL needs to begin with the prefix ftp://

FTP Port: Enter the port number the server will be listening on

FTP Username: Enter the username required to log into the FTP server

FTP Password: Enter the password required to log into the FTP server

NOTE: The "TEST Post Channel 2" button should only be utilized after clicking the 'Save' button otherwise a fail response will be observed. If a fail response occurs after clicking 'Save' confirm the network settings or credentials for the server.

Click 'Save' after changing any settings. Users will be prompted to reboot the L-WEB immediately or later. If later is chosen the L-WEB must be rebooted from the 'Management' page in order for the settings to take effect.

The screenshot displays the 'Settings: Communications' page in the L-WEB interface. The page is divided into several sections for configuring communication channels. The 'Post Channel 2' section is currently selected and shows the following settings:

- Post Channel Enable:** A radio button selection with 'Disable' selected.
- Post Method:** A dropdown menu set to 'HTTP/HTTPS'.
- Post Name Field:** A radio button selection with 'Disable' selected.
- Post File Name:** A text input field with a placeholder 'www.energometrika.ru'.
- HTTP/HTTPS URL:** A text input field with a placeholder 'http://www.energometrika.ru'.
- HTTP/HTTPS Port:** A text input field with a value of '8080'.
- HTTP/HTTPS Meter ID:** A text input field with a value of 'test'.

At the bottom of the page, there are two buttons: 'Test Post Channel 2' and 'Test Post Channel 3'. A green 'Save' button is located at the bottom left of the page.

Select the Post Channel 3 tab to configure the settings for post to a second server.

Post Channel 3 Enable: Enable the Post Channel 3 in order to configure the settings needed to post data via the HTTP(S)/FTP post functions

Post Method: Select the method for posting the files, the user can choose HTTP/HTTPS or FTP

Post Name Fixed: This configuration needs to be enabled in order for user to control the name of the file that will be posted. Otherwise file name will be based on the Log File Name Format configuration from the Data Log settings

Post File Name: User can enter a name for the file that will be posted as if Post Name Fixed is enabled

If the HTTP/HTTPS post method is selected:

HTTP/HTTPS URL: Enter the URL for the HTTP/HTTPS server. The URL needs to begin with the prefix http:// or (https://)

HTTP/HTTPS Port: Enter the port number the server will be listening on

HTTP/HTTPS Meter ID: Enter a name or description for the meter to be identified on the server

If the FTP post method is selected:

FTP URL: Enter the URL for the FTP server. The URL needs to begin with the prefix ftp://

FTP Port: Enter the port number the server will be listening on

FTP Username: Enter the username required to log into the FTP server

FTP Password: Enter the password required to log into the FTP server

NOTE: The "TEST Post Channel 3" button should only be utilized after clicking the 'Save' button otherwise a fail response will be observed. If a fail response occurs after clicking 'Save' confirm the network settings or credentials for the server.

Click 'Save' after changing any settings. Users will be prompted to reboot the L-WEB immediately or later. If later is chosen the L-WEB must be rebooted from the 'Management' page in order for the settings to take effect.

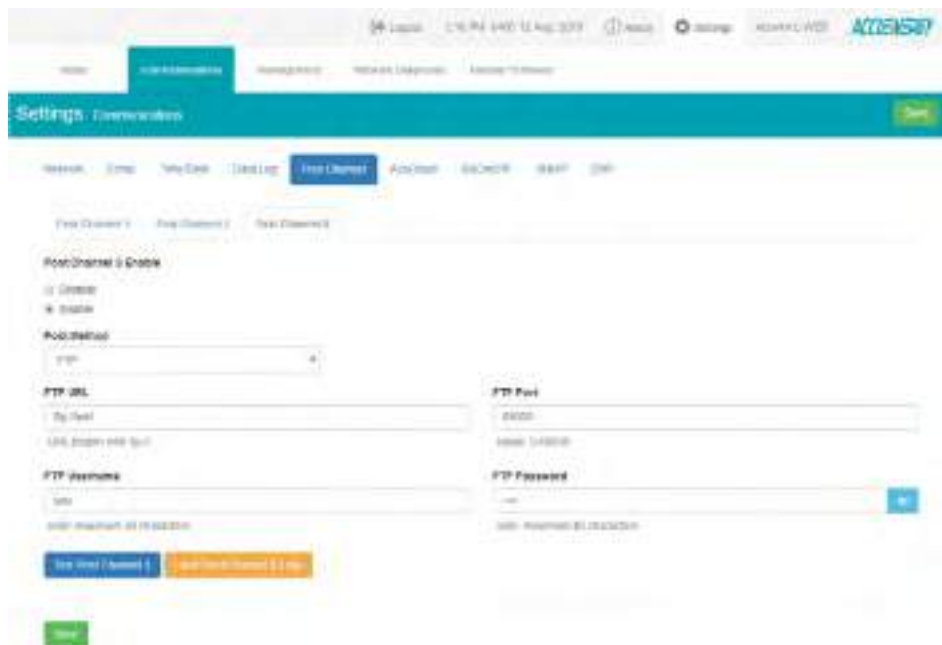

AcuCloud

The L-WEB module can directly interface with the Accuenergy Cloud software AcuCloud. The L-WEB will post data to the cloud software every five minutes.

AcuCloud will require the serial number of the L-WEB module which will then provide a token that will be used to configure the L-WEB so it can send its data to AcuCloud.

The settings for the AcuCloud post function can be found by clicking on the 'Settings' tab and selecting 'Communications'. Select 'AcuCloud' to access the settings to configure the L-WEB to send data to the cloud.

AcuCloud Enable: Select 'Enable' to enable the function and to further configure the settings related to AcuCloud.

AcuCloud Token: Copy and paste the token provided by the AcuCloud software into this field.

NOTE: The "TEST AcuCloud" button should only be utilized after clicking the 'Save' button otherwise a fail response will be observed. If a fail response occurs after clicking 'Save', please

double check the serial number entered in AcuCloud, the token pasted in the web page as well as the time and network settings of the meter.

Users can use the 'Link to AcuCloud' to access the cloud software and configure the required settings on that platform. Users must have sufficient access to add devices on their account in order to correctly configure the meter on the software. For inquiries on creating your AcuCloud account please contact Accuenergy Technical Support.

Click 'Save' after changing any settings. Users will be prompted to reboot the L-WEB immediately or later. If later is chosen the L-WEB must be rebooted from the 'Management' page for the settings to take effect.

The L-WEB will post the data continuously every 5 minutes after the reboot.



BACnet/IP

The L-WEB module supports the BACnet/IP protocol. The settings for the BACnet/IP protocol can be found on the web by clicking on the 'Settings' tab and selecting 'Communications'. Once on the communications page select "BACnet/IP" to access the settings to configure the AXM-WEB2 to communicate with a BACnet client.

BacNet Enabled: Select Enable to enable the BACnet protocol.

BACnet Port: Enter the BACnet or UDP port number. Default port is 47808.

Device Instance: Enter the instance number for the device in the BACnet system. It must be unique within the system.

Device Name: Enter a name for the device to distinguish it from other devices within the network.

The screenshot shows the 'Settings - Communications' page in the AXM-WEB2 interface. The 'BACnet/IP' tab is active. The configuration fields are as follows:

Field	Value
BACnet Device	00000
BACnet Port	47808
Device Instance	1
Device Name	Test
Latency	
Description	

Under the 'Enable Foreign Device Function' section, the 'Enable' radio button is selected.

Under the "Enable Foreign Device Function", select 'Enable' to communicate with a BACnet device from another subnet.

- Enter the IP of the BACnet Broadcast Management Device(BBMD) under the 'BBMD IP' field for the device which will receive broadcast messages on one subnet and forward them to another subnet.

- Enter BACnet Port of the BBMD in "BBMD Port"
- Enter a value between 5-1440 min in the "Time To Live" for how often the foreign device will register in the BBMD's foreign device table.

Click 'Save' after changing any settings. Users will be prompted to reboot the L-WEB immediately or later. If later is chosen the L-WEB must be rebooted from the 'Management' page in order for the settings to take effect.

Enable Foreign Device Function unsaved changes

Disable
 Enable

BBMD IP

BBMD Port

Time To Live
Enter time in minutes

[EPICS file download](#)

SNMP

The L-WEB module supports the Simple Network Management Protocol(SNMP) protocol for reporting the metering data to the management station. The L-WEB uses a public community string for read-only access. By default the module will communicate using SNMP port 161. The L-WEB also supports 'traps' to send unsolicited messages to up to four management stations.

The settings for the SNMP protocol can be found by clicking on the 'Settings' tab and selecting 'Communications'. From the communications page select the 'SNMP' tab to access the settings to configure the L-WEB for communication with a SNMP management station.

SNMP Enable: Select 'Enable' to enable the function and to further configure the settings related to the SNMP protocol.

SNMP Port: By default the SNMP Port is configured to 161. The SNMP Port can be any value from ranging from 16100 to 16199.

Read Only Community: By default the community string is Public, this configuration is similar to a password which allows only authorized users to access the meters data.

Trap Enable: Select 'Enable' so that the meter will send a message to the management station when an event is triggered. The event could be a change in Digital Input Status. The notification can then be sent to up to 4 stations.

Trap Target 1: Enter the IP address and port number of station number 1 that should be notified when there is an event.

Trap Target 2: Enter the IP address and port number of station number 2 that should be notified when there is an event.

Trap Target 3: Enter the IP address and port number of station number 3 that should be notified when there is an event.

Trap Target 4: Enter the IP address and port number of station number 4 that should be notified when there is an event.

Report Buffer Size: Enter the size of the buffer for the amount of notifications will be stored before being sent to the management station. A maximum of 30 notifications can be stored.

Report Hold Time: Enter the time in seconds for how long the notification will be in queue before it gets sent to the management station. By default, this setting is configured to 0 so the notification will be sent immediately after an event occurs. This setting could be configured from 0-30 seconds.

Click 'Save' after changing any settings. Users will be prompted to reboot the L-WEB immediately or later. If later is chosen the L-WEB must be rebooted from the 'Management' page in order for the settings to take effect.

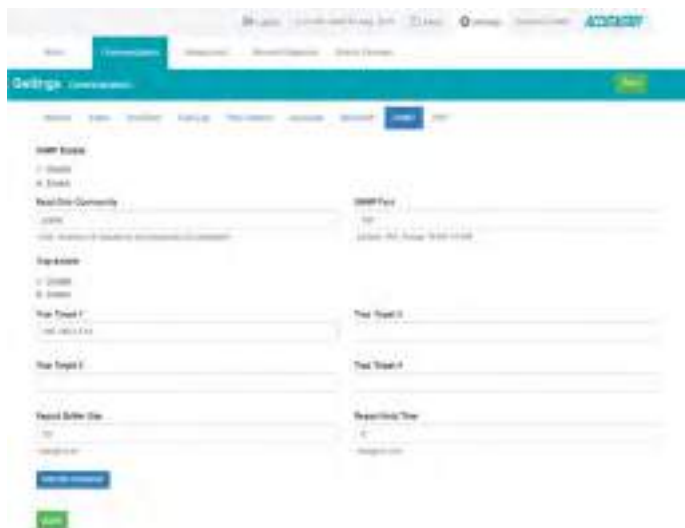

DNP

The L-WEB supports the DNP communications protocol. The Distributed Network Protocol (DNP) is an open protocol used in the electric utility industry for communication and interoperability among substation computers, Remote Terminal Units (RTUs), Intelligent Electronic Devices (e.g. meters), and master stations.

The settings for the DNP protocol can be found by clicking on the 'Settings' tab and selecting 'Communications'. Select 'DNP' to access the settings to configure the L-WEB to communicate with a DNP master.



DNP Enable: Select 'Enable' to enable the function and to further configure the settings related to the DNP function.

TCP/IP Mode: By default the TCP/IP is set as TCP&UDP, it can be changed to TCP dual endpoint mode or UDP only.

Local TCP Port: Enter the port number for the local TCP server.

Local UDP Port: Enter the port number for the local UDP server.

Destination IP address: The default IP address is set as *.*.* to allow all incoming requests.

Dual endpoint IP port: Enter the port number for the endpoint IP server.

Destination UDP port for initial unsolicited null responses: Enter the port number of the destination UDP server for the initial unsolicited null responses.

Destination UDP port for response: Enter the port number of the destination UDP server for response.

Link address: Enter the address number of the slave device.

Master link address: Enter the address number of the master device.

Source address validation: By default the validation is disabled, select 'Enable' to enable the destination address validation.

Supports Unsolicited Reporting: Select 'Enable' to enable the function and further configure the settings related to the unsolicited report.

Number of Unsolicited Retries: Number of retries can be selected as '0', '10' and 'infinite'.

Unsolicited response trigger Condition(Num of class # events): Enter the number of events for each class to setup the trigger point. The unsolicited response will be triggered once the number the class events reaches the configured triggering number. The range is from 0-255.

Unsolicited response trigger Condition(Hold time after class # events): Enter the threshold holding time for each class, the unsolicited response will be triggered once the event holding time is longer or equal to the threshold time. The range is from 0-86400000 milliseconds.

Support for broadcast functionality: In DNP there three broadcasting addresses that are supported. Enabling this setting would allow the module to respond to requests (from the client) sending them to the broadcasting addresses.

DNP3 Point Configuration

Users can assign certain parameters to either class 1, class 2 or class 3.

The scale factor is a multiplier that can be applied to a certain parameter when viewing the readings.

An offset can be applied to the reading.

The dead band can be set for each parameter, where if the value of the parameter exceeds the dead band value a DNP event will occur.

DNP3 Point Configuration

		Class 1	Class 2	Class 3	Scale Factor	Scale Offset	Deadband
1	Phase A Line-to-Line Voltage	01	01	01	1	0	0
2	Phase B Line-to-Line Voltage	02	02	02	1	0	0
3	Phase C Line-to-Line Voltage	03	03	03	1	0	0
4	Phase A Line-to-Line Voltage	01	01	01	1	0	0
5	Phase B Line-to-Line Voltage	02	02	02	1	0	0
6	Phase C Line-to-Line Voltage	03	03	03	1	0	0
7	Phase A Line-to-Line Voltage	01	01	01	1	0	0
8	Phase B Line-to-Line Voltage	02	02	02	1	0	0
9	Phase C Line-to-Line Voltage	03	03	03	1	0	0
10	Phase A Line Current	01	01	01	1	0	0
11	Phase B Line Current	02	02	02	1	0	0
12	Phase C Line Current	03	03	03	1	0	0
13	System Neutral Current	00	00	00	1	0	0
14	Total Line Current	04	04	04	1	0	0
15	Phase A Active Power	01	01	01	1	0	0
16	Phase B Active Power	02	02	02	1	0	0
17	Phase C Active Power	03	03	03	1	0	0
18	System Active Power	00	00	00	1	0	0
19	Phase A Reactive Power	01	01	01	1	0	0

Users can use the 'Batch Modify' button to apply certain settings to all parameters instead of individually configuring each point. Once the configuration in the batch modify is complete click on 'save changes'.



After all DNP settings are complete, click on 'Save'. Users will be prompted to reboot the L-WEB immediately or later. If later is chosen the L-WEB must be rebooted from the 'Management' page in order for the settings to take effect.

Management

Parameter Reset

The Management web page allows the user to clear and reset certain parameters in the meter.

The following parameters can be reset from the Management page:

- Demand
- Energy
- Max and Min
- Alarm Record
- Device Up Time
- Load Run Time

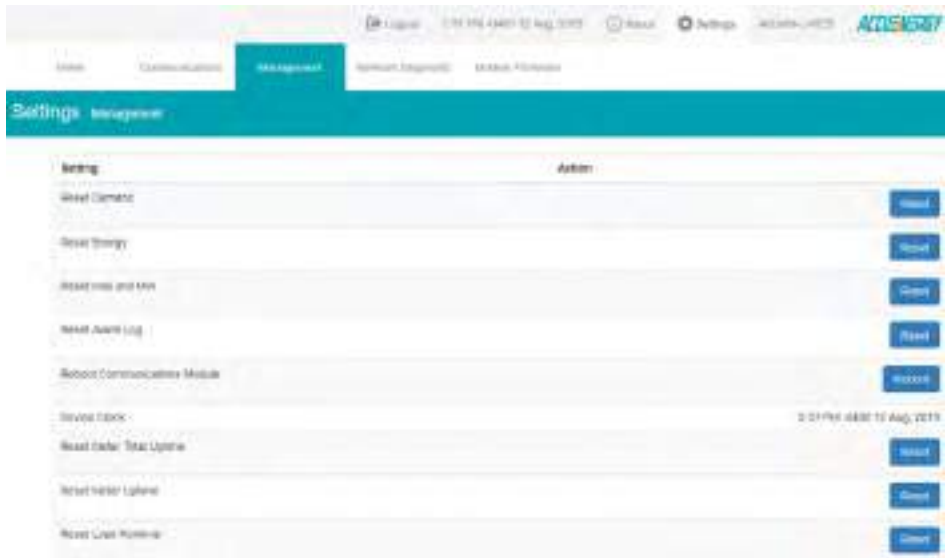

Module Reboot

Users can also reboot the web module which is required after any communication or meter setting is changed, if a module reboot is not performed the settings will not be saved to the meter and will go back to its default settings.

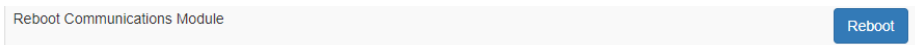

Change Password

The access level passwords can be changed from the Management page as well, all new passwords must be 6 characters or more.

Reset Admin Password	<input type="text" value="Enter old password"/>
	<input type="text" value="Enter new password"/>
	<input type="checkbox"/> Show password
	<input type="button" value="Save"/>
Reset View Password	<input type="text" value="Enter old password"/>
	<input type="text" value="Enter new password"/>
	<input type="checkbox"/> Show password
	<input type="button" value="Save"/>

SSH

The L-WEB module supports the SSH which can be enabled to allow users to remotely log into the meter using the SSH protocol. When enabled the status will show 'On', when disabled the status will show 'Off'.

SSH current status: Off	<input type="button" value="Enable"/>
----------------------------	---------------------------------------

Debug Diagnostic

The debug diagnostic allows the user to enable or disable the debug logs. The current status will say 'All off' if disabled, 'All On' if enabled..

Debug Diagnostic current status: All Off Link to advanced settings	<input type="button" value="Enable"/>	<input type="button" value="Disable"/>
---	---------------------------------------	--

Users can click on the advanced link, to turn on or off specific debug logs. If certain debug logs are enabled the current status will show 'Partial On'.



NOTE: The system performance may be affected by enabling the debug logs.

Diagnostic File

There is a diagnostic file on the L-WEB module that users can download which can be used to analyze the modules diagnostics.

NOTE: Please send the diagnostic file to Accuenergy Technical Support (support@accuenergy.com) for analysis.



Network Diagnostic

The Network Diagnostic page can be used to monitor the network status of the module.

The screenshot shows the 'Network Diagnostic' page in the EnergySight web interface. The page is divided into several sections:

- Ethernet Network:** Displays network configuration for two interfaces, 'enp0s8' and 'enp0s9'. Each interface shows details like IP address, netmask, gateway, and DNS servers.
- Routing Table:** Shows a table of routing entries. The table has columns for 'Destination', 'Gateway', 'Genmask', 'Flags', 'Metric', 'Use', and 'Iface'.
- DNS Server:** Lists the DNS servers configured for the system.
- Network List:** Provides a detailed list of network routes, including destination, gateway, metric, and interface.

The interface includes navigation tabs at the top: 'Main', 'Communications', 'Management', 'Network Diagnostic', and 'Module Parameters'. The 'Network Diagnostic' tab is currently selected.

In the 'Host Lookup' tab users can utilize the 'ping' function to test the reach-ability to other networks.



User can also use the 'Connection Test' function to test the local network that the module connected to. The test result will show SUCCESS and PASS if there is no issues found.



Module Firmware Update

The Module Firmware web page is used for updating the firmware version on the L-WEB module. The user can check if the module they are using is up to date and update the module if needed using the remoter firmware update. Users can also manually update the firmware by uploading the firmware file. The current version of the firmware will be displayed on the Module firmware update page and can also be viewed on the 'Device Information' page of the web interface.

NOTE: Users can also contact Accuenergy Technical Support for latest firmware.

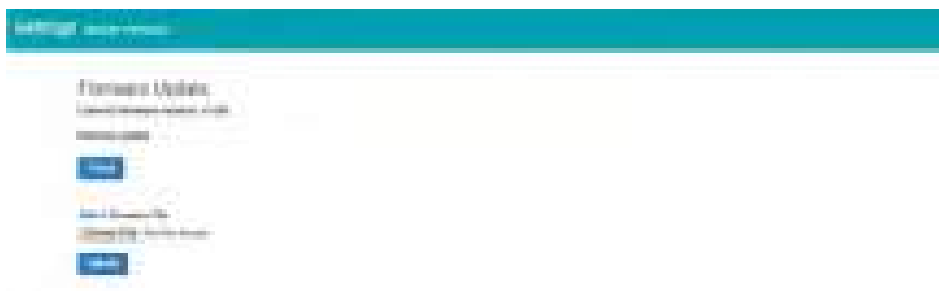

Manual Update

Select and upload the L-WEB firmware file, it is a .aup file extension.



Once the upload was successfully uploaded you will see the following page confirming that the file was uploaded.



Click 'Process' to begin the update.



L-WEB will start to reboot when the firmware update is complete. Wait for 1-2 minutes to complete the reboot.



Remote Update

Users can also use the remote firmware server to update the module firmware. Click on 'Check' to verify if there is a firmware update available.



If there is an update available, users can proceed to download the firmware.



Once the download is complete, the updating process will begin.



When the firmware update is complete, the module will reboot. The rebooting process will take 1-2 minutes to complete.

After the module reboots, users will be able to log back into the web interface. When logged in click on the 'About' tab located on the top right corner of the web page to view the 'Device Information' page. From the Device Information page users can ensure that the meter was updated correctly to the right firmware version.



ЭНЕРГОМЕТРИКА
www.energometrika.ru

ООО «Энергометрика»
zakaz@energometrika.ru
www.energometrika.ru
+7(495) 276-0510