

TEMPERATURE LIMITER

RL10



Table of contents:

1. Application.....	3
2. Limiter set	3
3. Basic requirements, operational safety	3
4. Assembly	4
5. Starting operation	7
6. Operation	9
7. Input and output of the temperature limiter	12
8. Output working modes	13
8. Additional functions	14
9. RS-485 interface with MODBUS protocol	15
10. Configuring parameters using eCon.....	17
11. Error reporting	18
12. Technical data	19
13. Limiter ordering code.....	21

1. Application

The RL10 temperature limiter is designed for use wherever there is a need for monitoring of heating processes and the systems used must be safe in the event of any failure. If the permissible temperature limit is exceeded or a temperature sensor fault occurs (sensor short / open), the temperature limiter RL10 will switch off the object. The RL10 works directly with resistive or thermoelectric sensors.

2. Limiter set

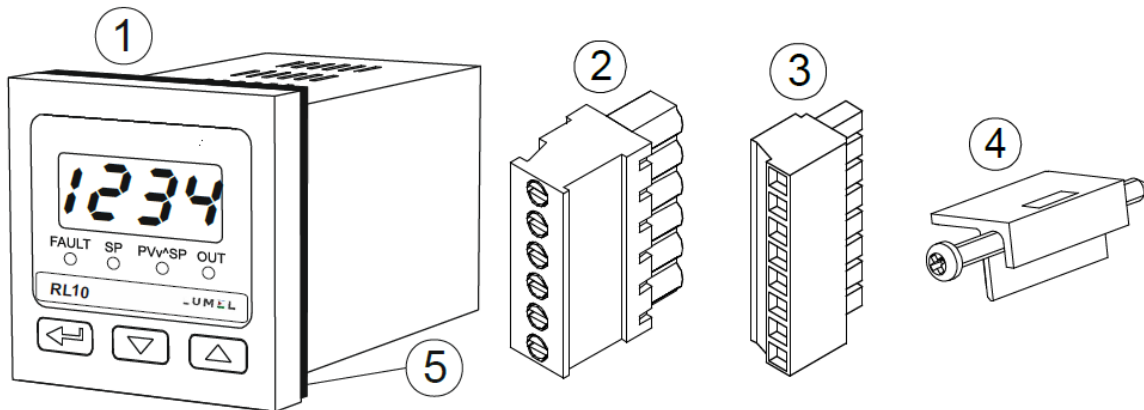

Complete set of the Limiter includes:

- | | |
|--|-------|
| 1. temperature limiter..... | 1 pc. |
| 2. connector with 6 screw terminals | 1 pc. |
| 3. connector with 8 screw terminals | 1 pc. |
| 4. mounting brackets to fix the device in the panel..... | 4 pc. |
| 5. gasket..... | 1 pc. |
| 6. User's Manual | 1 pc. |

3. Basic requirements, operational safety

In terms of operational safety the limiter meets the requirements of EN 61010-1.

Safety instructions:



- The assembly and the installation of electrical connections may be carried out only by a duly qualified electrician.
- Always check the connections before powering the limiter on.
- Prior to removing the limiter housing, always turn the power supply off and disconnect the measurement circuits.
- Removal of the limiter housing during the warranty period voids the warranty.
- The device is intended for installation and use in industrial electromagnetic environments.
- A switch or a circuit-breaker should be installed in the building or facility. It should be located near the device, easily accessible to the operator, and suitably marked.

4. Assembly

4.1. Installation of the limiter

Fix the temperature limiter to the panel with four mounting brackets with screws according to Fig. 1. The hole in the panel should have dimensions of $45^{+0,6} \times 45^{+0,6}$ mm. The thickness of the material from which the panel is made must not exceed 15 mm.

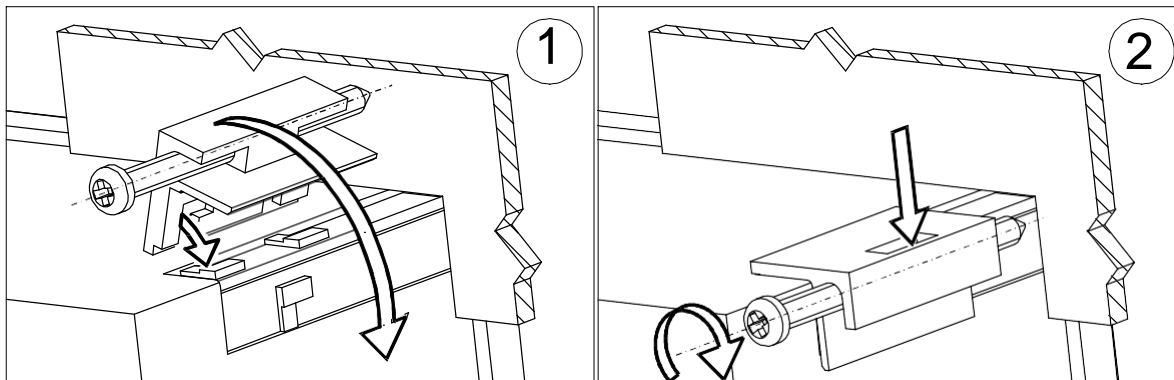

Fig. 1: Fixing the temperature limiter.

Dimensions of the temperature limiter are shown in Figure 2.

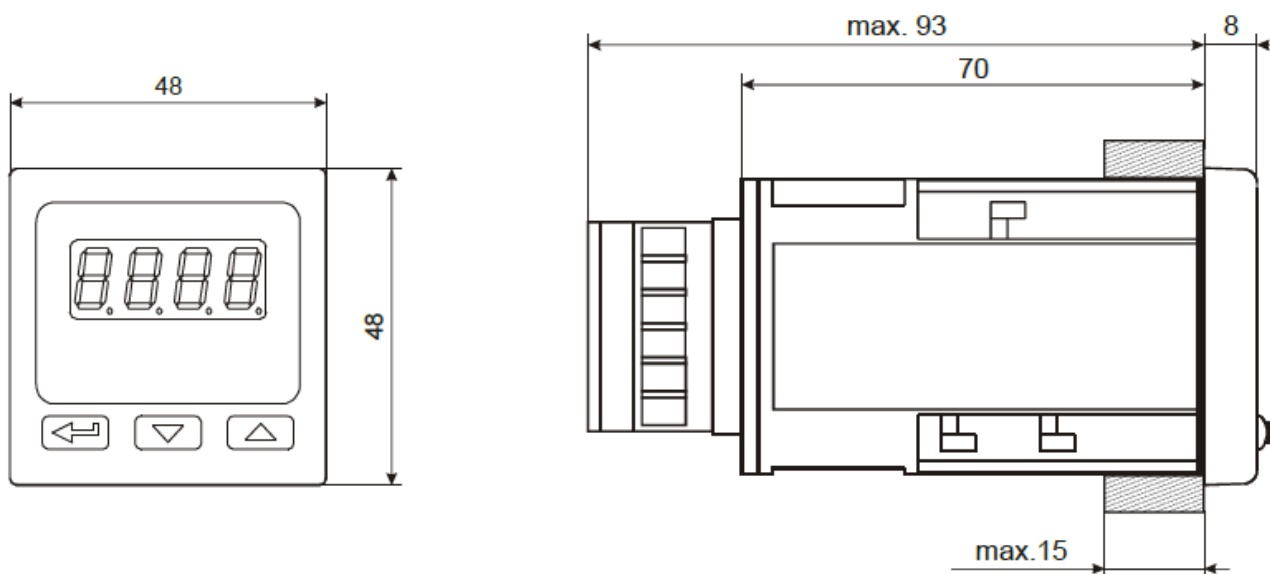

Fig. 2: Dimensions of the temperature limiter

4.2. Electrical connections

The temperature limiter has two detachable connectors with screw terminals. One connector allows for connection of power and output with a conductor cross-section up to 2.5 mm^2 , the other connector allows connection of input signals through a conductor up to 1.5 mm^2 .

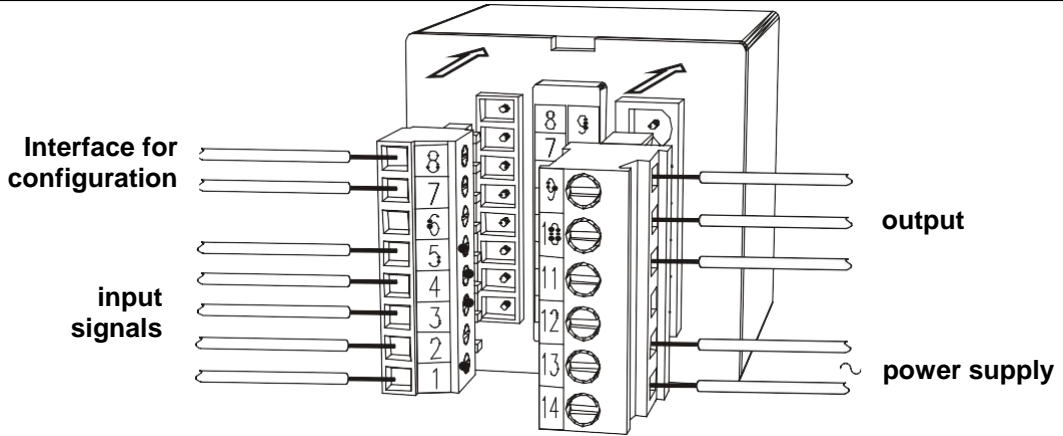

Fig. 3: View of the temperature limiter connectors.

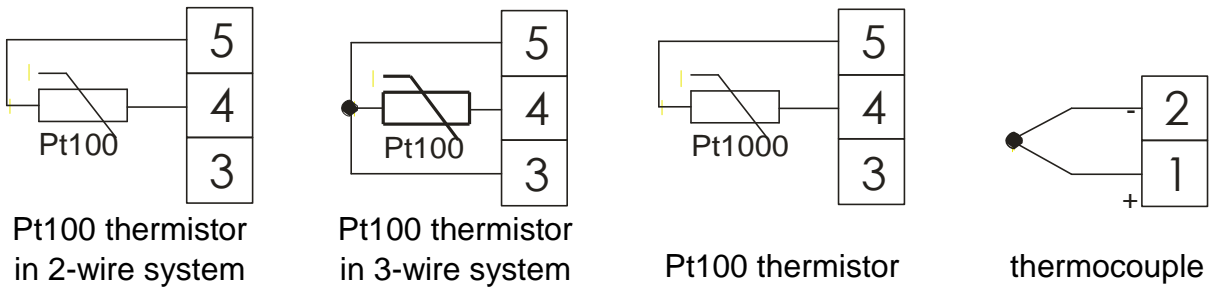

Fig. 4: Input signals

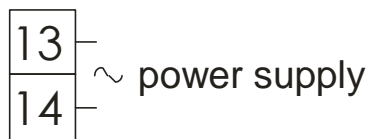

Fig. 5: Power supply

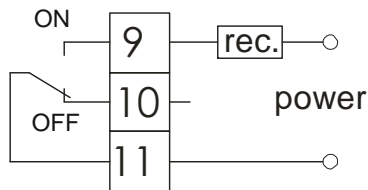

Fig. 6: Limiter output

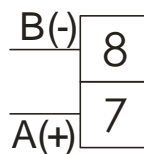

Fig. 7: RS-485 interface (configuration only)

4.3. Installation guide

In order to obtain full resistance of the temperature limiter to electromagnetic interference, the following rules should be observed:

- do not power the temperature limiter from the mains near devices producing impulse interference and do not use common grounding circuits with such devices,
- use network filters,
- test leads shall be twisted in pairs and shielded, and for thermistors in a three-wire connection they should be twisted from wires of the same length, cross-section and resistance and shielded,
- all shielding should be earthed or connected to the protective conductor, on one side, as close as possible to the temperature limiter,
- apply the general rule that the different signal conductors should be routed as close as possible to each other (no less than 30 cm), and the crossing of these harnesses is performed at an angle of 90°.

5. Starting operation

Description of temperature limiter

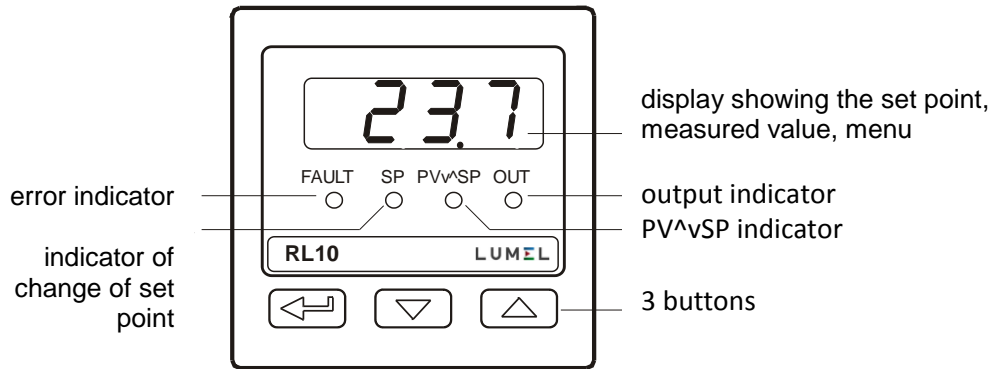

Fig. 8: Front panel of the temperature limiter.

Powering on

When the power is turned on, the temperature limiter performs the display test, displays **RL 10**, the program version, and then displays the set point.

The display may show a character message informing you of abnormalities, see table 9).

LED indicators



FAULT - (error indicator) Enabled when:

- temperature limiter conditions are met, i.e. the temperature limit is exceeded (see fig. 13) OR
- a temperature sensor error (sensor short / open) will occur.

The algorithm to disable the error indicator (transition to normal operating state) depends on the limitation maintaining function ($L.L.t = OFF$).

When limitation maintaining is inactive ($L.L.t = OFF$), FAULT indicator is disabled when:

- temperature limiter conditions have ceased to exist, i.e. the temperature limit is not exceeded (see fig. 13) AND
- there is no temperature sensor error (sensor short / open); When the limitation maintaining is active ($L.L.t = ON$) FAULT indicator is deactivated when:

- temperature limiter conditions have ceased to exist, i.e. the temperature limit is not exceeded (see fig. 13) AND
- there is no temperature sensor error (sensor short / open) AND
- there has been reset of the limitation maintaining by simultaneous pressing the  and  button for 2 sec.

The FAULT indicator takes the opposite state to the OUT indicator.

SP - (indicator of set point change) enabled during the change of **SP** set point.

- PV v[^] SP** - (indicator of correct status) enabled when the operation status is correct, i.e.:
- for the limiter of too high temperature (**out = L.H.**), when the measured value **PV** is lower than the **SP** set point.
 - for the limiter of too high temperature (**out = L.L.**), when the measured value **PV** is greater than the **SP** set point.

OUT - (output indicator) indicates the status of the limiter output, the indicator is on when limiter output is active (ON state at the output); the Indicator off when limiter output is inactive (OFF state at the output).

Output is disabled when:



- temperature limiter conditions are met, i.e. the temperature limit is exceeded (see fig. 13) OR
- a temperature sensor error (sensor short / open) will occur.

The algorithm to disable the output (transition to normal operating state) depends on the limitation maintaining function (**L.L.**).

When limitation maintaining is inactive (**L.L. = OFF**), the output is enabled when:

- temperature limiter conditions have ceased to exist, i.e. the temperature limit is not exceeded (see fig. 13) AND
- there is no temperature sensor error (sensor short / open); When the limitation maintaining is active (**L.L. = ON**) the output is

enabled when:



- temperature limiter conditions have ceased to exist, i.e. the temperature limit is not exceeded (see fig. 13) AND
- there is no temperature sensor error (sensor short / open) AND
- there has been reset of the limitation maintaining by simultaneous pressing  and  buttons for 2 sec.

The OUT indicator takes the opposite state to the FAULT indicator.

View of the measured value.

Values measured by the temperature limiter and temperature controller can be measured at different locations, and this leads to different indications. To avoid confusion for the end customer, the measured value is not shown on the display permanently. The measured value is displayed by pressing the  button.

Change of set point

By default, the display shows the SP setpoint. Change the setpoint is done by pressing and holding  and  button for 5 sec. Start of setpoint change is indicated by a flashing dot on the display and the SP LED. The new setpoint must be approved with the  or it will be accepted automatically after 1 minute since the last pressing of the button.

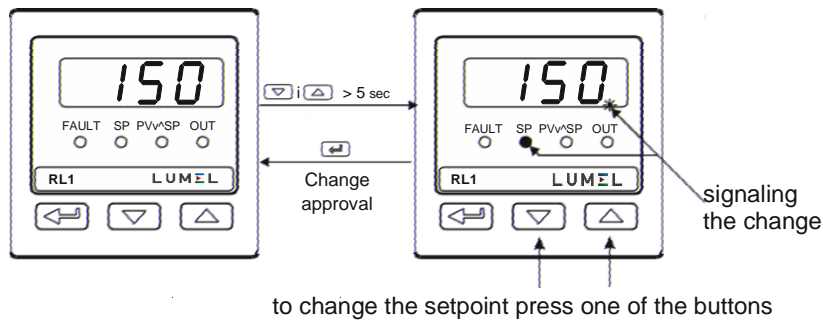

Fig. 9: Change of set point

6. Operation

The operation of the controller is shown in Figure 10.

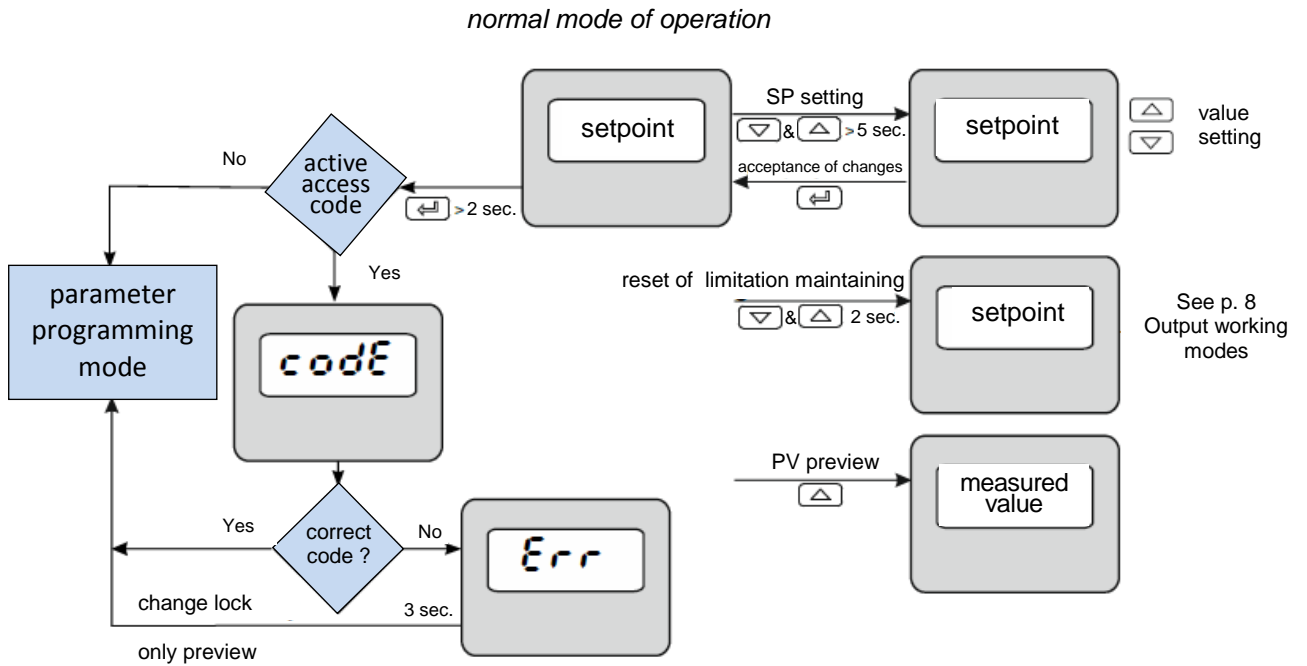

Fig. 10: Temperature limiter operating menu

6.1. Programming temperature limiter parameters

Pressing and holding for about 2 seconds the button moves the user to the programming matrix. The programming matrix can be protected by an access code. If you enter an invalid code value, you can only view the settings without changing them.

Figure 11 shows the transition matrix in programming mode. The transition between parameters is done with or buttons. In order to change the parameter setting, proceed according to 6.3. To exit the programming menu, switch between parameters until [. . .] and symbol appears and press button or simultaneously two buttons and .

Some parameters may not be visible - this depends on the current configuration. Description of parameters can be found in table 1. The return to normal operation is automatic after 30 seconds since the last key press.

6.1. Programming matrix

Unit	Input type	Line type	Decimal point position	Measured value offset	Output configuration
Deviation from SP setpoint	Hysteresis of the limiter output	Limitation maintaining	lower limit of SP setpoint	upper limit of SP setpoint	Address of the limiter
Transmission speed	Transmission protocol	Access code	...		

Fig. 11: Programming matrix

6.2. Change of setting

Changing the parameter setting starts when you press the button while displaying the parameter name. Using buttons and the setting is selected, and using button the setting is accepted. To cancel a change press simultaneously buttons and or automatically after 30 seconds since the last press of the button. The way of changing the setting is shown in Fig. 12.

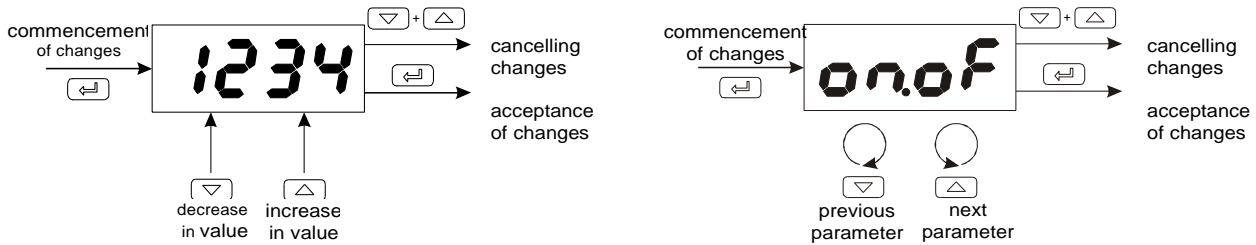

Fig. 12: Changing numeric and text parameter settings.

6.3. Parameter description

The list of parameters in the menu is shown in Table 1.

List of configuration parameters

Table 1

Parameter symbol	Parameter description	Factory setting	Range of parameter changes
<i>u n i t</i>	Unit	<i>°C</i>	<i>°C</i> : degrees Celsius <i>°F</i> : degrees Fahrenheit
<i>i n t y</i>	Type of input	<i>Pt 1</i>	<i>Pt 1</i> : Pt100 <i>Pt 10</i> : Pt1000 <i>t - J</i> : thermocouple type J <i>t - T</i> : thermocouple type T <i>t - K</i> : thermocouple type K <i>t - S</i> : thermocouple type S <i>t - R</i> : thermocouple type R <i>t - B</i> : thermocouple type B <i>t - N</i> : thermocouple type N
<i>t - L</i>	Line type for Pt100 sensor	<i>3 - P</i>	<i>2 - p</i> : two-wire <i>3 - p</i> : three-wire
<i>d P</i>	Decimal point position	<i>1 - d P</i>	<i>0 - d P</i> : no decimal place <i>1 - d P</i> : 1 decimal place
<i>S h i F</i>	Measured value offset	0,0 °C (0,0 °F)	-100,0...100,0 °C (-180,0...180,0 °F)
<i>o u t</i>	Output configuration	<i>L . H</i>	<i>L . H</i> : limitation of too high temperature <i>L . L o</i> : limitation of too low temperature
<i>L . d u</i>	Deviation from SP setpoint	2,0 °C (3,6 °F)	-200,0...200,0 °C (-360,0...360,0 °F)
<i>L . H y</i>	Hysteresis of the limiter output	1,0 °C (1,8 °F)	0,2...100,0 °C (0,2...180,0 °F)
<i>L . L t</i>	Maintaining limitation (see p. 8. Output modes)	<i>o n</i>	<i>o f f</i> : disabled <i>o n</i> : enabled
<i>S P L</i>	Lower limit of SP setpoint	-200,0 °C (-328,0 °F)	MIN...MAX ¹⁾
<i>S P H</i>	Upper limit of SP setpoint	850,0 °C (1562,0 °F)	MIN...MAX ¹⁾
<i>A d d r</i>	Address of the device	1	1...247
<i>b R u d</i>	Transmission speed	<i>9 6</i>	<i>4 8</i> : 4800 bit/s <i>9 6</i> : 9600 bit/s <i>1 9 2</i> : 19200 bit/s
<i>P r o t</i>	Protocol	<i>r 8 n 2</i>	<i>r 8 n 2</i> : RTU 8N2 <i>r 8 E 1</i> : RTU 8E1 <i>r 8 o 1</i> : RTU 8O1 <i>r 8 n 1</i> : RTU 8N1

SECU	Access code ²⁾	0	0...9999
-------------	---------------------------	---	----------

¹⁾ See Table 2.

²⁾ Hidden parameter in read-only parameter viewing mode.

Measuring ranges for inputs

Table 2

Input / Sensor	MIN		MAX	
	°C	°F	°C	°F
Pt100 thermistor	-200 °C	-328 °F	850 °C	1562 °F
Pt1000 thermistor	-200 °C	-328 °F	850 °C	1562 °F
Thermocouple type J	-50 °C	-58 °F	1200 °C	2192 °F
Thermocouple type T	-50 °C	-58 °F	400 °C	752 °F
Thermocouple type K	-50 °C	-58 °F	1372 °C	2501.6 °F
Thermocouple type S	0 °C	32 °F	1767 °C	3212.6 °F
Thermocouple type R	0 °C	32 °F	1767 °C	3212.6 °F
Thermocouple type B	200 °C	392 °F	1767 °C	3212.6 °F
Thermocouple type N	-50 °C	-58 °F	1300 °C	2372 °F

7. Input and output of the temperature limiter

7.1. Measuring inputs

The measuring input is the source of the value measured for the alarm. The input is universal and can be used to connect Pt100, Pt1000 sensors or thermocouples.

In the first place set the unit of temperature display with the **UNIT** parameter. Unit change sets factory defaults for parameters whose range is different for Celsius and Fahrenheit.

The input signal type is selected with the **TYPE** parameter.

For the Pt100 thermistor, select the **TYPE** connection type - between two-wire and three-wire. In a three-wire connection of Pt100, line resistance compensation is automatic.

For thermocouples the cold end temperature compensation is automatic.

An additional parameter is the decimal point position, which determines the display format of the measured and set value (**DP** parameter). Correction of the measured value display is done with the **SHIFT** parameter.

7.2. Exit

The temperature limiter has one output with a maximum load of 5 A / 230 V a.c.

8. Output working modes

To configure the output of the limiter, set the **out** parameter to one of the available limitation types (**Li.H** or **Li.Lo**). Both types of limitation are shown in Figure 13.

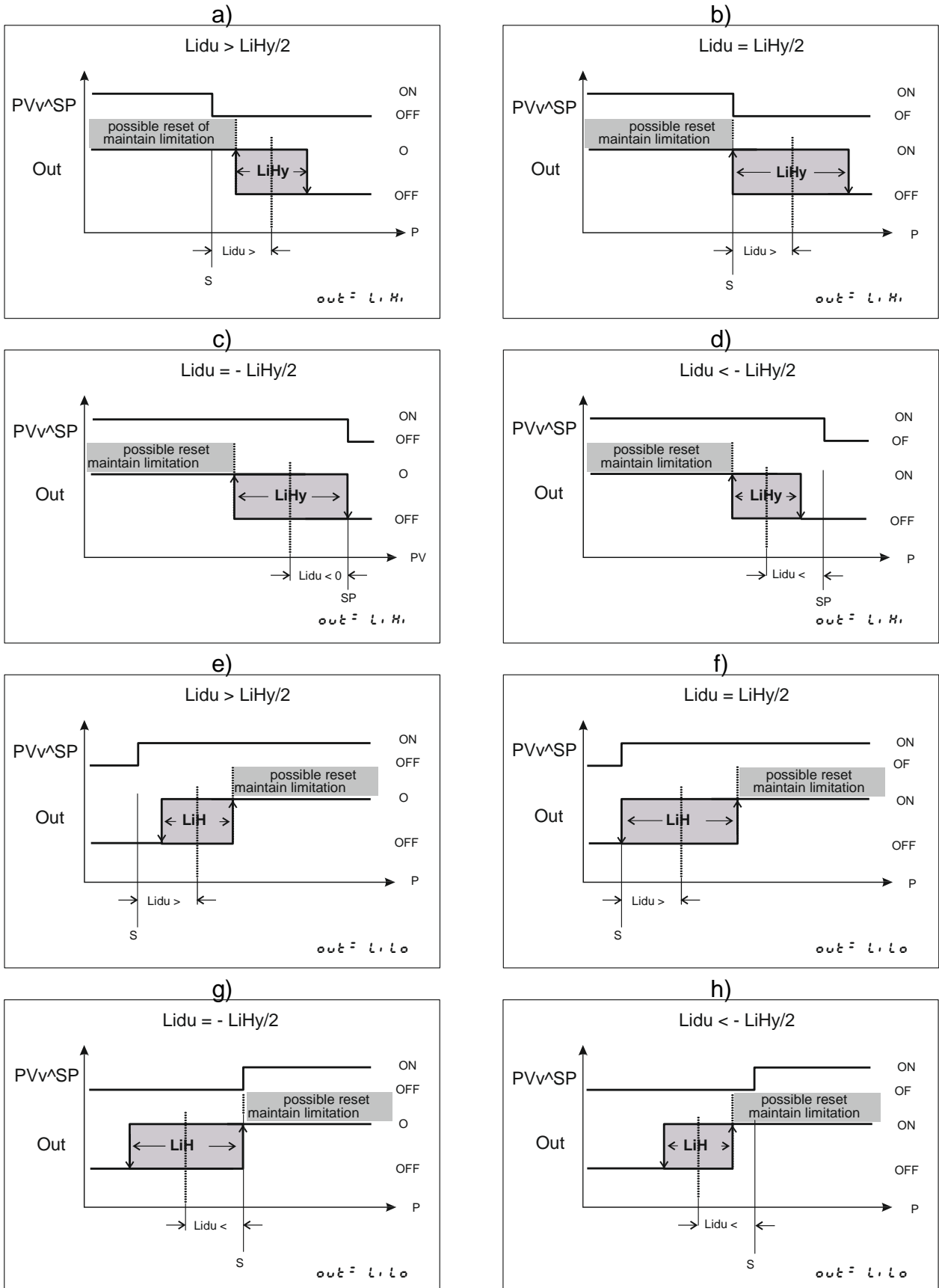

Fig.13 Working modes of the limiter output

Reset of limitation maintaining

You can set limitation status lock, that is saving the output status (disable- OFF) and OUT indicators status (enabled) and FAULT (enabled) when limiting conditions are no longer present (parameter $L.Lt = on$). Reset of limitation maintaining can be done by simultaneously pressing buttons \square and \square for about 2 seconds in normal operation. Reset of limitation maintaining is only possible after the limitation conditions are no longer present, see Fig. 13. The **FAULT** indicator turns off, **OUT** indicator turns on and the output is enabled (ON status at the output).

Limiting too high temperature - settings ($out = L.H$).

Example

Setpoint SP = 200°C. Turning off the furnace at 225°C with activated lock of automatic reclosing of the furnace. It is possible to manually switch on the furnace when the temperature drops below 205°C.

Set up (Fig 8a):

output type $out = L.H$
 deviation from setpoint: $L.du = 15$
 hysteresis: $L.HY = 20$
 maintaining limitation (lock of automatic reclosing). $L.Lt = on$

Set up (Fig 8b):

output type $out = L.H$
 deviation from setpoint: $L.du = 12.5$
 hysteresis: $L.HY = 25$
 maintaining limitation (lock of automatic reclosing). $L.Lt = on$

Limiting too low temperature - settings ($out = L.Lo$).

Example (Figure 8e)

Setpoint SP = 50°C. Switching on the cooling if the temperature rises above 60°C with shutdown of cooling when the temperature drops below 55°C.

You need to set:

output type $out = L.Lo$
 deviation from setpoint: $L.du = 7.5$
 hysteresis: $L.HY = 5$
 maintaining limitation (lock of automatic reclosing). $L.Lt = off$

8. Additional functions

8.1. Factory settings

Factory settings can be restored by pressing buttons \square and \square until the display shows **FRbr**.

9. RS-485 interface with MODBUS protocol

9.1. Introduction

The RL10 temperature limiter is equipped with RS-485 serial interface with MODBUS asynchronous communication protocol implemented. The interface only serves to configure the limiter before you start its operation.

You can use free eCon software to perform configuration (see point 10. Configuring parameters using eCon).

The list of serial interface parameters of the RL10 limiter:

- device address: 1,
- baud rate: 9600 bit/s,
- operating modes: RTU,
- Information unit: 8N2,
- data format: integer (16 bit),
- maximum response time: 500 ms,
- maximum number of registers read / written with one command: 32.

The RL10 limiter performs the following protocol functions:

Table 3

Code	Meaning
03	readout of n-registers
06	record of 1 registry
16	record of n-registers
17	slave device identification

8.1. Error codes

If the temperature limiter receives a query with a transmission or a checksum error, such query will be ignored. For a valid query but with incorrect value, the temperature limiter will send a response containing an error code.

Table 4 shows possible error codes and their meaning.

Error codes

Table 4

code	meaning	cause
01	forbidden function	the function is not supported by the limiter
02	forbidden data address	the registry address is out of range
03	forbidden value of the data	the registry value is out of range or the registry is read-only

8.2. Map of registers

The temperature limiter stores data in 16-bit registers. The list of write and read registers is shown in Table 5. "R-" operation means readability, and "RW" operation means possibility to read and write.

Map of registers from address 4000

Table 5

Register address	Marking	Operations	Parameter range	Description
4000		-W	1	Command register 1 – restore factory settings (except interface and defined programs settings)
4001		R-	100...999	Program version number [x100]
4002		R-	1606...9999	Older 4 digits of serial number
4003		R-	1...9999	Younger 4 digits of serial number
4004		R-	0...0xFFFF	Limiter status – description in Table 6
4005		R-	0...0xFFFF	Error log – description in Table 7
4006		R-	acc. to Table 8	Measured value PV
4007		R-	acc. to Table 8	Setpoint SP
4009	UNIT	RW	0...1	Unit 0 – degrees Celsius 1 – degrees Fahrenheit
4010	INPT	RW	0...8	Main input type: 0 – thermistor Pt100 1 – thermistor Pt1000 2 – thermocouple type J 3 – thermocouple type T 4 – thermocouple type K 5 – thermocouple type S
4011	T-LI	RW	0...1	Line type 0 – two wire 1 – three wire
4012	DP	RW	0...1	Position of decimal point of main input 0 – without decimal point 1 – 1 decimal place
4013	SHIF	RW	-1000...1000 [x10 °C]	Shift of the measured value of the main input
4014	OUT	RW	0...1	Output function 0 – limiting too high temperature 1 – limiting too low temperature
4026	LIDV	RW	-1800...1800 [x10 °C]	Deviation from SP setpoint
4027	LIHY	RW	2...1000 [x10 °C] 2...1800 [x10 °F]	Hysteresis for output
4028	SPL	RW	acc. to Table 8	Lower limit for quick change of setpoint
4029	SPH	RW	acc. to Table 8	Upper limit for quick change of setpoint
4030	SECU	RW	0...9999	Menu access code
4031		RW R R R R R	LILT REL LED: FAULT LED: SP LED: PV ^v SP LED: OUT	bit 0 = LILT maintaining limitation (0 - off., 1 - on) bit 1 = always 1 bit 2 = LED FAULT (0 - correct state, 1 - error) bit 3 = LED SP (0 - SP set, 1 - setting SP) bit 4 = LED PV ^v SP (0 - incorrect state, 1 - correct state) bit 5 = LED OUT (0 - relay off, 1 - relay on)

Register 4004 – limiter status

Table 6

bit	description
0-12	Reserved
13	Output status: 0 – off, 1 – on
14	Measured value outside the measurement range
15	Controller error – check error log

Register 4005 – error log

Table 7

bit	description
0-14	Reserved
15	Uncalibrated input

Input ranges

Table 8

sensor type	range	
	UNIT = °C [x10]	UNIT = °F [x10]
Pt100	-2000...8500	-3280...15620
Pt1000	-2000...8500	-3280...15620
Fe-CuNi (J)	-500...12000	-580...21920
Cu-CuNi (T)	-500...4000	-580...7520
NiCr-NiAl (K)	-500...13720	-580...25016
PtRh10-Pt (S)	0...17670	320...32126
PtRh13-Pt (R)	0...17670	320...32126
PtRh30-PtRh6 (B)	2000...17670	3920...32126
NiCrSi-NiSi (N)	-500...13000	-580...23720

9. Configuring parameters using eCon

The limiter allows for remote configuration of parameters from PC using eCon software. Free eCon software and update files are available at www.lumel.com.pl. To configure the limiter parameters, a USB-to-PC RS485 converter is required, e.g. PD10 converter.

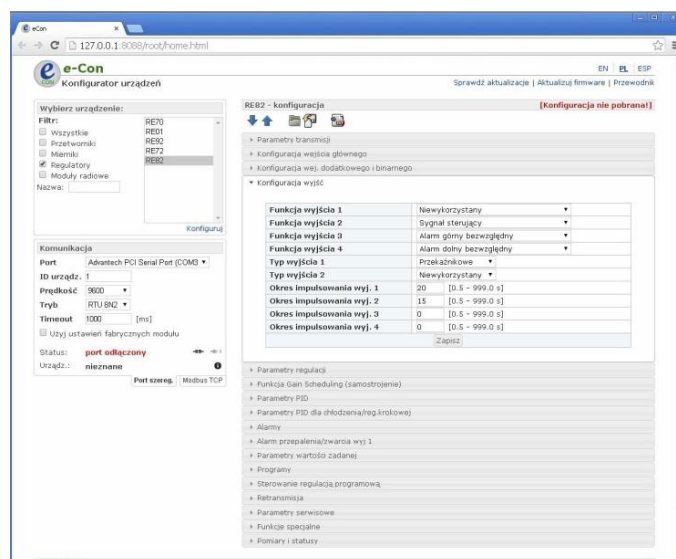



Fig.14, eCon window view

After starting eCon the serial port, speed, mode and limiter address should be set in the *Communication* window. Then select the RL10 limiter in the *Select Device* window and click the connect icon in the *Communication* window and then the  icon to read all the set parameters. Save the changed parameters by clicking the *Save* icon or  *Send configuration to the device*.



Caution!

eCon software does not allow you to upgrade the limiter software (firmware) from your PC. Firmware updates can only be made by the manufacturer.

10. Error reporting

Character messages indicating abnormal operation of the limiter

Table 9

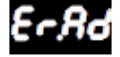
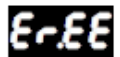
Error code	Cause	Procedure
	Exceeding measuring range down or absence of thermistor	Verify that the input signals are within the correct range - if so, check if there is not a short circuit in the thermistor resistor or if the thermocouple circuit has not been reversed.
	Exceeding measuring range up or a break in sensor circuit	Verify that the input signals are within the correct range - if so, check if there is not a break in the sensor circuit.
	Uncalibrated input	Reconnect the power supply to the limiter when it does not help, contact the nearest service.
	Configuration parameter checksum error	Reconnect the power supply to the limiter when it does not help, contact the nearest service.

11. Technical data

Input signals acc. to Table 10

Input signals and measuring ranges for inputs

Table 10

Sensor type	Standard	Designation	Range	
Pt100	EN 60751	Pt100	-200...850 °C	-328...1562 °F
Pt1000	EN 60751	Pt1000	-200...850 °C	-328...1562 °F
Fe-CuNi	EN 60584-1	J	-50...1200 °C	-58...2192 °F
Cu-CuNi	EN 60584-1	T	-50...400 °C	-58...752 °F
NiCr-NiAl	EN 60584-1	K	-50...1372 °C	-58...2501.6 °F
PtRh10-Pt	EN 60584-1	S	0...1767 °C	32...3212.6 °F
PtRh13-Pt	EN 60584-1	R	0...1767 °C	32...3212.6 °F
PtRh30-PtRh6	EN 60584-1	B	200...1767 °C ¹⁾	392...3212.6 °F 1)
NiCrSi-NiSi	EN 60584-1	N	-50...1300 °C	-58...2372 °F

¹⁾ Accuracy refers to measuring range 200...1767 °C (392...3212.6 °F)

^{*)} Sensor line resistance <10 Ω/conductor; connection should be made with cables of equal cross-section and length

Accuracy of actual value measuring

0.3%, for thermo-resistant inputs,

0.3%, for thermoelectric sensors (0.5% – for B, R, S);

Measurement time 0.33 s

Error detection in measurement circuit:

- thermocouple, Pt100 exceeding the measuring range

Output Type:

- relay potential free change over contact, load capacity 5 A/230 V a.c., maximum 200 thousand switching cycles for resistive load 5A 230 V a.c.

Nominal operating conditions:

- Supply voltage 230 V a.c. $\pm 10\%$
- power supply frequency 50/60 Hz
- Ambient temperature 0...23...50 °C
- Storing temperature -20...+70 °C
- relative humidity < 85 % (no condensation)
- warm up time 30 min
- working position any

Power consumption

< 4 VA

Weight

< 0.25 kg

Degree of protection provided by housing acc. to EN 60529

- from the front panel IP65
- from the terminals IP20

Additional errors in rated operating conditions caused by:

- compensation of temperature changes
 - thermocouple reference joints ≤ 2 °C
- line resistance change of the sensor
 - thermo-resistant ≤ 50 % of the accuracy value
- change of ambient temperature ≤ 100 % of accuracy /10 K

Safety requirements according to EN 61010-1¹⁾

- insulation between the circuits basic
- installation category III
- degree of pollution 2
- maximum operating voltage relative to earth
 - for power supply circuit, output 300 V
 - for input circuits 50 V
- altitude below 2000 m

Electromagnetic compatibility

- immunity to electromagnetic interference according to EN 61000-6-2
- emission of electromagnetic interference according to EN 61000-6-4

12. Limiter ordering code

The coding method is given in Table 11.

Versions and ordering method

Table 11

Temperature limiter <i>RL10</i> –		XX	X	X
Version	Standard	00		
	Custom-made ¹⁾	XX		
Language	Polish		P	
	English		E	
	other ²⁾		X	
Acceptance tests:	without additional requirements			0
	with quality inspection certificate			1
	acc. to customer's requirements ²⁾			X

- 1) the numbering will be determined by the manufacturer
- 2) after consultation with the manufacturer



LUMEL S.A.

ul. Sulechowska 1, 65-022 Zielona Góra, POLAND

tel.: +48 68 45 75 100, fax +48 68 45 75 508

www.lumel.com.pl

Export department:

tel.: (+48 68) 45 75 139, 45 75 233, 45 75 321, 45 75 386

fax.: (+48 68) 32 54 091

e-mail: export@lumel.com.pl