

POWER NETWORK METER
ND30BAC



USER'S MANUAL



Contents

1 APPLICATION.....	2
2 METER SET.....	2
3 BASIC REQUIREMENTS, OPERATIONAL SAFETY.....	3
4 INSTALLATION.....	3
5 METER DESCRIPTION.....	4
5.1 Current inputs	4
5.2 Voltage inputs.....	4
5.3 External connection diagrams.....	5
6 ND30BAC Programming.....	8
6.1 Front panel.....	8
6.2 Starting work.....	9
7 OPERATING MODES.....	9
7.1 Measurement mode.....	12
7.1.1. Measurement of voltage and current harmonics.....	12
7.2 Parameters mode.....	12
7.3 Alarms mode.....	15
7.4 Display mode.....	17
7.5 Ethernet / BACnet IP.....	22
7.6 Modbus mode.....	23
7.7 Settings mode	24
7.8 Information mode	24
8 SERIAL INTERFACES.....	25
8.1 Ethernet / BACnet IP Interface	25
8.2 Connecting Ethernet/ BACnet IP interfaces	26
8.3 RS485 INTERFACE – list of parameters.....	27
8.4 Examples of registers' readout and write.....	27
9 ND30BAC METER DATA STRUCTURE.....	30
9.1 Data structure for the Ethernet / BACnet IP interface.....	30
9.2 Registers structure for RS-485 / Modbus interface.....	35
10 SOFTWARE UPGRADE.....	51
10.1 Firmware update - main program of the meter.....	51
11 ERROR CODES.....	52
12 TECHNICAL DATA.....	52
13 ORDERING CODE.....	55

1 APPLICATION

The ND30BAC meter is a programmable digital instrument designed for the measurement of 1-phase 2-wire and 3-phase 3 and 4-wire power network parameters in balanced or unbalanced systems. The measured values are displayed on a 3,5" TFT full-color screen, resolution: 320x240 pixel. The meter enables control and optimization of the power electronic devices, systems and industrial installations.

The meter provides measurement of: RMS of voltage and current, active, reactive and apparent power, active, reactive and apparent energy, power factors, frequency, the harmonics of current and voltage /up to 51st/, THD of voltage and current, averaged active and apparent power P Demand, S Demand, averaged current I Demand /15, 30 or 60 minutes/. Voltages and currents are multiplied by given voltage and current ratios of the measuring transformers. Power and energy indications take into account all programmed ratio values. The value of each measured value can be transmitted to the master system via the RS-485 or Ethernet/ BACnet IP interface. Relay outputs signal the overflow of the chosen value.

There is a galvanic separation between following units of the meter:

- supply
- voltage inputs
- current inputs
- RS485 interface
- Ethernet interface
- alarm outputs

2 METER SET

Complete set of the meter includes:

- | | |
|------------------------------------|-------|
| 1. ND30BAC meter | 1 pc |
| 2. seal | 1 pc |
| 3. screw clamp to fix in the panel | 4 pcs |
| 4. plug with 16 screw terminals | 1 pc |
| 5. plug with 14 screw terminals | 1 pc |
| 6. user's manual | 1 pc |



Fig. 1a. Meter set (ND30BAC meter)

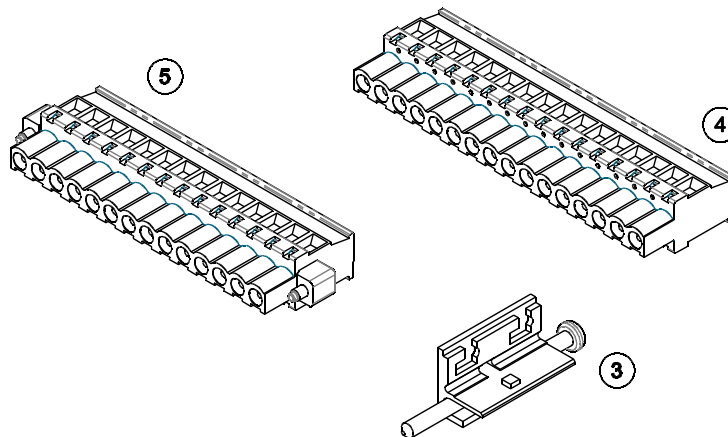

Fig. 1b. Meter set

3 BASIC REQUIREMENTS, OPERATIONAL SAFETY

In terms of operational safety the controller meets the requirements of the EN 61010-1 standard.

Remarks concerning safety:

- The meter should be installed and connected only by a qualified personnel. All relevant safety measures should be observed during installation.
- Always check the connections before turning the meter on.
- Prior to taking the meter housing off, always turn the supply off and disconnect the measuring circuits.
- Removal of the meter housing during the warranty period voids the warranty.
- This meter conforms to all requirements of the electromagnetic compatibility in the industrial environment.
- A switch or a circuit-breaker should be installed in the building or facility. It should be located near the device, easily accessible by the operator, and suitably marked.

4 INSTALLATION

The meter is intended to be fixed to the panel with mounting brackets as presented on Fig. 1. The meter housing is made of a self-extinguishing plastics.

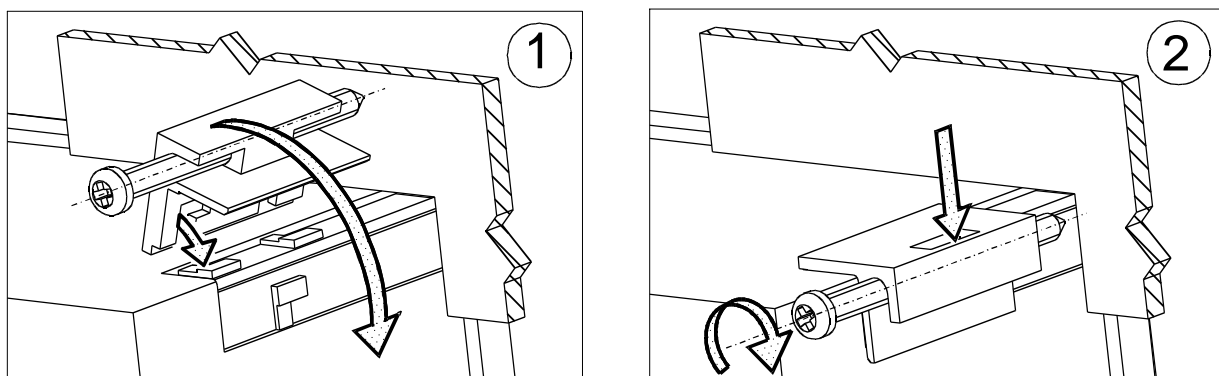

Fig. 2. Meter fitting

Housing overall dimensions 96 x 96 x 77 mm, dimensions of the assembly hole 92.5 x 92.5 mm. There are screw terminal strips on the outer side of the meter which enable the connection of external wires of diameter up to 2.5 mm².

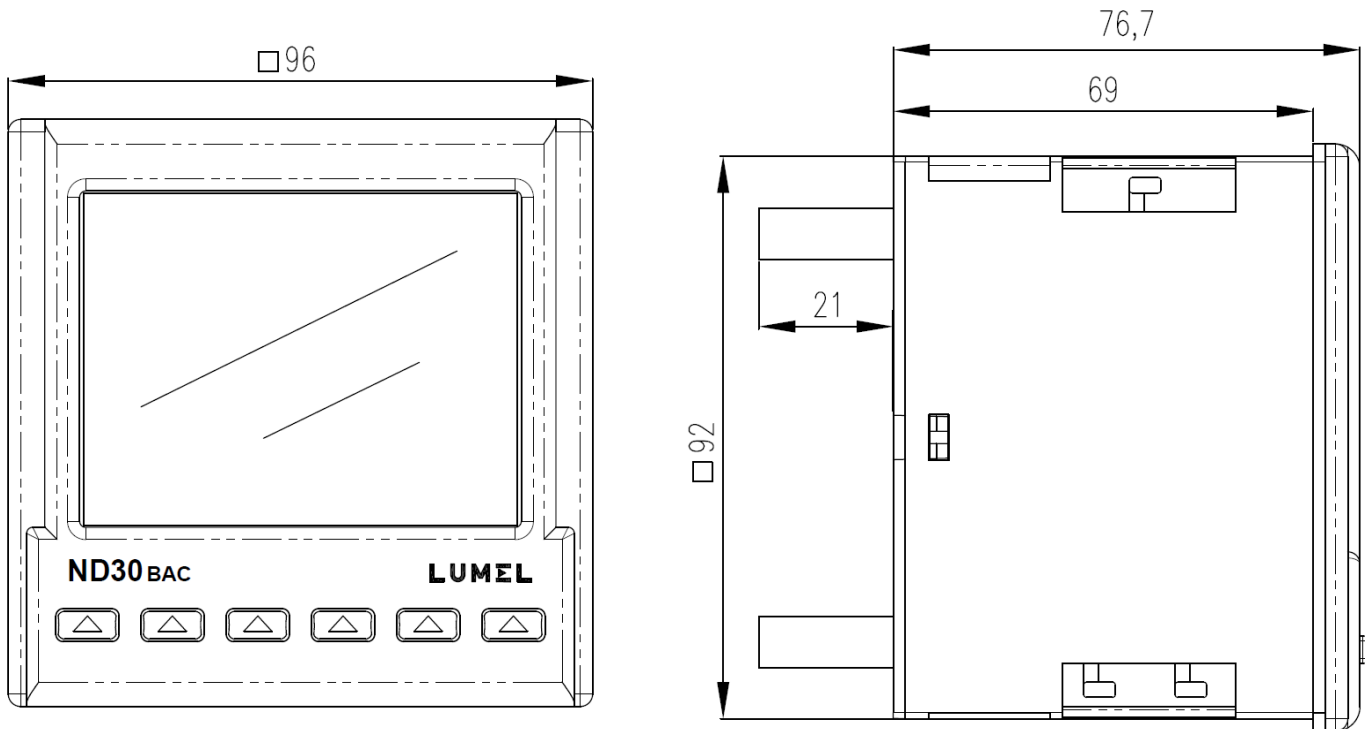

Fig. 3. Overall dimensions of the ND30BAC meter

5 METER DESCRIPTION

5.1 Current inputs

All current inputs are galvanically isolated (internal current transformers). The meter is adapted to work with external measuring current transformers / 1 A or 5 A /. Displayed current values and derivative values are automatically converted in relation to the introduced external current transformer ratio.

5.2 Voltage inputs

All voltage inputs are galvanically isolated (internal transformers). Values on voltage inputs are automatically converted according to the introduced ratio of the external voltage transformer. Voltage inputs are specified in the order as 3x57.7/100 V, 3x230/400 V or 3x110/190 V, 3x400/690 V.

5.3 External connection diagrams

External connections are shown in Fig. 4.

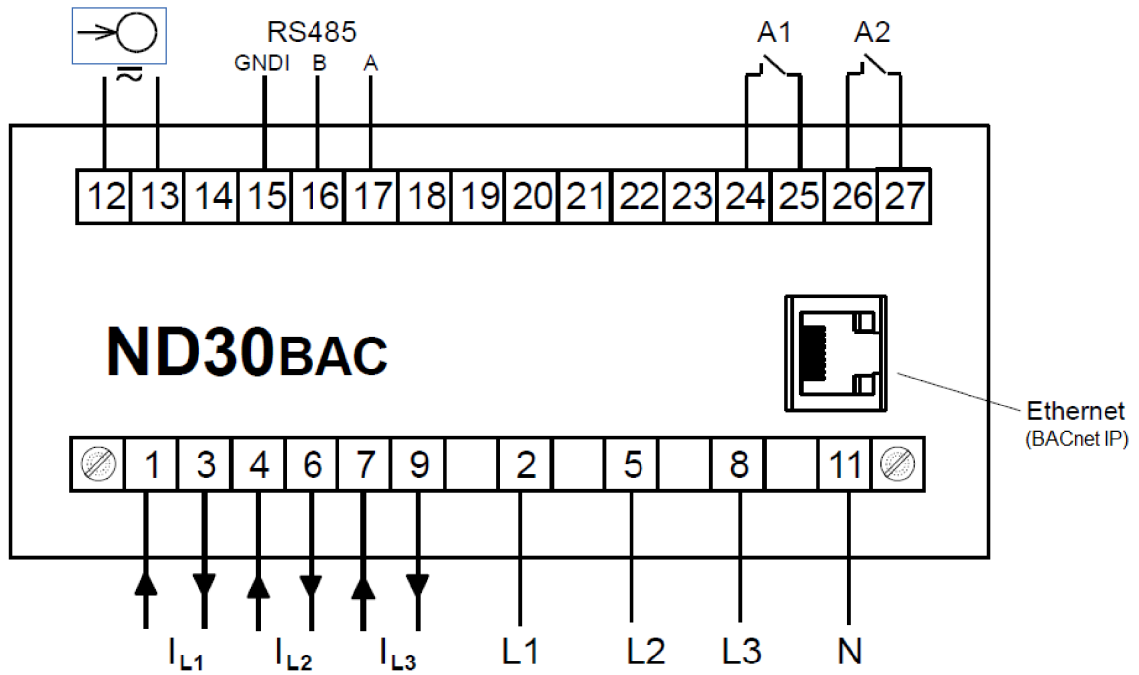

Fig. 4. Meter connections

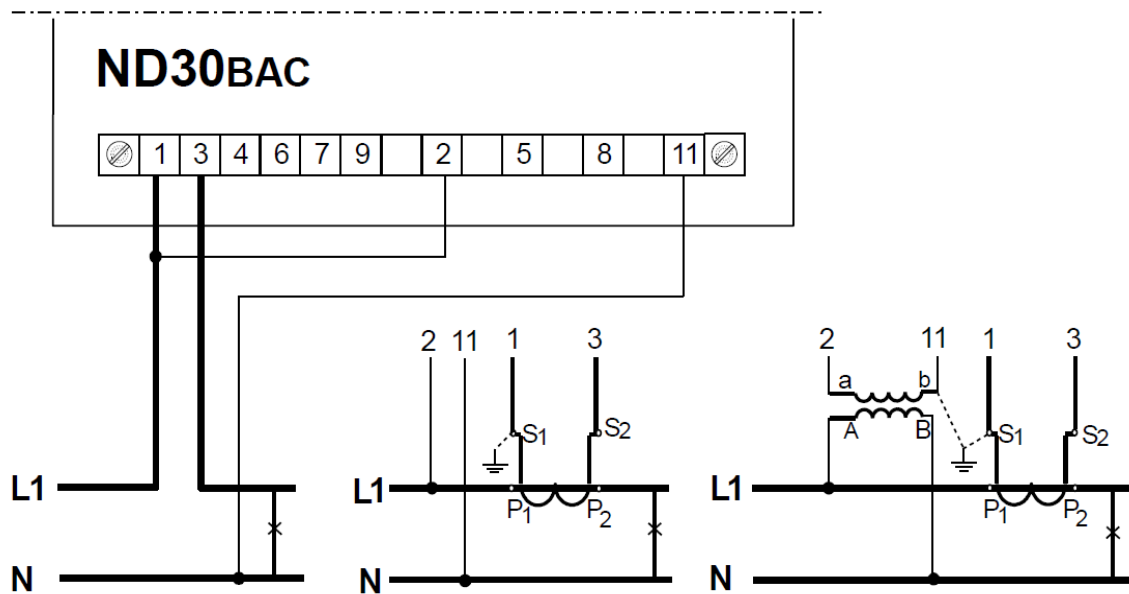
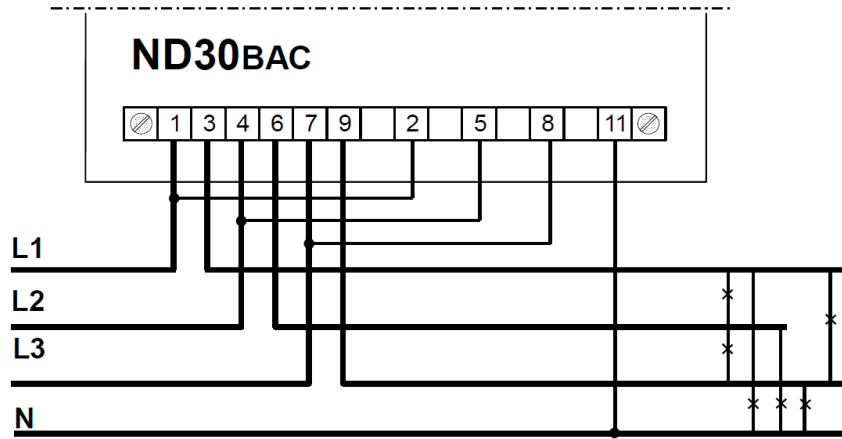
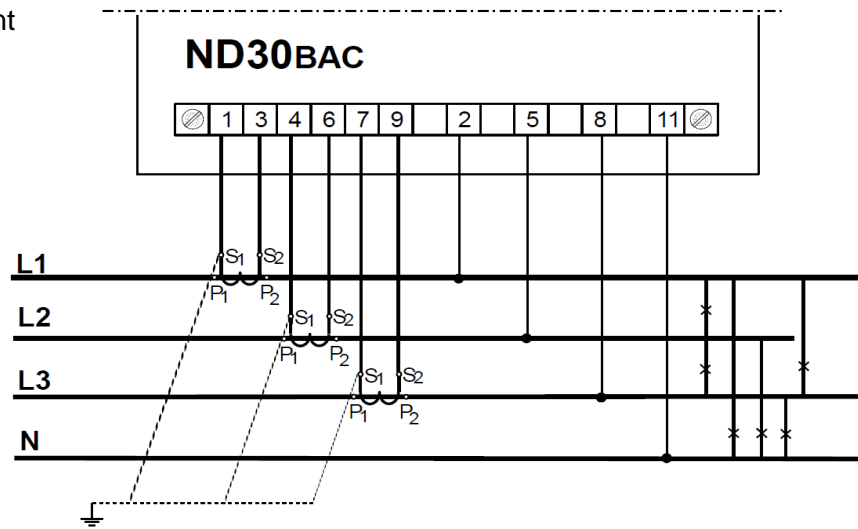

Fig. 5. Direct measurement, indirect and semi-indirect in a 1-phase network

Direct measurement
in 4-wire network



Semidirect measurement
in 4-wire network



Indirect measurement
in 4-wire network

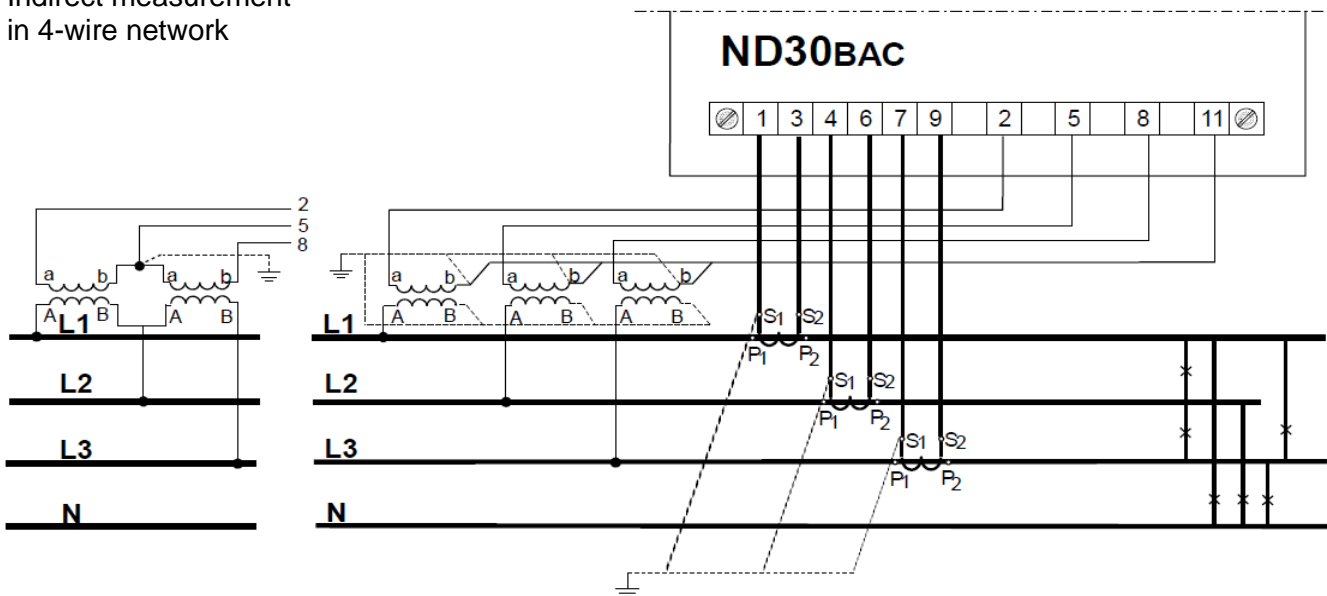
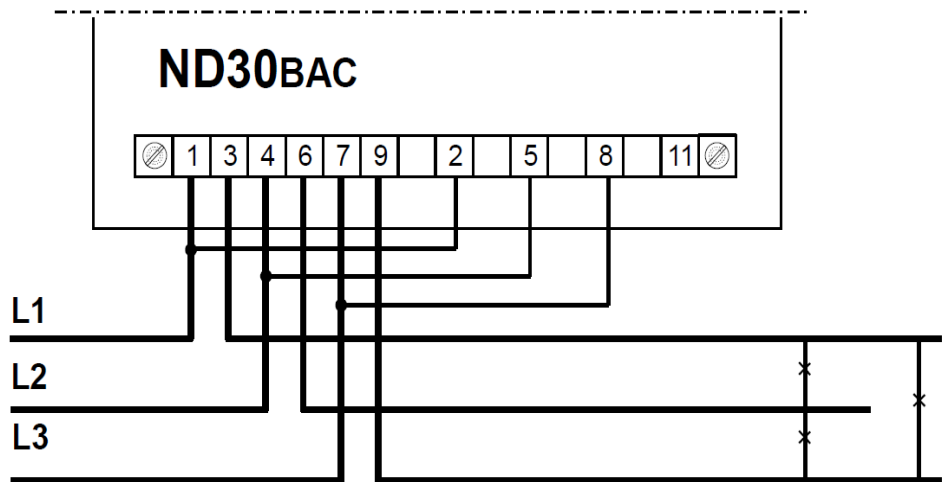
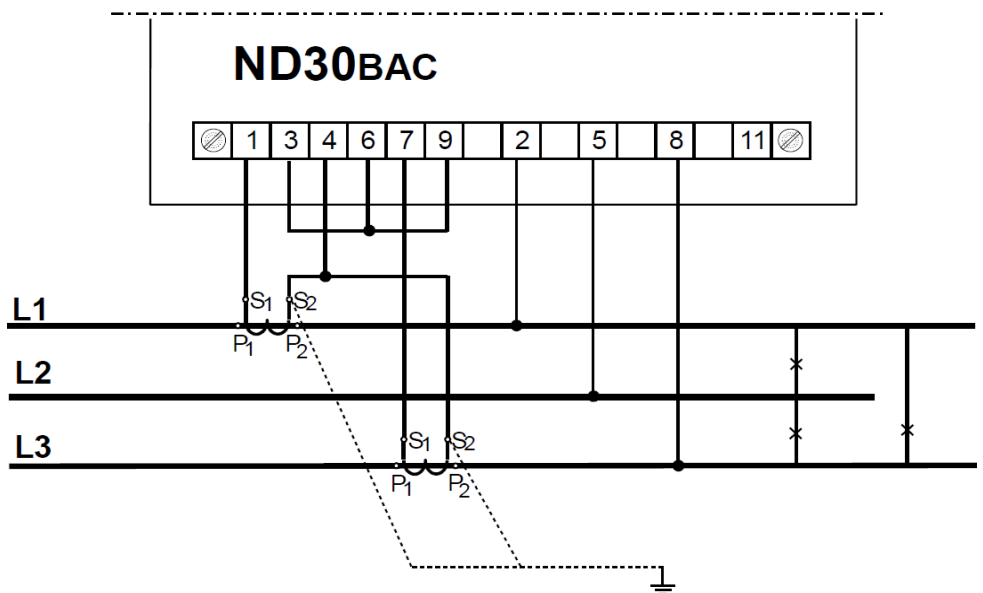

Fig. 6. Meter connections of input signals in a 3-phase 4-wire network

Direct measurement in a 3-wire network



Semi-indirect measurement using 2 current transformers in a 3-wire network



Indirect measurement using 2 current transformers and 2 or 3 voltage transformers in a 3-wire network

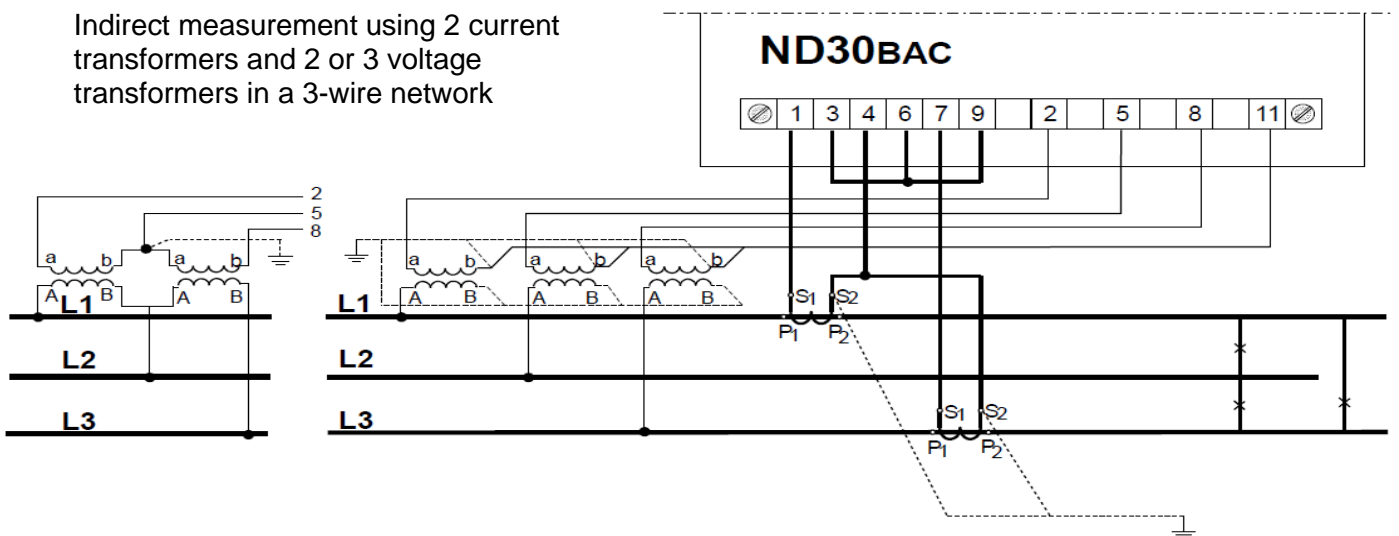

Fig. 7. Meter connections of input signals in a 3-phase 3-wire network



6 ND30BAC PROGRAMMING



6.1 Front panel



Fig. 8. Front panel

The ND30BAC meter has 6 buttons and a full-color graphic screen. Front panel description:

f1, ... , f8	8 field displays - the digits for readout and settings,	DMD	Averaged value indicator (Demand)
V, A, W, var, VA, Wh, varh, Hz,	units of the displayed values	k, M	kilo = 10 ³ ; Mega = 10 ⁶
U1, I1, P1,EnQ	displayed parameters markings	 	The markers indicating the inductive, capacity load character

The values of the measured parameters are shown on the active pages selected by subsequent pressing the buttons  (next page) or  (previous page).

The page consists any 8 values selected from the Table 1 and displayed simultaneously on the display. The page definition is described in the **Display** mode. Depending on the location, meter buttons can perform different functions. Functions are described in the bar on the bottom of the screen. If the button lacks description, it is inactive at the moment.

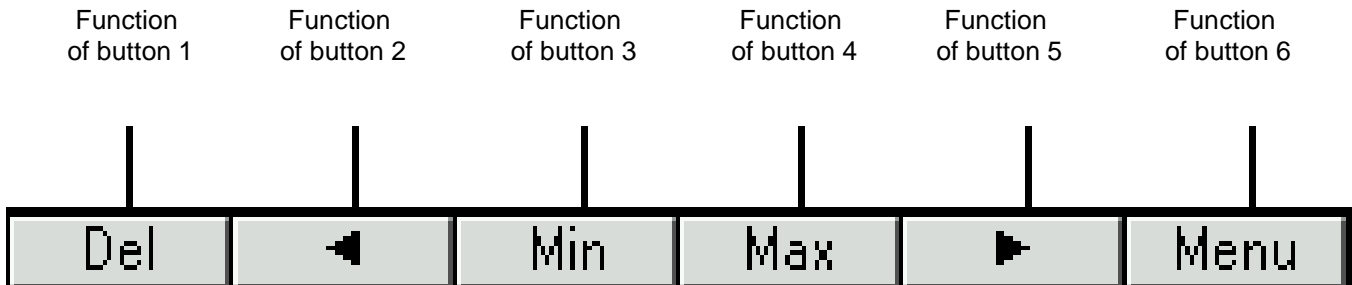

Fig. 9. Buttons marking – example

Information bar at the top of the screen displays the status of the alarm outputs, alarm conditions, a symbol of Ethernet connection, the indicators of receiving and transmitting data on the RS485 link, date and real-time clock. A symbol "phase sequence error" will be blinking in case of a negative phase sequence.



Fig. 10. Information bar

6.2 Starting work

After switching the supply on, the meter displays the ND30BAC meter name, version, current software version and MAC for the version with Ethernet and then moves to the measurement mode and last saved page. Displayed information:

ND30BAC v:0.80 – meter type, program version number

Bootloader v.01.06 – bootloader version number

U: 57.7/230.0 V – voltage versions

I: 1.0/5.0 A – current versions

MAC: AB:CD:EF:01:23:45 (for versions with Ethernet)



Fig. 11. Screen of meter measuring mode

7 OPERATING MODES

The ND30BAC meter has 10 operating modes:

Measure – normal work mode. In the **Measure** mode the values are displayed according to the pages that are preset at the factory or configured by the user.

Parameters – meter parameters configuration

Alarms – Alarm 1, Alarm 2 configuration

Display – displayed pages configuration

Archiving – archived values configuration

Ethernet – Ethernet interface configuration

Modbus – RS485 interface parameters configuration

Settings – settings: password, language, time, date

Information – preview of a program version, serial number, MAC address

To move from the **Measure** mode to any other mode, press the button **Menu** for approx. 3 seconds.

Buttons **▼** **▲** allow to select the appropriate mode, to accept press the button **Select**

To return to a measurement mode use the button **Exit**

Parameters	Connection wire 3 phase - 4 wire 3 phase - 3 wire 1 phase - 2 wire	Current input range <input type="radio"/> 1 A <input checked="" type="radio"/> 5 A	Voltage input range <input type="radio"/> 3x57.7/100V <input checked="" type="radio"/> 3x230/400V or <input type="radio"/> 3x110/190V <input checked="" type="radio"/> 3x400/690V	Voltage transformer primary 0000 <u>100</u>	Voltage transformer secondary 00 <u>100.0</u>	Current transformer primary 0000 <u>5</u>	Current transformer secondary 0000 <u>5</u>	Demand integ. time <input checked="" type="radio"/> 15 min <input type="radio"/> 30 min <input type="radio"/> 60 min	AVG synchronization <input checked="" type="radio"/> lack <input type="radio"/> with RTC
	Voltage connector 2 <input checked="" type="radio"/> U1 <input type="radio"/> U2 <input type="radio"/> U3	Voltage connector 5 <input type="radio"/> U1 <input checked="" type="radio"/> U2 <input type="radio"/> U3	Voltage connector 8 <input type="radio"/> U1 <input type="radio"/> U2 <input checked="" type="radio"/> U3	Current connector 1-3 <input checked="" type="radio"/> I1 <input type="radio"/> -I1 <input type="radio"/> I2 <input type="radio"/> -I2 <input type="radio"/> I3 <input type="radio"/> -I3	Current connector 4-6 <input type="radio"/> I1 <input type="radio"/> -I1 <input checked="" type="radio"/> I2 <input type="radio"/> -I2 <input type="radio"/> I3 <input type="radio"/> -I3	Current connector 7-9 <input type="radio"/> I1 <input type="radio"/> -I1 <input type="radio"/> I2 <input type="radio"/> -I2 <input checked="" type="radio"/> I3 <input type="radio"/> -I3	Delete energy counters <input checked="" type="radio"/> No <input type="radio"/> active <input type="radio"/> reactive <input type="radio"/> apparent <input type="radio"/> all	Delete demand values <input checked="" type="radio"/> No <input type="radio"/> Yes	Set parameters defaults <input checked="" type="radio"/> No <input type="radio"/> Yes
Alarms	Alarm 1	Logical conditions <input checked="" type="radio"/> C1 <input type="radio"/> C1 v C2 v C3 <input type="radio"/> C1 ^ C2 ^ C3 <input type="radio"/> C1 ^ C2 v C3 <input type="radio"/> (C1 v C2) ^ C3	Relay state if alarm on <input type="radio"/> off <input checked="" type="radio"/> on	Holdback alarm off <input checked="" type="radio"/> off <input type="radio"/> on	Display alarm event <input checked="" type="radio"/> off <input type="radio"/> on	Set defaults <input checked="" type="radio"/> No <input type="radio"/> Yes			
		Alarm 2	Value <input checked="" type="radio"/> U1 <input type="radio"/> I1 <input type="radio"/> P1 <input type="radio"/> Q1 : <input type="radio"/> hh:mm	Condition type <input checked="" type="radio"/> n_on <input type="radio"/> noFF <input type="radio"/> on <input type="radio"/> oFF <input type="radio"/> H_on : <input type="radio"/> 3_oF	Low limit condition [%] +0099 <u>0</u>	High limit condition [%] +0101 <u>0</u>	Delay to condition on [s] 000 <u>0</u>	Delay to condition off [s] 000 <u>0</u>	Holdback condition off->on [s] 000 <u>0</u>

Fig. 12a. Programming matrix

Displaying	Settings	Backlight level <input type="radio"/> Minimum <input type="radio"/> Medium <input checked="" type="radio"/> Maximum	Time to Backlight level min [s] 0000	Pages cfg <input checked="" type="radio"/> page 1 <input checked="" type="radio"/> page 2 <input checked="" type="radio"/> page 3 : <input checked="" type="radio"/> page 12	Pages color <input checked="" type="radio"/> green <input type="radio"/> red <input type="radio"/> yellow : <input type="radio"/> olive	Set page defaults <input checked="" type="radio"/> No <input type="radio"/> Yes
	Page 1 : Page 10	Display field 1 Display field 2 : : Display field 8	<input type="radio"/> Off <input checked="" type="radio"/> U1 <input type="radio"/> I1 <input type="radio"/> P1 <input type="radio"/> Q1 : <input type="radio"/> En S			

Fig. 12b. Programming matrix

Ethernet / BACnet IP	Addresses	DHCP <input checked="" type="radio"/> on <input type="radio"/> off	Mode <input checked="" type="radio"/> Auto <input type="radio"/> 10Mb/s <input type="radio"/> 100Mb/s	IP address 000.000.000.000	Subnet mask 000.000.000.000	Default gateway 000.000.000.000	MAC address aa:bb:cc:00:21:01
	Device ID	Instance number 99999	Device name ND30BACnet				



Fig. 12c. Programming matrix







Modbus	Address 001	Speed <input type="radio"/> 4800 b/s <input checked="" type="radio"/> 9600 b/s <input type="radio"/> 19,2 kb/s <input type="radio"/> 38,4 kb/s <input type="radio"/> 57,6 kb/s <input type="radio"/> 115,2 kb/s	Mode <input checked="" type="radio"/> RTU8N2 <input type="radio"/> RTU8N1 <input type="radio"/> RTU8O1 <input type="radio"/> RTU8N1	Factory settings reg. 42xx <input checked="" type="radio"/> No <input type="radio"/> Yes						
	Settings	Password ****	Language <input type="radio"/> English <input checked="" type="radio"/> Polish <input type="radio"/> Deutsch	Waiting time 13.47	Date 08/09/2017	Factory settings <input checked="" type="radio"/> No <input type="radio"/> Yes				
Information		Type ND30BAC	Ordering code 12200	Version of loader 1.06	Version of program 0.80	Serial number 17070006	MAC address aa:bb:cc:00:21:01	DHCP on	IP address 10.0.0.190	Subnet mask 255.0.0.0

Fig. 12d. Programming matrix

7.1 Measurement mode

In the **Measure** mode the values are displayed according to the pages that are preset at the factory or configured by the user in the **Display** mode.

Changing the page is done by pressing the buttons  or .

Preview of the maximum or minimum values respectively is done while the button  or  is pressed down. Reset of maximum or minimum values is done by pressing the button  while viewing their values, i.e. first the button  or  and then  must be pressed.

Simultaneously pressing the button  and  will copy internal memory to files archive.



When reactive power or reactive inductive or capacity energy is displayed, this indication is accompanied by a symbol of the load character: L for an inductive load or C for a capacity load.



When displaying the active power, the sign "+" is displayed for active energy import or "-" for active energy export.

Exceeding of the upper or lower indication range is signaled on the display by $\wedge\wedge\wedge\wedge$ or $\vee\vee\vee\vee$. For measurement of the averaged values (P DMD, S DMD, I DMD) single measurements are carried out with 0.25 second quantum. Averaging time to choose from: 15, 30 or 60 minutes. Until all samples of the averaged values are acquired, the values are calculated from already measured samples.

Current value in the neutral wire IN is calculated from phase current vectors.

7.1.1. Measurement of voltage and current harmonics

The choice of harmonics is done by selecting the pages dedicated to display the values of voltage harmonics U1, U2, U3 and currents I1, I2, I3 simultaneously for 3-phase (page 11). The number of a displayed harmonics can be changed in the range of 2..51 by the buttons  or .

Page 12 shows a bar chart of the harmonics for each phase: voltage at the top and currents at the bottom of the screen. Page 12 shows a bar chart of the harmonics. The choice of displayed harmonics is done by pressing a button . The button  is used to select the groups of harmonics: harm₂ - harm₂₆, harm₂₇ - harm₅₂ or harm₂ - harm₅₁.

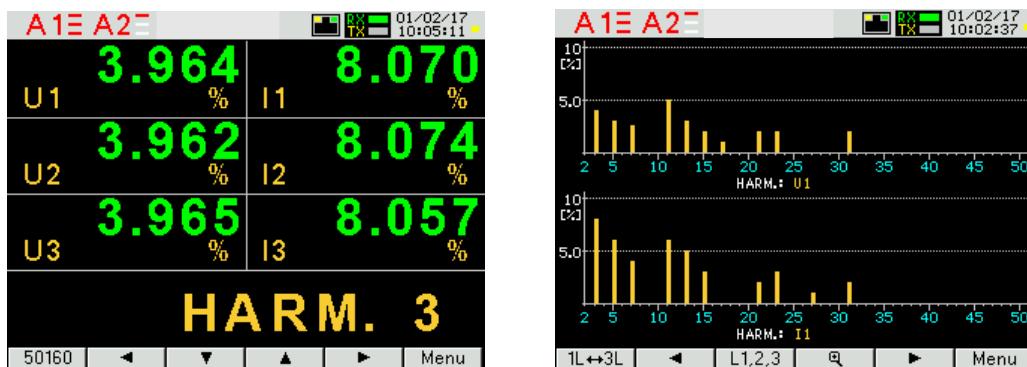





Fig. 13. Screens 11 and 12 - visualization of harmonics

7.2 Parameters mode

This mode is used to determine the parameters of the meter. To enter Parameters mode press the button

 for approx. 3 seconds and next using the button  or  select Parameters mode, to accept press the button . The parameters configuration mode is protected by a password, if it was entered and it is different from zero. The password prompt is skipped for the password 0000. If the password is incorrect, the message "Wrong password. Read only menu" is displayed. Then it is possible to view the parameters, but the changes are not possible.

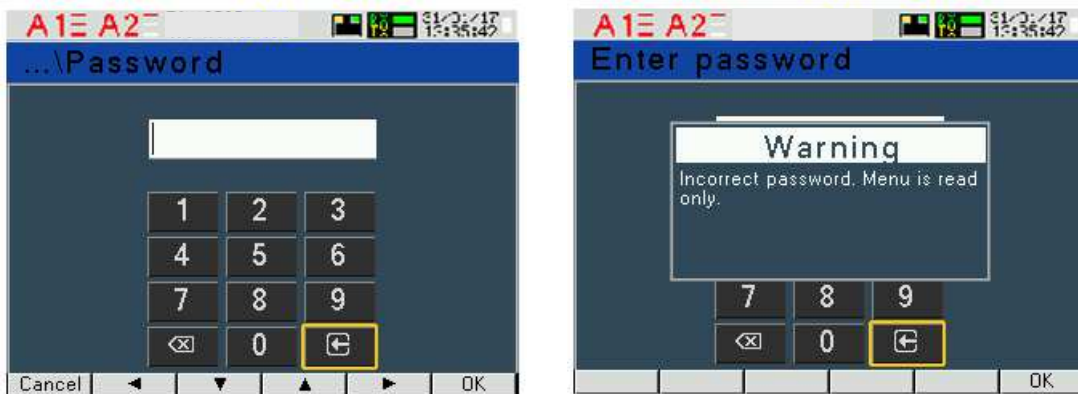
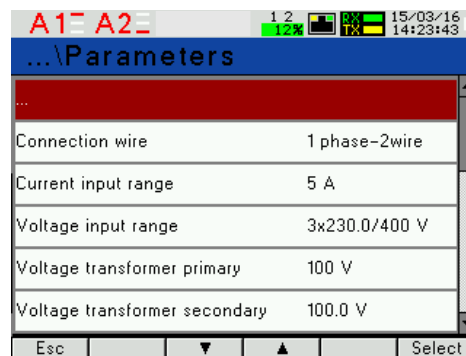
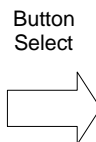
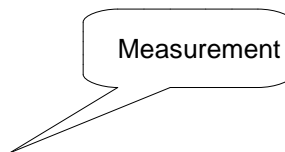
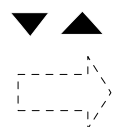

Fig. 14. Screens while entering a password

If the password is correct or it has not been entered, you can set the values according to Table 2. Buttons are used to choose the parameter, to accept press the button **Select**. Then use the buttons to choose the features of a parameter or set the requested parameter values, i.e. you can choose the digit in the decimal position by the button or the digit value by the button or . The active position is signaled by the cursor. Set value or parameter can be accepted by the button **OK** or canceled by pressing **Cancel**. Exit from the Parameters procedure follows pressing simultaneously the button **Esc** or after waiting for approx. 120 seconds. Exit from the Selecting parameters menu follows pressing the button **Exit** or after waiting for approx. 120 seconds.



The buttons



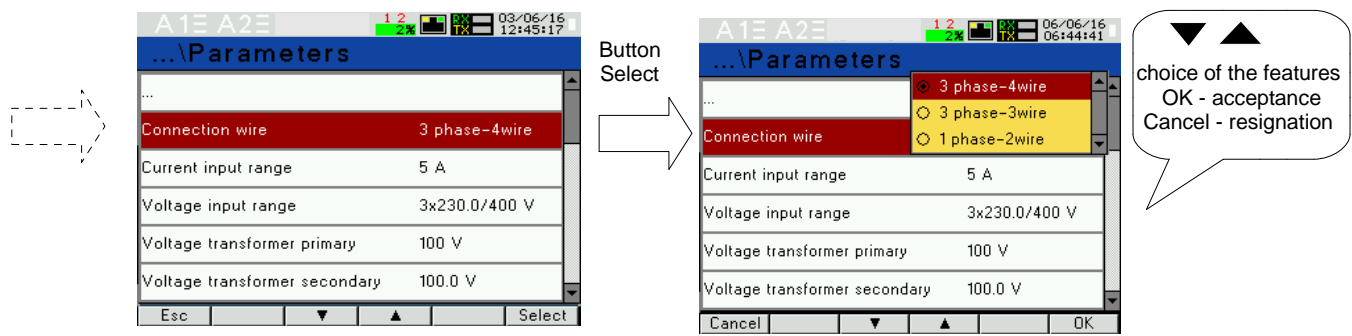

Fig. 15. Screens of Parameters mode

Table 1

Item	Parameter name	Feature / value	Description	Default settings
1	Connection wire	3 phase -4 wire 3 phase -3 wire 1 phase -2 wire	Type of power network 3-phase 4-wire 3-phase 3-wire 1-phase 2-wire	3 phase -4 wire
2	Current input range	1A, 5A	Input range: 1A or 5A	5A
3	Voltage input range	3x57.7/100 V; 3x230/400 V; or 3x110/190 V; 3x400/690 V;	Choice of the ranges depending on the ordering code	3x230/400 V or 3x400/690 V
4	Voltage transformer primary	1 .. 1245183 V		100
5	Voltage transformer secondary	0.1 .. 01000.0		100.0
6	Current transformer primary	1...20000		5
7	Current transformer secondary	1...1000		5
8	Damend integ. time	15 min, 30 min, 60 min	Averaging time active power P DMD, apparent power S DMD, current I DMD	15 min
9	AVG synchronization	none, with RTC	Averaging synchronized with the real-time clock	none
10	Voltage connector 2	U1, U2, U3		U1
11	Voltage connector 5	U1, U2, U3		U2
12	Voltage connector 8	U1, U2, U3		U3
13	Current connector 1-3	I1,-I1,I2,-I2,I3,-I3		I1
14	Current connector 4-6	I1,-I1,I2,-I2,I3,-I3		I2
15	Current connector 7-9	I1,-I1,I2,-I2,I3,-I3		I3
16	Delete energy counters	No, Active, Reactive, Apparent, All		No
17	Delete demand values	No, Yes		No
18	Default parameters	No, Yes		No

During changing the parameter, it is checked if the value is in the range. If the set value falls outside the allowable range, the value is set to the maximum value (when entered value is too high) or minimum value (when it is too low).

Free eCon software can also be used for configuration of the ND30BAC meters, it is available on www.lumel.com.pl.

7.3 Alarms mode

In the options, select the **Alarms** mode and confirm selection by pressing the button **Select**.

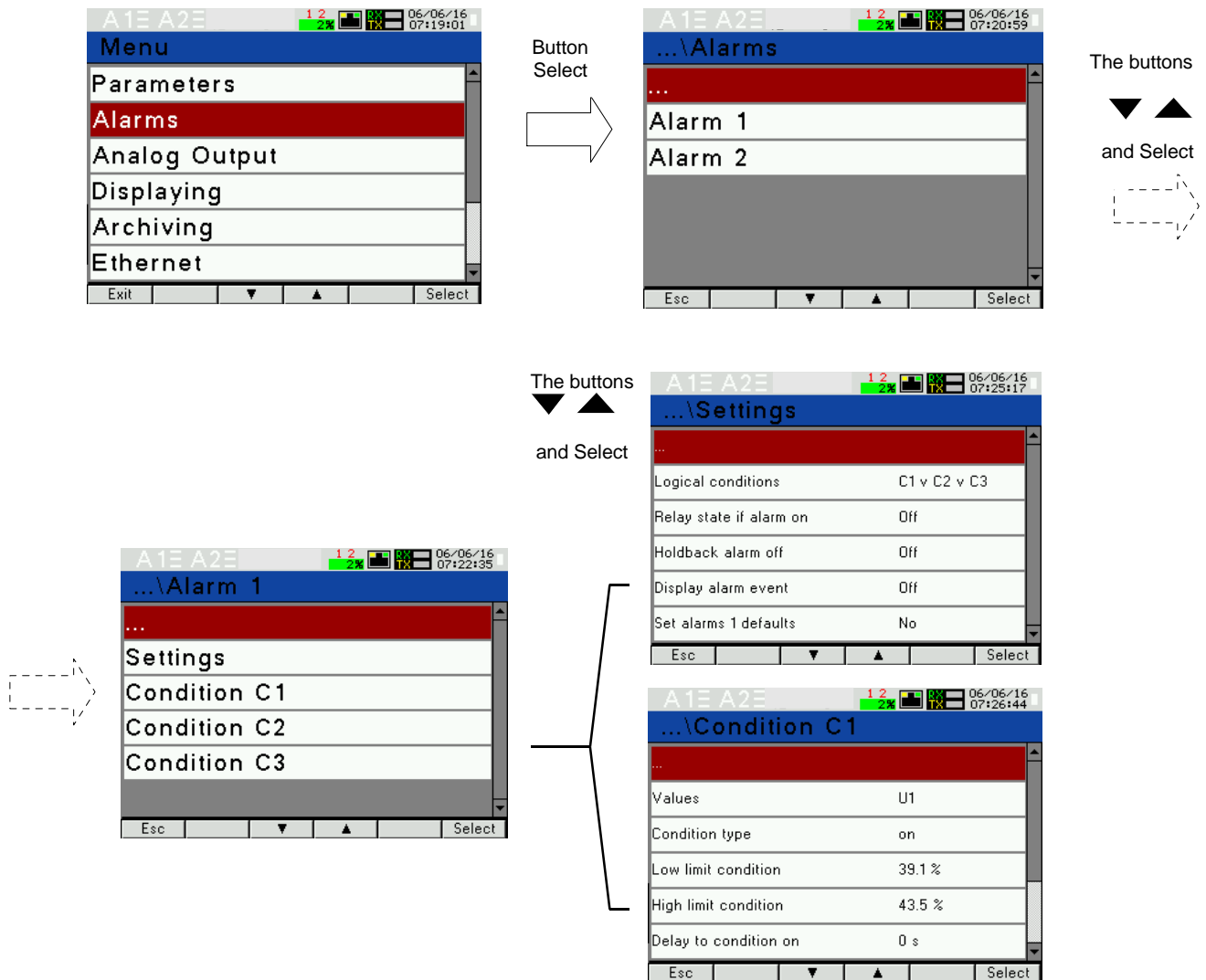

Fig. 16. Screens of Alarms mode

Table 2

Item		Parameter name	range	Notes/description	Default settings
1	Settings	Logical conditions	C1 C1 v C2 v C3 C1 ^ C2 ^ C3 (C1 ^ C2) v C3 (C1 v C2) ^ C3		C1
2		Relay state if alarm on	Off/On	State of the relay at the alarm switched on Off/On	On
3		Holdback alarm off	Off/On		Off
4		Display alarm event	Off/On	When alarm indication function is enabled and the alarm state ends, alarm symbol is not turned off but begins to flash. Signalization symbol flashes until it is turned off by pressing the button Del and Alarm (> 1 sec.). This function refers only to the alarm signalization, so the relay contacts will operate without	Off

				a latch according to the selected alarm type.	
		Values	U1, I1,...,T2, hh:mm	Value on the alarm output parameters acc. to Table 8	U1
6	Condition 1 Condition 2 Condition 3	Condition type	n_on, noFF, on,oFF, H_on, HoFF, 3non, 3noF, 3_on, 3_oF	Acc. to Fig.17.	n-on
7		Low limit condition	-144.0...144.0	in % of the rated input value	90.0
8		High limit condition	-144.0...144.0	in % of the rated input value	110.0
9		Delay to condition on	0 ... 3600	in seconds	0
10		Delay to condition off	0 ... 3600	in seconds	0
11		Holdback condition off->on	0 ... 3600	in seconds	0
12		Display condition event	Off/On	When a latch function is enabled and the condition state ends, condition symbol is not turned off but begins to flash. Signalization symbol flashes until it is turned off by pressing the button Cancel and Alarm (> 3 sec.).	Off

Entering "Condition upper value" lower then "Condition lower value" disables a condition.

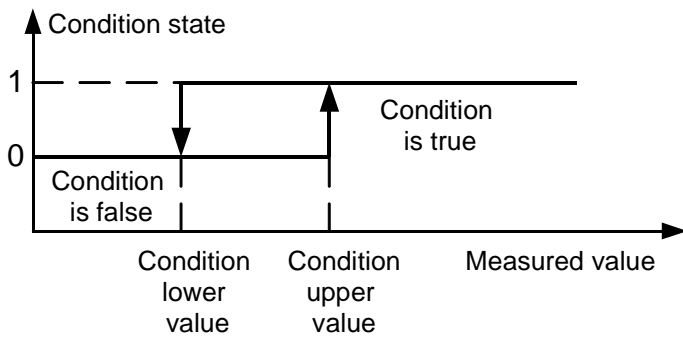

a) n_on

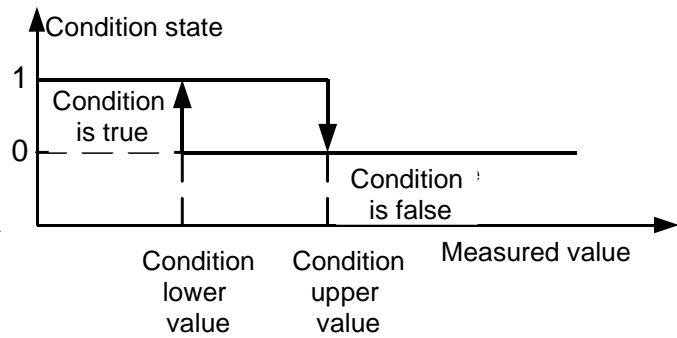

b) noFF

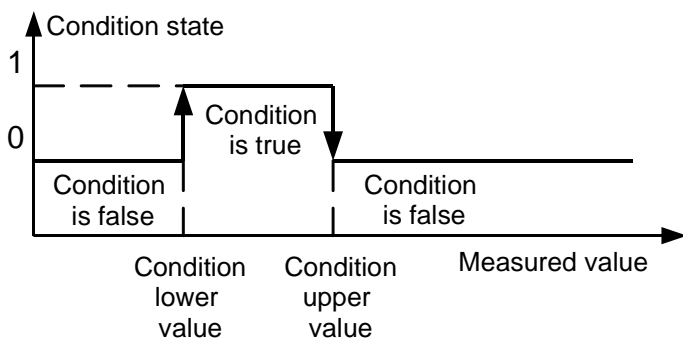

c) on

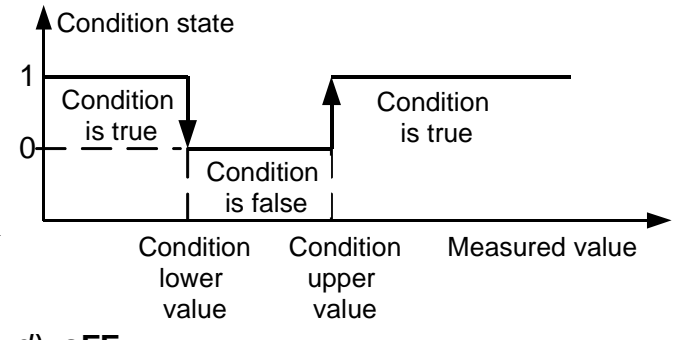

d) oFF

Fig. 17. Condition types: a) n_on b) noFF c) on d) oFF

Remaining types of the condition:

- **H_on** – always true;
- **HoFF** – always not true,
- **3non** – when the measuring value on any phase exceeds the "Condition upper value" - condition is true. The condition will be disabled if the measuring value on all phases will be lower than "Condition lower value".
- **3noF** – when the measuring value on any phase will be lower than the "Condition lower value" - condition is true. The condition will be disabled if the measuring value on all phases will be higher

than "Condition upper value".

- **3_on** – when the measuring value on any phase will be between the "Condition lower value" and "Condition upper value" - condition is true. The condition will be disabled if the measuring value on all phases will be below "Condition lower value" or above "Condition upper value".
- **3_oF** – when the measuring value on any phase will be below the "Condition lower value" or above "Condition upper value" - condition is true. The condition will be disabled if the measuring value on all phases will be between the "Condition lower value" and "Condition upper value".
- The alarm value in the series 3 alarms must be in the range: 01-09, 10-18 and 19-27 (acc. to Table 8). They work with identical thresholds "Condition lower value" and "Condition upper value" for each phase. The blanking of the alarm signalization latch follows pressing the buttons **Del** and **Alarm** (> 3 sec.).

7.4 Display mode

In this mode, you can configure the pages displayed in a normal work mode of the meter Measurement

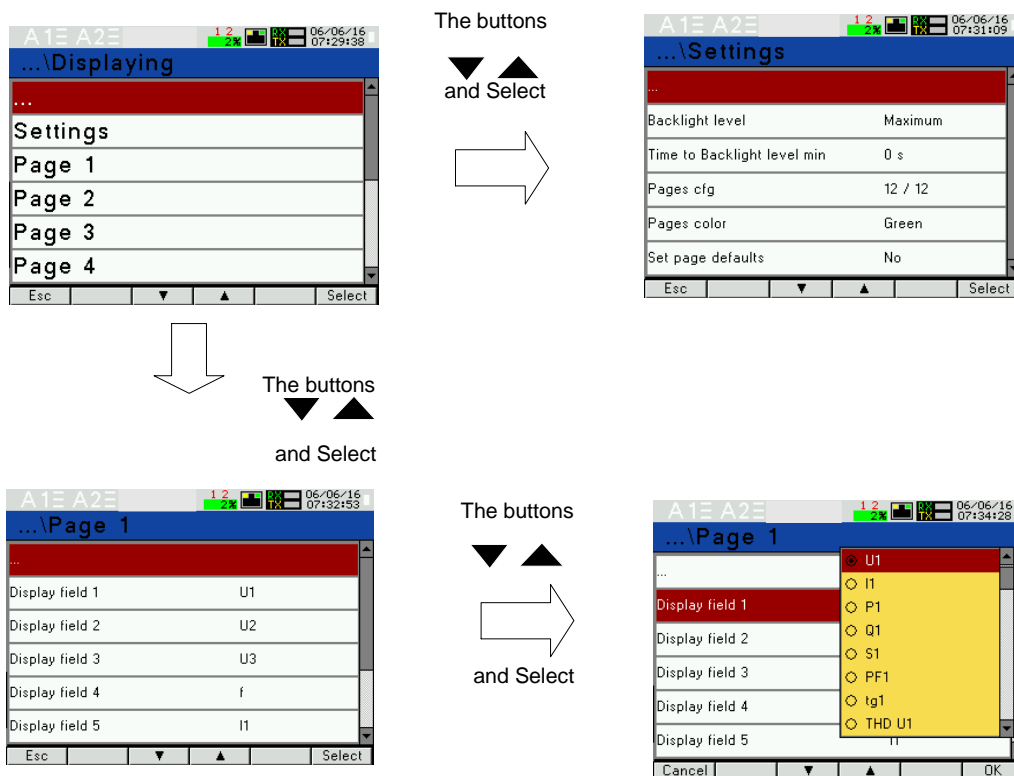

Fig. 19. Screens of Display mode

Table 4

Item		Parameter name	Range	Notes/description	Default settings
1	Settings	Backlight level	Minimum, Medium, Maximum		Maximum
		Time to Backlight level min	0..9999	in seconds	0
		Pages cfg	Page 1 Page 2 : Page 11 Page 12	Selection of pages visualized in Measurement mode	Page 1 Page 2 : Page 11 Page 12
2		Pages color	Green Red Yellow : Olive	Color of displayed values in Measurement mode	Green
3		Display field 1	No Yes		No
4	Page 1 : : : Page 10	Display field 1 : : : Display field 8	Off U1 I1 P1 Q1 : En S	Selection of displayed values on a selected page and selected field acc. to Table 5.	Table 6a or 6b or 6c - depending on the connection system

Selection of displayed values:

Table 5

Item	value name	marking	unit	Signaling	3Ph / 4W	3Ph / 3W	1Ph / 2W
00	no value - blanked display field	Off			√	√	√
01	L1 phase voltage	U1	(M, k)V		√	x	√
02	L1 phase wire current	I1	(k)A		√	√	√
03	L1 phase active power	P1	(G, M, k)W		√	x	√
04	L1 phase reactive power	Q1	(G, M, k)var	$\xi / \text{⏏}$	√	x	√
05	L1 phase apparent power	S1	(G, M, k)VA		√	x	√
06	L1 phase active power factor (PF1=P1/S1)	PF1			√	x	√
07	tgφ factor of L1 phase (tg1=Q1/P1)	tg1			√	x	√
08	L1 phase voltage THD*	THD U1	%		√	√	√
09	L1 phase current THD	THD I1	%		√	√	√
10	L2 phase voltage	U2	(M,k)V		√	x	x
11	L2 phase wire current	I2	(k)A		√	√	x
12	L2 phase active power	P2	(G, M, k)W		√	x	x
13	L2 phase reactive power	Q2	(G, M, k)var	$\xi / \text{⏏}$	√	x	x
14	L2 phase apparent power	S2	(G, M, k)VA		√	x	x
15	L2 phase active power factor (PF2=P2/S2)	PF2	PF		√	x	x
16	tgφ factor of L2 phase (tg2=Q2/P2)	tg2			√	x	x

17	L2 phase voltage THD*	THD U2	%		√	√	x
18	L2 phase current THD	THD I2	%		√	√	x
19	L3 phase voltage	U3	(M,k)V		√	x	x
20	L3 phase wire current	I3	(k)A		√	√	x
21	L3 phase active power	P3	(G, M, k)W		√	x	x
22	L3 phase reactive power	Q3	(G, M, k)var	$\xi / \text{⏏}$	√	x	x
23	L3 phase apparent power	S3	(G, M, k)VA		√	x	x
24	L3 phase active power factor (PF3=P3/S3)	PF3			√	x	x
25	tg* factor of L3 phase (tg3=Q3/P3)	tg3			√	x	x
26	L3 phase voltage THD*	THD U3	V%		√	√	x
27	L3 phase current THD	THD I3	A%		√	√	x
28	mean phase voltage	U avg	(M, k)V		√	x	x
29	mean 3-phase current	I avg	(k)A		√	√	x
30	3-phase active power	ΣP	(G, M, k)W	+/-	√	√	√
31	3-phase reactive power	ΣQ	(G, M, k)var	$\xi / \text{⏏}$	√	√	√
32	3-phase apparent power	ΣS	(G, M, k)VA		√	√	√
33	active power factor 3-phase (PF=P/S)	PF avg			√	√	x
34	tgφ factor average for 3 phases (tg=Q/P)	tg avg			√	√	x
35	THD U mean 3-phase*	THD U	%		√	√	x
36	THD I mean 3-phase	THD I	%		√	√	x
37	frequency	f	Hz		√	√	√
38	phase-to-phase voltage L1-L2	U12	(M,k)V		√	√	x
39	phase-to-phase voltage L2-L3	U23	(M,k)V		√	√	x
40	phase-to-phase voltage L3-L1	U31	(M,k)V		√	√	x
41	mean phase-to-phase voltage	U123	(M,k)V		√	√	x
42	active power averaged (P Demand)	P DMD	(G, M, k)W		√	√	√
43	apparent power averaged (S Demand)	S DMD	(G, M, k)VA		√	√	√
44	current averaged (I Demand)	I DMD	(k)A		√	√	√
45	neutral wire current	I N	(k)A		√	x	x
46	RESERVED	-	-		-	-	-
47	RESERVED	-	-		-	-	-
48	Active 3-phase import energy	En P+	kWh		√	√	√
49	Active 3-phase export energy	En P-	kWh		√	√	√
50	Reactive 3-phase inductive energy	En Q ξ	kvarh		√	√	√
51	Reactive 3-phase capacity energy	En Q ⏏	kvarh		√	√	√
52	3-phase apparent energy	En S	kVAh		√	√	√

* In the 3-phase 3-wire system (3Ph / 3W) respectively THD U12, THD U23, THD U31, THD U123

Default settings of the displayed pages in 3-phase 4-wire system

Table 6a

P1		P2		P3		P4		P5	
U1 V	I1 A	U12 V	ΣP W	P1 W	PF1	P1 W	Q1 var	THD U1 %	THD I1 %
U2 V	I2 A	U23 V	ΣQ var	P2 W	PF2	P2 W	Q2 var	THD U2 %	THD I2 %
U3 V	I3 A	U31 V	ΣS VA	P3 W	PF3	P3 W	Q3 var	THD U3 %	THD I3 %
f Hz	I avg A	U123 V	PF avg	ΣP W	PF avg	ΣP W	ΣQ var	THD U %	THD I %
P6		P7		P8		P9		P10	
U1 V	S1 VA	U2 V	S2 VA	U3 V	S3 VA	ΣP W	P DMD W	ΣP W	+En P kWh
I1 A	PF1	I2 A	PF2	I3 A	PF3	ΣQ var	S DMD W	ΣQ var	-En P kWh
P1 W	tg1	P2 W	tg2	P3 W	tg3	I avg A	I DMD A	ΣS VA	En Q ξ kvarh
Q1 var	f Hz	Q2 var	f Hz	Q3 var	f Hz	I(N) A	f Hz	En S kVAh	En Q ⏏ kvarh
P11		P12							
U1 %	I1 %	HARM.:U1U2U3 % bargraf							
U2 %	I2 %								
U3 %	I3 %	HARM.:I1I2I3 % bargraf							
HARM.2..51									

Pages 11 and 12 cannot be configured.

Default settings of the displayed pages in 3-phase 3-wire system

Table 6b

P1		P2		P3		P4		P5	
U12 V	I1 A	U12 V	ΣP W	ΣP W	P DMD W	THD U12 %	THD I1 %	ΣP W	En P+ kWh
U23 V	I2 A	U23 V	ΣQ var	ΣQ var	S DMD W	THD U23 %	THD I2 %	ΣQ var	En P- kWh
U31 V	I3 A	U31 V	ΣS VA	I avg A	I DMD A	THD U31 %	THD I3 %	ΣS VA	En Q ξ kvarh
f Hz	I avg A	U123 V	PF avg	tg avg	PF avg	THD U123 %	THD I %	En S kVAh	En Q ⏏ kvarh

Default settings of the displayed pages in 1-phase system Table 6c

P1		P2		P3	
U1 V	S1 VA	P1 W	P DMD W	P1 W	En P+ kWh
I1 A	PF1	S1 VA	S DMD W	Q1 var	En P- kWh
P1 W	tg1	I1 A	I DMD A	S1 VA	En Q _ξ kvarh
Q1 var	f Hz	PF1	f Hz	En S kVAh	En Q _⊕ kvarh

The choice of parameters on alarm outputs is shown in table 7.

Table 7

Value in register	Dispalyed parameter	Parameter	Percentage value corresponding to 100% of the nominal range.
01	U1	voltage of phase L1	Un [V] *
02	I1	current in the L1 phase conductor	In [A] *
03	P1	Active power of phase L1	Un x In x cos(0°) [W] *
04	Q1	Reactive power of phase L1	Un x In x sin(90°) [Var] *
05	S1	Apparent power of phase L1	Un x In [VA] *
06	PF1	Power factor PF of phas L1	1
07	tg1	tgφ factor of phase L1	1
08	THD U1	THD of voltage in phase L1**	100.00 [%]
09	THD I1	THD of current in phase L1	100.00 [%]
10	U2	voltage of phase L2	Un [V] *
11	I2	current in the L2 phase conductor	In [A] *
12	P2	Active power of phase L2	Un x In x cos(0°) [W] *
13	Q2	Reactive power of phase L2	Un x In x sin(90°) [Var] *
14	S2	Apparent power of phase L2	Un x In [VA] *
15	PF2	Power factor PF of phase L2	1
16	tg2	tgφ factor of phase L2	1
17	THD U2	THD of voltage in phase L2**	100.00 [%]
18	THD I2	THD of current in phase L2	100.00 [%]
19	U3	voltage of phase L3	Un [V] *
20	I3	current in the L3 phase conductor	In [A] *
21	P3	Active power of phase L3	Un x In x cos(0°) [W] *
22	Q3	Reactive power of phase L3	Un x In x sin(90°) [Var] *
23	S3	Apparent power of phase L3	Un x In [VA] *
24	PF3	Power factor PF of phase L3	1
25	tg3	tgφ factor of phase L3	1
26	THD U3	THD of voltage in phase L3**	100.00 [%]
27	THD I3	THD of current in phase L3	100.00 [%]
28	U avg	Mean phase voltage	0.00 [%]
29	I avg	Mean 3-phase current	In [A] *
30	ΣP	3-phase active power (P1+P2+P3)	3 x Un x In x cos(0°) [W] *
31	ΣQ	3-phase reactive power (Q1+Q2+Q3)	3 x Un x In x sin(90°) [Var] *
32	ΣS	3-phase apparent power (S1+S2+S3)	3x Un x In [VA] *

33	PF avg	Factor of 3-phase active power PF	1
34	tg avg	3-phase tgφ factor	1
35	THD U	3-phase THD of voltage**	100,00 [%]
36	THD I	3-phase THD of current	100,00 [%]
37	f	frequency	100 [Hz]
38	U12	Phase-to-phase voltage L1-L2	$\sqrt{3}$ Un [V] *
39	U23	Phase-to-phase voltage L2-L3	$\sqrt{3}$ Un [V] *
40	U31	Phase-to-phase voltage L3-L1	$\sqrt{3}$ Un [V] *
41	U123	Mean phase-to-phase voltage	$\sqrt{3}$ Un [V] *
42	P DMD	Mean active power (P Demand)*	$3 \times Un \times In \times \cos(0^\circ)$ [W] *
43	S DMD	Mean apparent power (S Demand) *	$3 \times Un \times In$ [VA] *
44	I DMD	Mean current (I Demand) *	In [A] *
45	I(N)	Current in neutral conductor	In [A] *
48	En P+	Imported 3-phase active energy	100000 [kWh]
49	En P-	Exported 3-phase active energy	100000 [kWh]
50	En Q _L	Inductive 3-phase active energy	100000 [kvarh]
51	En Q _C	Capacitive 3-phase apparent energy	100000 [kvarh]
52	En S	3-phase apparent energy	100000 [kVAh]
53	Phase order	Phase order	L1,L2,L3 - 0,00 [%] L1,L3,L2 - 100,00 [%]
54	hh:mm	time, hhx100+mm	2400 - 100 [%]

*Un,In -rated values of nominal voltages and currents

**In a three-phase 3-wire system (3Ph / 3W) THD U12, THD U23, THD U31, THD U123 respectively

7.5 Ethernet / BACnet IP

In the options, select the **Addresses** or **Device ID** mode and confirm selection by pressing the button

Select

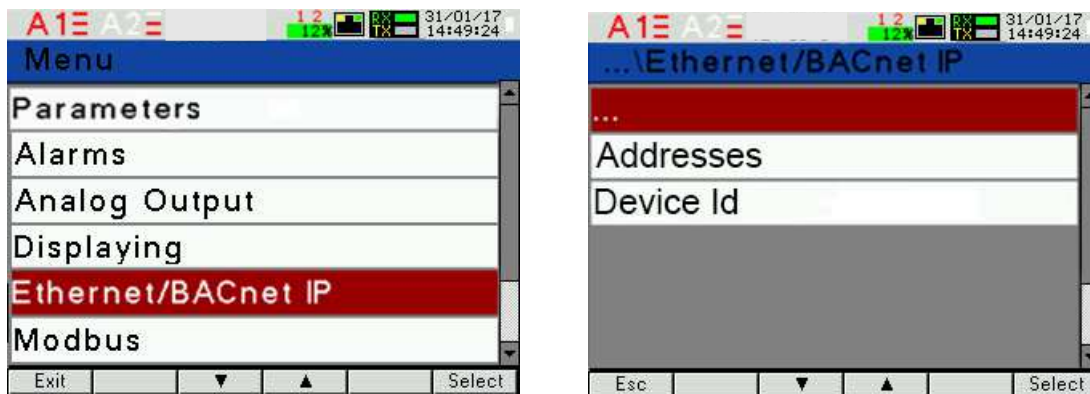

Fig. 20. Ethernet/ BACnet IP screen view.

Table 8

No.		Parameter name	Range	Remarks / Description (example)	Default settings
1	Addresses	DHCP	On/Off	On	On
2		mode	Auto / 10Mb/s / 100Mb/s	Auto	Auto
3		IP address	0.0.0.0...255.255.255.255	10.0.1.190	-
4		Subnet mask	0.0.0.0...255.255.255.255	255.0.0.0	-
5		Gateway address	0.0.0.0...255.255.255.255	10.10.10.203	-
6		MAC address	00:00:00:00:00:00 / FF:FF:FF:FF:FF:FF	AA:BB:CC:00:21:01	-
7	Device Id	Instance number	0-0x3FFFFFF	123456	99999
8		Device name	100 characters	ND30BAC BACnet IP device	ND30BAC

7.6 Modbus mode

In the options, select the **Modbus** mode and confirm your choice by pressing the button **Select**.

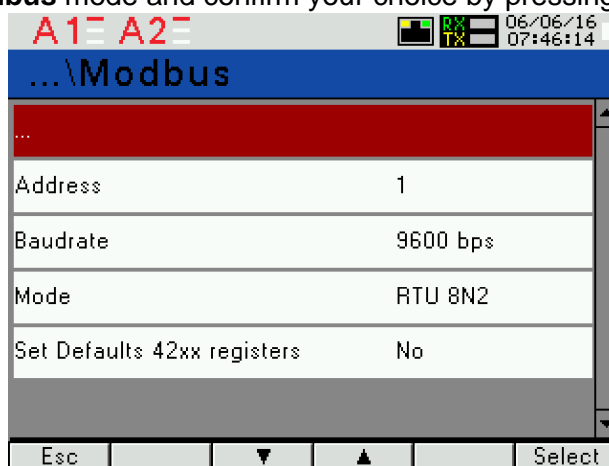

Fig.21. Screens of Modbus mode

Table 9

Item	Parameter name	Feature / value	Description	Manufacturer's value
1	Address	1...247	Modbus Network Address	1
2	Baud rate	4800 b/s, 9600 b/s, 19.2 kb/s, 38.4 kb/s, 57.7 kb/s, 115.2 kb/s	Baud rate	9600 b/s
3	Mode	RTU 8N2, RTU 8N1, RTU 8O1, RTU 8N1	Transmission mode	RTU 8N2
4	Set Defaults 42xx registers	No, Yes	Programmable group of registers for readout	No

7.7 Settings mode

In the options, select the **Settings** mode and confirm your choice by pressing the button **Select**.

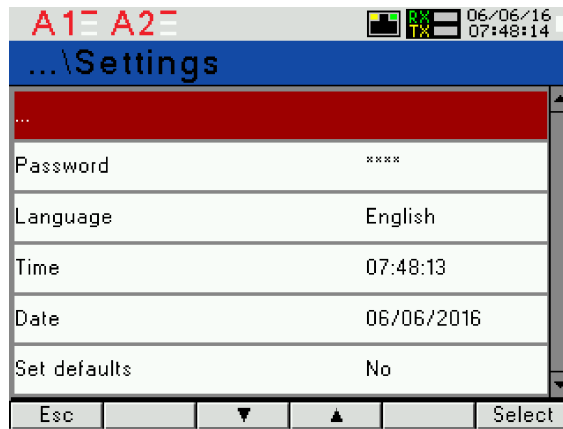

Fig.22. Screens of Settings mode

Table 10

Item	Parameter name	Feature / value	Description	Default value
1	Password	0 .. 9999	0 - disabled	0
2	Language	English, Polski, Deutsch		English
3	Time	hh:mm	hour:minute	00:00:00
4	Date	dd/mm/yyyy	Day/month/year	1.01.2015
5	Set defaults	No, Yes		No

7.8 Information mode

In the options, select the **Information** mode and confirm your choice by pressing the button **Select**.

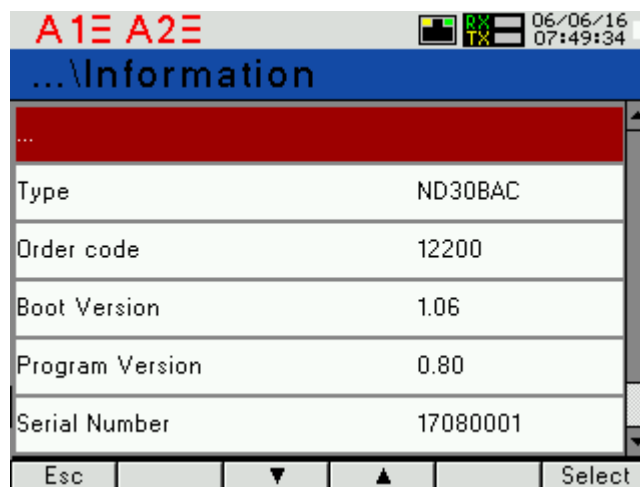

Fig.23. Screens of Information mode

Table 11

Item	Parameter name	Feature / value	Description	Manufacturer's value
1	Type		Meter type	ND30BAC
2	Order code		First 5 digits of the ordering code	e.g. 12200
3	Boot version		Bootloader version	e.g. 1.04
4	Program version		Main program version of the meter	e.g. 0.60
5	Serial number	ddmmxxxx	Current serial number of the meter day month current number	e.g. 15070006
	MAC address	xx:xx:xx:xx:xx:xx	48-bit hardware address of Ethernet interface in hexadecimal format	e.g. 64:0E:0D:0C:0B:0A

8 SERIAL INTERFACES

8.1 Ethernet / BACnet IP Interface

ND30BAC meters are equipped with a Fast Ethernet interface (100 Mb/s) enabling connection of the meter (using the RJ45 socket) to the Ethernet network. The BACnet IP communication standard described in the PN-EN ISO 16484-5 has been used.

In an Ethernet BACnet IP network, each device is identified by the IP address and port number, as well as by device name and instance number. The port number is fixed and is 47808. Parameters which can be modified in the meter from the level of the Menu are the meter's IP address, the Device object name, the Device object instance number. Below in table 12 there are the most important information about the properties of the implemented BACnet IP protocol. Functional blocks used (appendix K) can be found in table 13.

Table 12

Protocol version	1.0
Protocol revision number	12
Device profile (Annex L)	BACnet Application Specific Controller (B-ASC)
Standard objects used by the meter	Device Object, Analog Input Object
Data Link Layer	BACnet IP (appendix J)
Characters set supported	ANSI X3.4 (UTF-8)
Segmented messages	NOT SUPPORTED
Dynamically created objects	NOT SUPPORTED

Table 13

Data Sharing	Device Management
ReadProperty-B (DS-RP-B)	TimeSynchronization-B (DM-TS-B)
ReadPropertyMultiple-B (DS-RPM-B)	Dynamic Device Binding-B (DM-DDB-B)
WriteProperty-B (DS-WP-B)	
WritePropertyMultiple-B (DS-WPM-B)	
Change Of Value-B (DS-COV-B)*	

* The maximum subscription time is 1 year and the maximum number of subscriptions is 64.

The optional properties used by the Device to Location, Description object, while the optional properties used by the Analog Input to Description object. More information about Analog Input objects and measured quantities they represent can be found in Chapter 9. In case of the Device object, the *ReadPropertyMultiple* function cannot be used due to the lack of segmented messages mechanism. The PICS file for the device can be downloaded from www.lumel.com.pl.

8.2 Connecting Ethernet/ BACnet IP interfaces

Connect the device to a TCP/IP network using the RJ45 socket located at the back / terminal side / of the meter (working acc. To EN ISO 16484-5.) to get access to the Ethernet services.

The meter's RJ45 socket LEDs description:

- **yellow LED** - illuminates when the meter is properly connected to the Ethernet 100 Base-T, does not illuminate when the meter is not connected to a network or is connected to a 10-Base-T.
- **green LED** - Tx/Rx, illuminates (irregularly illuminates) when the meter sends and receives data, illuminates continuously when no data is transmitted

To connect the meter to the network, use wire twisted pair of STP type (shielded) CAT 5 - for high-speed local area networks, frequency bandwidth up to 100 MHz according to the European standard EN 50173 with RJ-45 plug with core color (according to Table 14) in the following standard :

- EIA/TIA 568A for both connectors at the so-called simple connection of ND30PNET to the network hub or switch,
- EIA/TIA 568A for the first connector and EIA/TIA 568B for the second connector at the so-called patch cord connection (crossover) used, among others, when connecting ND30PNET to the computer.

Table 14

Conductor no.	Signal	Conductor color acc. to standard	
		EIA/TIA 568A	EIA/TIA 568B
1	TX+	white-green	white-orange
2	TX-	green	orange
3	RX+	white-orange	white-green
4	EPWR+	blue	blue
5	EPWR+	white-blue	white-blue
6	RX-	orange	green
7	EPWR-	white-brown	white-brown
8	EPWR-	brown	brown

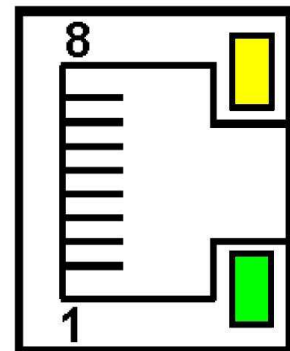

Fig. 24. View and pin numbering of the RJ45 socket

8.3 RS485 INTERFACE – list of parameters

The implemented protocol is compliant with the PI-MBUS-300 Rev G specification of Modicon. List of ND30BAC meter serial interface parameters:

- identifier 0xE5
- meter address 1..247,
- baud rate 4.8, 9.6, 19.2, 38.4, 57.6, 115.2 kbit/s
- operating mode Modbus RTU
- transmission mode 8N2, 8E1, 8O1, 8N1
- max. response time 600 ms
- max. no. of registers read in a single query
 - 61 – for 4-byte registers
 - 122 – for 2-byte registers
- implemented functions
 - 03, 04, 06, 16, 17
 - 03, 04 register readout
 - 06 single register writing
 - 16 writing of n-registers,
 - 17 device identification

Default settings: address 1, baud rate 9.6 kbit/s, mode RTU 8N2

8.4 Examples of registers' readout and write

Readout of n-registers (code 03h)

Example 1. Readout of two 16-bit integer registers, starting with the register address 0FA0h (4000) - register values 10, 100.

Request:

Device address	Function	Register address		Number of registers		CRC checksum
		B1	B0	B1	B0	
01	03	0F	A0	00	02	C7 3D

Response:

Device address	Function	Number of bytes	Value from the register 0FA0 (4000)		Value from the register 0FA1 (4001)		CRC checksum
			B1	B0	B1	B0	
01	03	04	00	0A	00	64	E4 6F

Example 2. Readout of two 32-bit float registers as a combination of two 16-bit registers, starting with the register address 1B58h (7000) - register values 10, 100.

Request:

Device address	Function	Register address		Number of registers		CRC checksum
		B1	B0	B1	B0	
01	03	1B	58	00	04	C3 3E

Response:

Device address	Function	Number of bytes	Value from the register 1B58 (7000)		Value from the register 1B59 (7001)		Value from the register 1B5A (7002)		Value from the register 1B5B (7003)		CRC checksum
			B3	B2	B1	B0	B3	B2	B1	B0	
01	03	08	41	20	00	00	42	C8	00	00	E4 6F

Example 3. Readout of two 32-bit float registers as a combination of two 16-bit registers, starting with the register address 1770h (6000) - register values 10, 100.

Request:

Device address	Function	Register address		Number of registers		CRC checksum
		B1	B0	B1	B0	
01	03	17	70	00	04	4066

Response:

Device address	Function	Number of bytes	Value from the register 1770h (6000)		Value from the register 1770h (6000)		Value from the register 1772h (6002)		Value from the register 1772h (6002)		CRC checksum
			B1	B0	B3	B2	B1	B0	B3	B2	
01	03	08	00	00	41	20	00	00	42	C8	E4 6F

Example 4. Readout of two 32-bit float registers, starting with the register address 1D4Ch (7500) - register values 10, 100.

Request:

Device address	Function	Register address		Number of registers		CRC checksum
		B1	B0	B1	B0	
01	03	1D	4C	00	02	03 B0

Response:

Device address	Function	Number of bytes	Value from the register 1D4C (7500)				Value from the register 1D4D (7501)				CRC checksum
			B3	B2	B1	B0	B3	B2	B1	B0	
01	03	08	41	20	00	00	42	C8	00	00	E4 6F

Single register writing (code 06h)

Example 5. Writing the value 543 (0x021F) to the register 4000 (0x0FA0)

Request:

Device address	Function	Register address		Register value		CRC checksum
		B1	B0	B1	B0	
01	06	0F	A0	02	1F	CA 54

Response:

Device address	Function	Register address		Register value		CRC checksum
		B1	B0	B1	B0	
01	06	0F	A0	02	1F	CA 54

Writing to n-registers (code 10h)

Example 6. Writing two registers starting with the register address 0FA3h (4003)

Writing the values 20, 2000.

Request:

Device address	Function	Address reg.Hi	Address reg.Lo	No. of registers Hi	No. of registers Lo	Number of bytes	Value for the register 0FA3 (4003)		Value for the register 0FA4 (4004)		CRC checksum
							B1	B0	B1	B0	
01	10	0F	A3	00	02	04	00	14	07	D0	BB 9A

Response:

Device address	Function	Register address		Number of registers		CRC checksum
		B1	B0	B1	B0	
01	10	0F	A3	00	02	B2 FE

Device identification report (code 11h)

Example 7. Device identification

Request:

Device address	Function	Checksum
01	11	C0 2C

Response:

Address	Function	Number of bytes	Identifier	Device status	Information field of the device software version (e.g. "ND30BAC-1.00 b-1.06" - ND30BAC device with software version 1.00 and bootloader version 1.06)	Checksum (CRC)
01	11	19	CF	FF	4E 34 33 20 2D 31 2E 30 30 20 20 20 20 20 20 20 20 20 62 2D 31 2E 30 36 20	E0 24

9 ND30BAC METER DATA STRUCTURE

In the ND30BAC meter, the data can be read using the BACnet IP protocol by reading the properties of individual objects configured in the device. The data can also be read using the RS485 interface and the ModBus protocol by reference to individual registers.

9.1 Data structure for the Ethernet / BACnet IP interface

The meter has two types of objects. This is a DEVICE type object and an ANALOG INPUT type object. The first of them occurs once. From the object one can read basic information about the meter, such as the name of the device, the instance number. The ANALOG INPUT objects are used to read measurement data. The measured value is contained in a variable called Present Value. Table 15 contains a list of the most important properties of ANALOG INPUT objects.

Table 15

Object instance number	Object name	Description	Units
1	U1	Voltage of L1 phase	V
2	I1	Current of L1 phase	A
3	P1	Active power of L1 phase	W
4	Q1	Reactive power of L1 phase	var
5	S1	Apparent power of L1 phase	VA
6	PF1	Factor of active power of L1 phase ($PF1=P1/S1$)	-
7	tg1	tgj factor of L1 phase ($tg1 =Q1/P1$)	-
8	THD U1(U12)	THD U1*	%
9	THD I1	THD I1	%
10	U2	Voltage of L2 phase	V
11	I2	Current of L2 phase	A
12	P2	Active power of L2 phase	W
13	Q2	Reactive power of L2 phase	var
14	S2	Apparent power of L2 phase	VA
15	PF2	Factor of active power of L2 phase ($PF2=P2/S2$)	-
16	tg2	tgj factor of L2 phase ($tg2 =Q2/P2$)	-
17	THD U2(U23)	THD U2*	%
18	THD I2	THD I2	%
19	U3	Voltage of L3 phase	V
20	I3	Current of L3 phase	A
21	P3	Active power of L3 phase	W
22	Q3	Reactive power of L3 phase	var
23	S3	Apparent power of L3 phase	VA
24	PF3	Factor of active power of L3 phase	-

		(PF3=P3/S3)	
25	tg3	tgj factor of L3 phase ($tg3 = Q3/P3$)	-
26	THD U3(U31)	THD U3*	%
27	THD I3	THD I3	%
28	Uavg	Average 3-phase voltage	V
29	Iavg	Average 3-phase current	A
30	P	3-phase active power ($P1+P2+P3$)	W
31	Q	3-phase reactive power ($Q1+Q2+Q3$)	var
32	S	3-phase apparent power ($S1+S2+S3$)	VA
33	PF	3-phase active power factor ($PF=P/S$)	-
34	tg	tgj factor 3-phase average ($tg=Q/P$)	-
35	THD U	THD U* 3-phase average	%
36	THD I	THD I 3-phase average	%
37	f	Frequency	Hz
38	U12	Phase-to-phase voltage L_{1-2}	V
39	U23	Phase-to-phase voltage L_{2-3}	V
40	U31	Phase-to-phase voltage L_{3-1}	V
41	U123	Average phase-to-phase voltage L1-2	V
42	P DMD	averaged active power (P Demand)	W
43	S DMD	averaged apparent power (S Demand)	VA
44	I_DMD	averaged current (I Demand)	A
45	I_N	Current in neutral wire (calculated from vectors)	A
46	CntEnP+	3-phase active imported energy (number of register 7546 overflows, reset after 9999.9 MWh is reached)	100 MWh
47	EnP+	3 –phase active imported energy (counter up to 99999.99 kWh)	kWh
48	CntEnP-	3-phase active exported energy (number of register 7548 overflows, reset after 9999.9 MWh is reached)	100 MWh
49	EnP-	3 –phase active exported energy (counter up to 99999.99 kWh)	kWh
50	CntEnQl	3-phase reactive inductive energy (number of register 7550 overflows, reset after 9999.9 MVarh is reached)	100 Mvarh
51	EnQl	Reactive inductive energy 3 –phase (counter up to 99999.99 kVarh)	kvarh
52	CntEnQc	3-phase reactive capacitive energy (number of register 7552 overflows, reset after 9999.9 MVarh is reached)	100 Mvarh
53	EnQc	Reactive capacitive energy 3 –phase (counter up to 99999.99 kVarh)	kvarh

54	CntEnS	Apparent energy (number of register 7554 overflows, reset after 9999.9 MVAh is reached)	100 MVAh
55	EnS	Apparent energy (counter up to 99999,99 kVAh)	kVAh
56	Status1	Status register 1	-
57	Status2	Status register 2	-
58	Status3	Status register 3	-
59	Status4	Status register 4	-
60	Status5	Status register 5	-
61	Status6	Status register 6	-
62	RESERVED	RESERVED	-
63	RESERVED	RESERVED	-
64	RESERVED	RESERVED	-
65	U1_min	Voltage L1 min	V
66	U1_max	Voltage L1 max	V
67	U2_min	Voltage L2 min	V
68	U2_max	Voltage L2 max	V
69	U3_min	Voltage L3 min	V
70	U3_max	Voltage L3 max	V
71	I1_min	Current L1 min	A
72	I1_max	Current L1 max	A
73	I2_min	Current L2 min	A
74	I2_max	Current L2 max	A
75	I3_min	Current L3 min	A
76	I3_max	Current L3 max	A
77	P1_min	Active power L1 min	W
78	P1_max	Active power L1 max	W
79	P2_min	Active power L2 min	W
80	P2_max	Active power L2 max	W
81	P3_min	Active power L3 min	W
82	P3_max	Active power L3 max	W
83	Q1_min	Reactive power L1 min	var
84	Q1_max	Reactive power L1 max	var
85	Q2_min	Reactive power L2 min	var
86	Q2_max	Reactive power L2 max	var
87	Q3_min	Reactive power L3 min	var
88	Q3_max	Reactive power L3 max	var
89	S1_min	Apparent power L1 min	VA
90	S1_max	Apparent power L1 max	VA
91	S2_min	Apparent power L2 min	VA
92	S2_max	Apparent power L2 max	VA
93	S3_min	Apparent power L3 min	VA

94	S3_max	Apparent power L3 max	VA
95	PF1_min	Power factor (PF) L1 min	-
96	PF1_max	Power factor (PF) L1 max	-
97	PF2_min	Power factor (PF) L2 min	-
98	PF2_max	Power factor (PF) L2 max	-
99	PF3_min	Power factor (PF) L3 min	-
100	PF3_max	Power factor (PF) L3 max	-
101	tg1_min	Ratio of reactive to active power L1 min	-
102	tg1_max	Ratio of reactive to active power L1 max	-
103	tg2_min	Ratio of reactive to active power L2 min	-
104	tg2_max	Ratio of reactive to active power L2 max	-
105	tg3_min	Ratio of reactive to active power L3 min	-
106	tg3_max	Ratio of reactive to active power L3 max	-
107	U12_min	Phase-to-phase voltage L ₁₋₂ min	V
108	U12_max	Phase-to-phase voltage L ₁₋₂ max	V
109	U23_min	Phase-to-phase voltage L ₂₋₃ min	V
110	U23_max	Phase-to-phase voltage L ₂₋₃ max	V
111	U31_min	Phase-to-phase voltage L ₃₋₁ min	V
112	U31_max	Phase-to-phase voltage L ₃₋₁ max	V
113	Uavg_min	Average 3-phase voltage min	V
114	Uavg_max	Average 3-phase voltage max	V
115	Iavg_min	Average 3-phase current min	A
116	Iavg_max	Average 3-phase current max	A
117	3P_min	3-phase active power min	W
118	3P_max	3-phase active power max	W
119	3Q_min	3-phase reactive power min	var
120	3Q_max	3-phase reactive power max	var
121	3S_min	3-phase apparent power min	VA
122	3S_max	3-phase apparent power max	VA
123	3PF_min	Power factor (PF) min	-
124	3PF_max	Power factor (PF) max	-
125	3tg_min	3-phase average min. ratio of reactive to active power	-
126	3tg_max	3-phase average max. ratio of reactive to active power	-
127	f_min	Frequency min	Hz
128	f_max	Frequency max	Hz
129	U123_min	Average phase-to-phase voltage min	V
130	U123_max	Average phase-to-phase voltage max	V
131	P DMD min	Averaged active power (P Demand) min	W
132	P DMD max	Averaged active power (P Demand) max	W

133	S DMD min	Averaged apparent power (S Demand) min	VA
134	S DMD max	Averaged apparent power (S Demand) max	VA
135	I_DMD min	Averaged current (I Demand) min	A
136	I_DMD max	Averaged current (I Demand) max	A
137	I_N min	Current in neutral wire min	A
138	I_N max	Current in neutral wire max	A
139	RESERVED	RESERVED	-
140	RESERVED	RESERVED	-
141	RESERVED	RESERVED	-
142	RESERVED	RESERVED	-
143	THD U1(U12) min	THD U1 min	%
144	THD U1(U12) max	THD U1 max	%
145	THD U2(U23) min	THD U2 min	%
146	THD U2(U23) max	THD U2 max	%
147	THD U3(U31) min	THD U3 min	%
148	THD U3(U31) max	THD U3 max	%
149	THD U min	THD U min	%
150	THD U max	THD U max	%
151	THD I1 min	THD I1 min	%
152	THD I1 max	THD I1 max	%
153	THD I2 min	THD I2 min	%
154	THD I2 max	THD I2 max	%
155	THD I3 min	THD I3 min	%
156	THD I3 max	THD I3 max	%
157	THD I min	THD I min	%
158	THD I max	THD I max	%
159	U1h2	2nd harmonics of voltage of L1 phase	%
...
207	U1h51	51st harmonics of voltage of L1 phase	%
208	U2h2	2nd harmonics of voltage of L2 phase	%
...
257	U2h51	51st harmonics of voltage of L2 phase	%
258	U3h2	2nd harmonics of voltage of L3 phase	%
...
307	U3h51	51st harmonics of voltage of L3 phase	%
308	I1h2	2nd harmonics of current of L1 phase	%
...
357	I1h51	51st harmonics of current of L1 phase	%
358	I2h2	2nd harmonics of current of L2 phase	%
...
407	I2h51	51st harmonics of current of L2 phase	%
408	I3h2	2nd harmonics of current of L3 phase	%

...
457	I3h51	51st harmonics of current of L3 phase	%
458	Q DMD	Averaged reactive power (Q Demand)	var
459	Q DMD min	Averaged reactive power (Q Demand) max	var
460	Q DMD max	Averaged reactive power (Q Demand) min	var
461	PFa	Average active power factor (PF1+PF2+PF3)/3)	-
462	PFa_min	Average active power factor min	-
463	PFa_max	Average active power factor max	-

* In 3-phase 3-wire system (3P/3W) accordingly THD U12, THD U23, THD U31, THD U123

9.2 Registers structure for RS-485 / Modbus interface

In the ND30BAC meter, data are placed in 16 and 32-bit registers. Process variables and meter parameters are placed in the address area of registers in a way depended on the variable value type. Bits in 16-bit register are numbered from the youngest to the oldest (b0-b15). The 32-bit registers contain numbers of float type in IEEE-754 standard. 3210 byte sequence - the oldest is sent first.

Table 16

Address range	Value type	Description
4000 – 4159	Integer (16 bits)	Value set in the 16-bit register. Registers for meter configuration. Description of registers is shown in Table 17. Registers for writing and readout.
4200 – 4260	Integer (16 bits)	Value set in the 16-bit register. Registers for configuration of programmable group of registers for readout. Description of registers is shown in Table 18. Registers for writing and readout.
4300 - 4385	Integer (16 bits)	Value set in the 16-bit register. Registers for displayed pages configuration. Description of registers is shown in Table 20. Registers for writing and readout.
4400- 4440	Integer (16 bits)	Value set in the 16-bit register. Status registers, energy value, MAC address of the meter, configuration data. Description of registers is shown in Table 21. Readout registers.
6000 – 6922	Float (2x16 bits)	Value is set in the two following 16-bit registers. Registers contain exactly the same data, as 32-bit registers of 7500 – 7953 range. Readout registers. Bytes sequence (1-0-3-2)
7000 - 7118	Float (2x16 bits)	Content of the registers set in the registers 4200 – 4359. Bytes sequence (3-2-1-0) (see table 19)
7200 – 7318	Float (2x16 bits)	Content of the registers set in the registers 4200 – 4359. Bytes sequence (1-0-3-2) (see table 19)
7400 - 7459	Float (32 bits)	Content of the registers set in the registers 4200 – 4359. Values set in one 32-bit register. (see table 19)
7500 – 7961	Float (32 bits)	Values set in one 32-bit register. Description of registers is shown in Table 22. Readout registers.
8000 - 8922	Float (2x16 bits)	Value is set in the two following 16-bit registers. Registers contain exactly the same data, as 32-bit registers of 7500 – 7953 range. Readout registers. Bytes sequence (3-2-1-0)

Table 17

Register address	Operations	Range	Description	Default
4000	RW	0...9999	Protection - password	0
4001	RW	0 .. 1	Type of connection 0 - 3Ph/4W 1 - 3Ph/3W 2 - 1Ph/2W	0
4002	RW	0 .. 2	Voltage on terminal 2 0 - first L1 phase voltage 1 - second L2 phase voltage 2 - third L3 phase voltage	0
4003	RW	0 .. 2	Voltage on terminal 5 0 - first L1 phase voltage 1 - second L2 phase voltage 2 - third L3 phase voltage	1
4004	RW	0 .. 2	Voltage on terminal 8 0 - first L1 phase voltage 1 - second L2 phase voltage 2 - third L3 phase voltage	2
4005	RW	0..5	Current on terminals 1, 3: 0 - first phase I_{L1} current 1 - reversed direction of the current of phase L1: $-I_{L1}$ 2 - second phase I_{L2} current 3 - reversed direction of the current of phase L2: $-I_{L2}$ 4 - third phase I_{L3} current 5 - reversed direction of the current of phase L3: $-I_{L3}$	0
4006	RW	0..5	Current on terminals 4, 6: 0 - first phase I_{L1} current 1 - reversed direction of the current of phase L1: $-I_{L1}$ 2 - second phase I_{L2} current 3 - reversed direction of the current of phase L2: $-I_{L2}$ 4 - third phase I_{L3} current 5 - reversed direction of the current of phase L3: $-I_{L3}$	2
4007	RW	0..5	Current on terminals 7, 9: 0 - first phase I_{L1} current 1 - reversed direction of the current of phase L1: $-I_{L1}$ 2 - second phase I_{L2} current 3 - reversed direction of the current of phase L2: $-I_{L2}$ 4 - third phase I_{L3} current 5 - reversed direction of the current of phase L3: $-I_{L3}$	4
4008	RW	0,1	Input current range: 1 A or 5 A: 0 - 1 A, 1 - 5 A	1
4009	RW	0,1	Input voltage range: 0 – 3 x 57.7/100 V; 1 – 3 x 230/400 V (version 1) 0 – 3 x 110/190 V; 1 – 3 x 400/690 V (version 2)	1
4010	RW	0..18	Transformer primary voltage, two older bytes	0
4011	RW	0..65535	Transformer primary voltage, two younger bytes	100
4012	RW	1 .. 10000	Transformer secondary voltage x 10	1000
4013	RW	1 .. 20000	Transformer primary current	5
4014	RW	1 .. 1000	Transformer secondary current	5
4015	RW	0...2	Averaging time of the active power P Demand apparent power S Demand current I Demand 0 – 15, 1- 30, 2- 60 minutes	0
4016	RW	0.1	Synchronization with real-time clock 0 - no synchronization 1 - synchronization with a clock	1
4017	RW		reserved	
4018	RW		reserved	
4019	RW		reserved	
4020	RW		reserved	

4021	RW		reserved	
4022	RW		reserved	
4023	RW		reserved	
4024	RW	0...4	Energy counters erasing 0 – no changes, 1 – erase active energies 2 – erase reactive energies, 3 – erase apparent energies, 4 – erase all energies	0
4025	RW	0.1	Erasing averaged parameters P Demand, S Demand, I Demand	0
4026	RW	0.1	Min, max erasing	0
4027	RW	0.1	Erasing alarm signalization latch	0
4028	RW		reserved	
4029	RW		reserved	
4030	RW	0...4	Alarm output 1 - Logic tasks of the conditions 1, 2, 3 0 – C1 1 – C1 v C2 v C3 2 – C1 ^ C2 ^ C3 3 – C1 ^ C2 v C3 4 – (C1 v C2 ^ C3	0
4031	RW	0,1	Alarm output 1 - State of the relay at the alarm switched on: 0 - relay disabled 1 - relay enabled	1
4032	RW	0,1	Alarm output 1 - alarm deactivation lock	0
4033	RW	0,1	Alarm output 1 - alarm signalization	0
4034	RW	0.1..43	Alarm output 1 - value for the condition 1 (c1) (code as in Table 8)	38
4035	RW	0..9	Alarm output 1 - type for the condition 1: 0 – n_on, 1 – noFF, 2 – on, 3 – oFF, 4 – H_on, 5 – HoFF, 6 – 3non, 7 – 3noF, 8 – 3_on, 9 – 3_oF	0
4036	RW	-1440..0..1440 [‰]	Alarm output 1 - lower value of the condition 1 switch of the rated input range	900
4037	RW	-1440..0..1440 [‰]	Alarm output 1 - upper value of the condition 1 switch of the rated input range	1100
4038	RW	0..3600 s	Alarm output 1 - condition 1 activation delay	0
4039	RW	0..3600 s	Alarm output 1 - condition 1 deactivation delay	0
4040	RW	0..3600 s	Alarm output 1 - condition 1 re-activation lock	0
4041	RW	0,1	Alarm output 1 - condition 1 signalization	0
4042	RW		reserved	
4043	RW	0.1..43	Alarm output 1 - value for the condition 2 (c2) (code as in Table 8)	38
4044	RW	0..9	Alarm output 1 - type for the condition 2: 0 – n_on, 1 – noFF, 2 – on, 3 – oFF, 4 – H_on, 5 – HoFF, 6 – 3non, 7 – 3noF, 8 – 3_on, 9 – 3_oF	0
4045	RW	-1440..0..1440 [‰]	Alarm output 1 - lower value of the condition 2 switch of the rated input range	900
4046	RW	-1440..0..1440 [‰]	Alarm output 1 - upper value of the condition 2 switch of the rated input range	1100
4047	RW	0..3600 s	Alarm output 1 - condition 2 activation delay	0
4048	RW	0..3600 s	Alarm output 1 - condition 2 deactivation delay	0
4049	RW	0..3600 s	Alarm output 1 - condition 2 re-activation lock	0
4050	RW	0,1	Alarm output 1 – condition 2 signalization	0
4051	RW		reserved	
4052	RW	0.1..43	Alarm output 1 - value for the condition 3 (c3) (code as in Table 8)	38
4053	RW	0..9	Alarm output 1 - type for the condition 3: 0 – n_on, 1 – noFF, 2 – on, 3 – oFF, 4 – H_on, 5 – HoFF, 6 – 3non, 7 – 3noF, 8 – 3_on, 9 – 3_oF	0
4054	RW	-1440..0..1440	Alarm output 1 - lower value of the condition 3 switch of the rated	900

		[%o]	input range	
4055	RW	-1440..0..1440 [%o]	Alarm output 1 - upper value of the condition 3 switch of the rated input range	1100
4056	RW	0..3600 s	Alarm output 1 - condition 3 activation delay	0
4057	RW	0..3600 s	Alarm output 1 - condition 3 deactivation delay	0
4058	RW	0..3600 s	Alarm output 1 - condition 2 re-activation lock	0
4059	RW	0,1	Alarm output 1- condition 2 signalization	0
4060	RW		reserved	
4061	RW	0..4	Alarm output 2 - Logic tasks of the conditions 1, 2, 3 0 – C1 1 – C1 v C2 v C3 2 – C1 ^ C2 ^ C3 3 – C1 ^ C2 v C3 4 – (C1 v C2 ^ C3	0
4062	RW	0,1	Alarm output 2 - State of the relay at the alarm switched on: 0 - relay disabled 1 - relay enabled	1
4063	RW	0,1	Alarm output 2 - alarm deactivation lock	0
4064	RW	0,1	Alarm output 2 - alarm signalization	0
4065	RW	0.1..43	Alarm output 2 - value for the condition 1 (c1) (code as in Table 8)	38
4066	RW	0..9	Alarm output 2 - type for the condition 1: 0 – n_on, 1 – noFF, 2 – on, 3 – oFF, 4 – H_on, 5 – HoFF, 6 – 3non, 7 – 3noF, 8 – 3_on, 9 – 3_oF	0
4067	RW	-1440..0..1440 [%o]	Alarm output 2 - lower value of the condition 1 switch of the rated input range	900
4068	RW	-1440..0..1440 [%o]	Alarm output 2 - upper value of the condition 1 switch of the rated input range	1100
4069	RW	0..3600 s	Alarm output 2 - condition 1 activation delay	0
4070	RW	0..3600 s	Alarm output 2 - condition 1 deactivation delay	0
4071	RW	0..3600 s	Alarm output 2 - condition 1 re-activation lock	0
4072	RW	0,1	Alarm output 2- condition 1 signalization	0
4073	RW		reserved	
4074	RW	0.1..43	Alarm output 2 - value for the condition 2 (c2) (code as in Table 8)	38
4075	RW	0..9	Alarm output 2 - type for the condition 2: 0 – n_on, 1 – noFF, 2 – on, 3 – oFF, 4 – H_on, 5 – HoFF, 6 – 3non, 7 – 3noF, 8 – 3_on, 9 – 3_oF	0
4076	RW	-1440..0..1440 [%o]	Alarm output 2 - lower value of the condition 2 switch of the rated input range	900
4077	RW	-1440..0..1440 [%o]	Alarm output 2 - upper value of the condition 2 switch of the rated input range	1100
4078	RW	0..3600 s	Alarm output 2 - condition 2 activation delay	0
4079	RW	0..3600 s	Alarm output 2 - condition 2 deactivation delay	0
4080	RW	0..3600 s	Alarm output 2 - condition 2 re-activation lock	0
4081	RW	0,1	Alarm output 2- condition 2 signalization	0
4082	RW		reserved	
4083	RW	0.1..43	Alarm output 2 - value for the condition 3 (c3) (code as in Table 8)	38
4084	RW	0..9	Alarm output 2 - type for the condition 3: 0 – n_on, 1 – noFF, 2 – on, 3 – oFF, 4 – H_on, 5 – HoFF, 6 – 3non, 7 – 3noF, 8 – 3_on, 9 – 3_oF	0
4085	RW	-1440..0..1440 [%o]	Alarm output 2 - lower value of the condition 3 switch of the rated input range	900
4086	RW	-1440..0..1440 [%o]	Alarm output 2 - upper value of the condition 3 switch of the rated input range	1100
4087	RW	0..3600 s	Alarm output 2 - condition 3 activation delay	0

4088	RW	0..3600 s	Alarm output 2 - condition 3 deactivation delay	0
4089	RW	0..3600 s	Alarm output 2 - condition 2 re-activation lock	0
4090	RW	0,1	Alarm output 2 - condition 2 signalization	0
4091	RW		reserved	
4092	RW	reserved	reserved	
4093	RW	reserved	reserved	
4094	RW	reserved	reserved	
4095	RW	reserved	reserved	
4096	RW	reserved	reserved	
4097	RW	reserved	reserved	
4098	RW	reserved	reserved	
4099	RW		reserved	
4100	RW	1..247	Modbus Network Address	1
4101	RW	0..3	Transmission mode: 0->8n2, 1->8e1, 2->8o1, 3->8n1	0
4102	RW	0..5	Baud rate: 0->4800, 1->9600 2->19200, 3->38400, 4->57600, 5->115200	1
4103	RW		reserved	
4104	RW	0.1	Upgrade change of transmission parameters	0
4105... 4130	RW		reserved	
4131	RW	0...65535	The third and the second byte (B3.B2) of the IP address of the meter, the IPv4 address format: B3.B2.B1.B0	49320 (0xC0 A8 = 192.1 68)
4132	RW	0...65535	The first and zero byte (B1.B0) of the IP address of the meter, the IPv4 address format: B3.B2.B1.B0	356 (0x01 64 = 1.100)
4133	RW	0...65535	The third and the second byte (B3.B2) of the subnet mask of the meter, the mask format: B3.B2.B1.B0	65535
4134	RW	0...65535	The first and zero byte (B1.B0) of the subnet mask of the meter, the mask format: B3.B2.B1.B0	65280
4135	RW	0...65535	The third and the second byte (B3.B2) of the default gateway of the meter, the gateway address format: B3.B2.B1.B0	49320
4136	RW	0...65535	The first and zero byte (B1.B0) of the default gateway of the meter, the gateway address format: B3.B2.B1.B0	257
4137	RW	0...65535	The third and the second byte (B3.B2) of the DNS address of the meter, the IPv4 address format: B3.B2.B1.B0	0x080 8=8.8
4138	RW	0...65535	The first and zero byte (B1.B0) of the DNS address of the meter, the IPv4 address format: B3.B2.B1.B0	0x080 8=8.8
4139	RW		reserved	
4140	RW		reserved	
4141	RW	0 .. 2	Baud rate of the Ethernet interface: 0 – automatic selection of the baud rate 1 – 10 Mb/s 2 – 100 Mb/s	0
4142... 4148	RW		reserved	
4149	RW	0,1	Saving the new parameters and initiate Ethernet interface 0 – no changes 1 - saving the new parameters and initiate the Ethernet interface	0
4150	RW	0..2	Menu language: 0-ENG, 1-PL, 2-DE	1
4151	RW	0,1	reserved	0
4152	RW	0.1	Saving default parameters (complete with resetting energy as well as min, max and mean power to 0) and Ethernet,	0
4153	RW	0..59	Seconds	0
4154	RW	0...2359	Hour *100 + minutes	0
4155	RW	101...1231	Month * 100 + day	101

4156	RW	2015...2077	Year	2015
4157	RW		reserved	
4158	RW		reserved	
4159	RW		reserved	

The alarm switching values stored in the registers 4036, 4037, 4054, 4055, 4067, 4068, 4076, 4077, 4085, 4086 are multiplied by 10, e.g. the value of 100% should be entered as "1000".

Table 18

Register address	Operations	Range	Description	Default
4200	RW	7500 .. 7957	Register 1 of programmable group of registers for readout	7500
4201	RW	7500 .. 7957	Register 2 of programmable group of registers for readout	7501
4202	RW	7500 .. 7957	Register 3 of programmable group of registers for readout	7502
4203	RW	7500 .. 7957	Register 4 of programmable group of registers for readout	7503
4204	RW	7500 .. 7957	Register 5 of programmable group of registers for readout	7504
4205	RW	7500 .. 7957	Register 6 of programmable group of registers for readout	7505
4206	RW	7500 .. 7957	Register 7 of programmable group of registers for readout	7506
4207	RW	7500 .. 7957	Register 8 of programmable group of registers for readout	7507
4208	RW	7500 .. 7957	Register 9 of programmable group of registers for readout	7508
4209	RW	7500 .. 7957	Register 10 of programmable group of registers for readout	7509
4210	RW	7500 .. 7957	Register 11 of programmable group of registers for readout	7510
4211	RW	7500 .. 7957	Register 12 of programmable group of registers for readout	7511
4212	RW	7500 .. 7957	Register 13 of programmable group of registers for readout	7512
4213	RW	7500 .. 7957	Register 14 of programmable group of registers for readout	7513
4214	RW	7500 .. 7957	Register 15 of programmable group of registers for readout	7514
4215	RW	7500 .. 7957	Register 16 of programmable group of registers for readout	7515
4216	RW	7500 .. 7957	Register 17 of programmable group of registers for readout	7516
4217	RW	7500 .. 7957	Register 18 of programmable group of registers for readout	7517
4218	RW	7500 .. 7957	Register 19 of programmable group of registers for readout	7518
4219	RW	7500 .. 7957	Register 20 of programmable group of registers for readout	7519
4220	RW	7500 .. 7957	Register 21 of programmable group of registers for readout	7520
4221	RW	7500 .. 7957	Register 22 of programmable group of registers for readout	7521
4222	RW	7500 .. 7957	Register 23 of programmable group of registers for readout	7522
4223	RW	7500 .. 7957	Register 24 of programmable group of registers for readout	7523
4224	RW	7500 .. 7957	Register 25 of programmable group of registers for readout	7524
4225	RW	7500 .. 7957	Register 26 of programmable group of registers for readout	7525
4226	RW	7500 .. 7957	Register 27 of programmable group of registers for readout	7526
4227	RW	7500 .. 7957	Register 28 of programmable group of registers for readout	7527
4228	RW	7500 .. 7957	Register 29 of programmable group of registers for readout	7528
4229	RW	7500 .. 7957	Register 30 of programmable group of registers for readout	7529
4230	RW	7500 .. 7957	Register 31 of programmable group of registers for readout	7530
4231	RW	7500 .. 7957	Register 32 of programmable group of registers for readout	7531
4232	RW	7500 .. 7957	Register 33 of programmable group of registers for readout	7532
4233	RW	7500 .. 7957	Register 34 of programmable group of registers for readout	7533
4234	RW	7500 .. 7957	Register 35 of programmable group of registers for readout	7534
4235	RW	7500 .. 7957	Register 36 of programmable group of registers for readout	7535
4236	RW	7500 .. 7957	Register 37 of programmable group of registers for readout	7536
4237	RW	7500 .. 7957	Register 38 of programmable group of registers for readout	7537
4238	RW	7500 .. 7957	Register 39 of programmable group of registers for readout	7538
4239	RW	7500 .. 7957	Register 40 of programmable group of registers for readout	7539
4240	RW	7500 .. 7957	Register 41 of programmable group of registers for readout	7540
4241	RW	7500 .. 7957	Register 42 of programmable group of registers for readout	7541
4242	RW	7500 .. 7957	Register 43 of programmable group of registers for readout	7542
4243	RW	7500 .. 7957	Register 44 of programmable group of registers for readout	7543
4244	RW	7500 .. 7957	Register 45 of programmable group of registers for readout	7544
4245	RW	7500 .. 7957	Register 46 of programmable group of registers for readout	7545

Register address	Operations	Range	Description	Default
4246	RW	7500 .. 7957	Register 47 of programmable group of registers for readout	7546
4247	RW	7500 .. 7957	Register 48 of programmable group of registers for readout	7547
4248	RW	7500 .. 7957	Register 49 of programmable group of registers for readout	7548
4249	RW	7500 .. 7957	Register 50 of programmable group of registers for readout	7549
4250	RW	7500 .. 7957	Register 51 of programmable group of registers for readout	7550
4251	RW	7500 .. 7957	Register 52 of programmable group of registers for readout	7551
4252	RW	7500 .. 7957	Register 53 of programmable group of registers for readout	7552
4253	RW	7500 .. 7957	Register 54 of programmable group of registers for readout	7553
4254	RW	7500 .. 7957	Register 55 of programmable group of registers for readout	7554
4255	RW	7500 .. 7957	Register 56 of programmable group of registers for readout	7559
4256	RW	7500 .. 7957	Register 57 of programmable group of registers for readout	7560
4257	RW	7500 .. 7957	Register 58 of programmable group of registers for readout	7561
4258	RW	7500 .. 7957	Register 59 of programmable group of registers for readout	7566
4259	RW	7500 .. 7957	Register 60 of programmable group of registers for readout	7567
4260	RW	0,1	Restore default group 0 – no changes, 1 – restore default group	0

Table 19

16-bit register address 2x16 1032/ 2x16 3210	Register address 32-bit	Operations	Description
7200/7000	7400	R	Content of the register set in the registers 4200
7202/7002	7401	R	Content of the register set in the registers 4201
7204/7004	7402	R	Content of the register set in the registers 4202
7206/7006	7403	R	Content of the register set in the registers 4203
7208/7008	7404	R	Content of the register set in the registers 4204
7210/7010	7405	R	Content of the register set in the registers 4205
7212/7012	7406	R	Content of the register set in the registers 4206
7214/7014	7407	R	Content of the register set in the registers 4207
7216/7016	7408	R	Content of the register set in the registers 4208
7218/7018	7409	R	Content of the register set in the registers 4209
7220/7020	7410	R	Content of the register set in the registers 4210
7222/7022	7411	R	Content of the register set in the registers 4211
7224/7024	7412	R	Content of the register set in the registers 4212
7226/7026	7413	R	Content of the register set in the registers 4213
7228/7028	7414	R	Content of the register set in the registers 4214
7230/7030	7415	R	Content of the register set in the registers 4215
7232/7032	7416	R	Content of the register set in the registers 4216
7234/7034	7417	R	Content of the register set in the registers 4217
7236/7036	7418	R	Content of the register set in the registers 4218
7238/7038	7419	R	Content of the register set in the registers 4219
7240/7040	7420	R	Content of the register set in the registers 4220
7242/7042	7421	R	Content of the register set in the registers 4221
7244/7044	7422	R	Content of the register set in the registers 4222
7246/7046	7423	R	Content of the register set in the registers 4223
7248/7048	7424	R	Content of the register set in the registers 4224
7250/7050	7425	R	Content of the register set in the registers 4225
7252/7052	7426	R	Content of the register set in the registers 4226
7254/7054	7427	R	Content of the register set in the registers 4227
7256/7056	7428	R	Content of the register set in the registers 4228
7258/7058	7429	R	Content of the register set in the registers 4229
7260/7060	7430	R	Content of the register set in the registers 4230
7262/7062	7431	R	Content of the register set in the registers 4231
7264/7064	7432	R	Content of the register set in the registers 4232
7266/7066	7433	R	Content of the register set in the registers 4233

7268/7068	7434	R	Content of the register set in the registers 4234
7270/7070	7435	R	Content of the register set in the registers 4235
7272/7072	7436	R	Content of the register set in the registers 4236
7274/7074	7437	R	Content of the register set in the registers 4237
7276/7076	7438	R	Content of the register set in the registers 4238
7278/7078	7439	R	Content of the register set in the registers 4239
7280/7080	7440	R	Content of the register set in the registers 4240
7282/7082	7441	R	Content of the register set in the registers 4241
7284/7084	7442	R	Content of the register set in the registers 4242
7286/7086	7443	R	Content of the register set in the registers 4243
7288/7088	7444	R	Content of the register set in the registers 4244
7290/7090	7445	R	Content of the register set in the registers 4245
7292/7092	7446	R	Content of the register set in the registers 4246
7294/7094	7447	R	Content of the register set in the registers 4247
7296/7096	7448	R	Content of the register set in the registers 4248
7298/7098	7449	R	Content of the register set in the registers 4249
7300/7100	7450	R	Content of the register set in the registers 4250
7302/7102	7451	R	Content of the register set in the registers 4251
7304/7104	7452	R	Content of the register set in the registers 4252
7306/7106	7453	R	Content of the register set in the registers 4253
7308/7108	7454	R	Content of the register set in the registers 4254
7310/7110	7455	R	Content of the register set in the registers 4255
7312/7112	7456	R	Content of the register set in the registers 4256
7314/7114	7457	R	Content of the register set in the registers 4257
7316/7116	7458	R	Content of the register set in the registers 4258
7318/7118	7459	R	Content of the register set in the registers 4259

Table 20

Register address	Operations	Range	Description	Default
4300	RW	1...3	Luminosity level: 1 – Minimum, 2 - Medium 3 - Maximum	3
4301	RW	0 .. 3600	Time to min. luminosity	0
4302	RW		reserved	0
4303	RW	0x0001...0x03FF	Enabling page display Bit0 – page 1, Bit1 – page 2, ...Bit9 – page 10	0x03FF
4304	RW		reserved	
4305	RW	00..49	Page 1 display 1, U1	1
4306	RW	00..49	Page 1 display 2, U2	10
4307	RW	00..49	Page 1 display 3, U3	19
4308	RW	00..49	Page 1 display 4, f	37
4309	RW	00..49	Page 1 display 5, I1	2
4310	RW	00..49	Page 1 display 6, I2	11
4311	RW	00..49	Page 1 display 7, I3	20
4312	RW	00..49	Page 1 display 8, I avg	28
4313	RW	00..49	Page 2 display 1, U12	38
4314	RW	00..49	Page 2 display 2, U23	39
4315	RW	00..49	Page 2 display 3, U31	40
4316	RW	00..49	Page 2 display 4, U123	41
4317	RW	00..49	Page 2 display 5, ΣP	30
4318	RW	00..49	Page 2 display 6, ΣQ	31
4319	RW	00..49	Page 2 display 7, ΣS	32
4320	RW	00..49	Page 2 display 8, PF avg	33
4321	RW	00..49	Page 3 display 1, P1	3
4322	RW	00..49	Page 3 display 2, P2	12
4323	RW	00..49	Page 3 display 3, P3	21

Register address	Operations	Range	Description	Default
4324	RW	00..49	Page 3 display 4, Σ P	30
4325	RW	00..49	Page 3 display 5, PF1	6
4326	RW	00..49	Page 3 display 6, PF2	15
4327	RW	00..49	Page 3 display 7, PF3	24
4328	RW	00..49	Page 3 display 8, PF avg	33
4329	RW	00..49	Page 4 display 1, P1	3
4330	RW	00..49	Page 4 display 2, P2	12
4331	RW	00..49	Page 4 display 3, P3	21
4332	RW	00..49	Page 4 display 4, Σ P	30
4333	RW	00..49	Page 4 display 5, Q1	4
4334	RW	00..49	Page 4 display 6, Q2	13
4335	RW	00..49	Page 4 display 7, Q3	22
4336	RW	00..49	Page 4 display 8, Σ Q	31
4337	RW	00..49	Page 5 display 1, THD U1	8
4338	RW	00..49	Page 5 display 2, THD U2	17
4339	RW	00..49	Page 5 display 3, THD U3	26
4340	RW	00..49	Page 5 display 4, THD U	35
4341	RW	00..49	Page 5 display 5, THD I1	9
4342	RW	00..49	Page 5 display 6, THD I2	18
4343	RW	00..49	Page 5 display 7, THD I3	27
4344	RW	00..49	Page 5 display 8, THD I	36
4345	RW	00..49	Page 6 display 1, U1	1
4346	RW	00..49	Page 6 display 2, I1	2
4347	RW	00..49	Page 6 display 3, P1	3
4348	RW	00..49	Page 6 display 4, Q1	4
4349	RW	00..49	Page 6 display 5, S1	5
4350	RW	00..49	Page 6 display 6, PF1	6
4351	RW	00..49	Page 6 display 7, tg1	7
4352	RW	00..49	Page 6 display 8, f	37
4353	RW	00..49	Page 7 display 1, U2	10
4354	RW	00..49	Page 7 display 2, I2	11
4355	RW	00..49	Page 7 display 3, P2	12
4356	RW	00..49	Page 7 display 4, Q2	13
4357	RW	00..49	Page 7 display 5, S2	14
4358	RW	00..49	Page 7 display 6, PF2	15
4359	RW	00..49	Page 7 display 7, tg2	16
4360	RW	00..49	Page 7 display 8, f	37
4361	RW	00..49	Page 8 display 1, U3	19
4362	RW	00..49	Page 8 display 2, I3	20
4363	RW	00..49	Page 8 display 3, P3	21
4364	RW	00..49	Page 8 display 4, Q3	22
4365	RW	00..49	Page 8 display 5, S3	23
4366	RW	00..49	Page 8 display 6, PF3	24
4367	RW	00..49	Page 8 display 7, tg3	25
4368	RW	00..49	Page 8 display 8, f	37
4369	RW	00..49	Page 9 display 1, Σ P	30
4370	RW	00..49	Page 9 display 2, Σ Q	31
4371	RW	00..49	Page 9 display 3, I avg	29
4372	RW	00..49	Page 9 display 4, I(N)	45
4373	RW	00..49	Page 9 display 5, P DMD	42
4374	RW	00..49	Page 9 display 6, S DMD	43
4375	RW	00..49	Page 9 display 7, I DMD	44
4376	RW	00..49	Page 9 display 8, f	37
4377	RW	00..49	Page 10 display 1, Σ P	30

Register address	Operations	Range	Description	Default
4378	RW	00..49	Page 10 display 2, ΣQ	31
4379	RW	00..49	Page 10 display 3, ΣS	32
4380	RW	00..49	Page 10 display 4, En S	52
4381	RW	00..49	Page 10 display 5, +En P	48
4382	RW	00..49	Page 10 display 6, -En P	49
4383	RW	00..49	Page 10 display 7, ξ En Q	50
4384	RW	00..49	Page 10 display 8, \oplus En Q	51
4385	RW	0..3	Restore manufacturer's pages 0 - no 1 - 3Ph/4W 2 - 3Ph/3W 3 - 1PH/2W	0

Table 21

Register address	Operations	Range	Description	Default
4400	R		reserved	
4401	R	0..65535	Identifier	D9
4402	R	0..65535	Bootloader version x 100	-
4403	R	0..65535	Program version x100	-
4404	R		reserved	
4405	R	0..65535	Ordering codes	-
4406	R	0..65535	Nominal voltage x10	577/2300
4407	R	0..65535	Nominal voltage x10	1100/4000
4408	R	0..65535	Nominal current (1 A) x 100	100
4409	R	0..65535	Nominal current (5 A) x 100	500
4410	R		reserved	
4411	R	0..65535	Seventh and sixth byte (B7.B6) of a serial number, format B7:B6:B5:B4:B3:B2:B1:B0	-
4412	R	0..65535	Fifth and fourth byte (B5.B4) of a serial number, format B7:B6:B5:B4:B3:B2:B1:B0	-
4413	R	0..65535	Third and second byte (B3.B2) of a serial number, format B7:B6:B5:B4:B3:B2:B1:B0	-
4414	R	0..65535	First and zero byte (B1.B0) of a serial number, format B7:B6:B5:B4:B3:B2:B1:B0	-
4415	R	0..65535	Status 1 Register – see description below	0
4416	R	0..65535	Status 2 Register – see description below	0
4417	R	0..65535	Status 3 Register – see description below	0
4418	R	0..65535	Status 4 Register – see description below	0
4419	R	0..65535	Status 5 Register – see description below	0
4420	R	0..65535	Status 6 Register – see description below	0
4421	R	0...65535	Fifth and fourth byte (B5.B4) of MAC address of the meter, format B5:B4:B3:B2:B1:B0	-
4422	R	0...65535	Third and second byte (B3.B2) of MAC address of the meter, format B5:B4:B3:B2:B1:B0	-
4423	R	0...65535	The fifth and fourth byte (B1.B0) of MAC address of the meter, format B5:B4:B3:B2:B1:B0	-
4424	R		reserved	0
4425	R		reserved	0
4426	R	0..152	Active import energy, two older bytes	0
4427	R	0..65535	Active import energy, two younger bytes	0
4428	R	0..152	Active export energy, two older bytes	0
4429	R	0..65535	Active export energy, two younger bytes	0
4430	R	0..152	Reactive inductive energy, two older bytes	0
4431	R	0..65535	Reactive inductive energy, two younger bytes	0

4432	R	0..152	Reactive capacity energy, two older bytes	0
4433	R	0..65535	Reactive capacity energy, two younger bytes	0
4434	R	0..152	Apparent energy, two older bytes	0
4435	R	0..65535	Apparent energy, two younger bytes	0
4436	R		reserved	
4437	R		reserved	
4438	R		reserved	-
4439	R		reserved	-
4440... 4446	R		Reserved	

Energy is made available in hundreds of watt-hours (var-hours) in double 16-bit register, and for this reason, you should divide them by 100 when calculating values of particular energy from registers, e.g.:

Active import energy = (reg. value 4426 x 65536 + reg. value 4427) / 100 [kWh]

Active export energy = (reg. value 4428 x 65536 + reg. value 4429) / 100 [kWh]

Reactive inductive energy = (reg. value 4430 x 65536 + reg. value 4431) / 100 [kVarh]

Reactive capacity energy = (reg. value 4432 x 65536 + reg. value 4433) / 100 [kVarh]

Apparent energy = (reg. value 4434 x 65536 + reg. value 4435) / 100 [kVAh]

Status 1 Register of a device (address 4415, R):

Bit 15 – "1" – FRAM memory damage

Bit 14 – "1" – no calibration of the input

Bit 13 – "1" – no calibration of the output

Bit 12 – "1" – reserved

Bit 11 – "1" – error in configuration registers

Bit 10 – "1" – error in displayed pages registers

Bit 9 – "1" – error in registers for configuration of programmable group of registers for readout

Bit 8 – "1" – energy value error

Bit 7 – "1" – phase sequence error

Bit 6 – "1" – reserved

Bit 5 – "1" – reserved

Bit 4 – "1" – present analog output

Bit 3 – "1" – reserved

Bit 2 – "1" – present Ethernet and internal memory

Bit 1 – "1" – used battery of RTC

Bit 0 – reserved

Status 2 Register – (address 4416, R):

Bit 15 – "1" – condition 3 for alarm 2 signalization

Bit 14 – "1" – condition 2 for alarm 2 signalization

Bit 13 – "1" – condition 1 for alarm 2 signalization

Bit 12 – "1" – alarm 2 signalization

Bit 11 – "1" – alarm 2 condition 3 activated

Bit 10 – "1" – alarm 2 condition 2 activated

Bit 9 – "1" – alarm 2 condition 1 activated

Bit 8 – "1" – alarm 2 activated

Bit 7 – "1" – condition 3 for alarm 1 signalization

Bit 6 – "1" – condition 2 for alarm 1 signalization

Bit 5 – "1" – condition 1 for alarm 1 signalization

Bit 4 – "1" – alarm 1 signalization

Bit 3 – "1" – alarm 1 condition 3 activated

Bit 2 – "1" – alarm 1 condition 2 activated

Bit 1 – "1" – alarm 1 condition 1 activated

Bit 0 – "1" – alarm 1 activated

Status 3 Register – (address 4417, R): Files archive status

Bit 15 – Ethernet connected

Bit 14 – reserved

Bit 13 – reserved

Bit 12 – reserved

Bit 11 – "0" - waiting for the archiving conditions to be met
"1" - archiving in the archiving group 2

Bit 10 – "0" - waiting for the archiving conditions to be met
"1" - archiving in the archiving group 1

Bit 9 – reserved

Bit 8 – Archiving group 2 enabled

Bit 7 – Archiving group 1 enabled

Bit 6 – reserved

Bit 5 – copying of internal memory to
files archive from archiving group 2

Bit 4 – copying of internal memory to
files archive from archiving group 1

Bit 3 – Files archive space is full, (less then 14
days at 1 sec. interval to completely use a the files
archive space)

Bit 2 – 70% of files archive space is full

Bit 1 – Files archive initialized correctly

Bit 0 – Files archive file system error

Status 4 Register – (address 4418, R) reactive power characteristics:

Bit 15 – measurement with phase L3 synchronization	Bit 7 – "1" – capacity L3 min.
Bit 14 – measurement with phase L2 synchronization	Bit 6 – "1" – capacity L3
Bit 13 – measurement with phase L1 synchronization	Bit 5 – "1" – capacity L2 max.
Bit 12 – measurement with current synchronization	Bit 4 – "1" – capacity L2 min.
Bit 11 – "1" – capacity 3L max.	Bit 3 – "1" – capacity L2
Bit 10 – "1" – capacity 3L min.	Bit 2 – "1" – capacity L1 max.
Bit 9 – "1" – capacity 3L	Bit 1 – "1" – capacity L1 min.
Bit 8 – "1" – leading L3 max.	Bit 0 – "1" – capacity L1

Status 5 Register – (address 4419, R)

Bit 8 – "1" – alarm 1 condition 3 for phase L3 active
Bit 7 – "1" – alarm 1 condition 3 for phase L2 active
Bit 6 – "1" – alarm 1 condition 3 for phase L1 active
Bit 5 – "1" – alarm 1 condition 2 for phase L3 active
Bit 4 – "1" – alarm 1 condition 2 for phase L2 active
Bit 3 – "1" – alarm 1 condition 2 for phase L1 active
Bit 2 – "1" – alarm 1 condition 1 for phase L3 active
Bit 1 – "1" – alarm 1 condition 1 for phase L2 active
Bit 0 – "1" – alarm 1 condition 1 for phase L1 active

Status 6 Register – (address 4420, R)

Bit 8 – "1" – alarm 2 condition 3 for phase L3 active
Bit 7 – "1" – alarm 2 condition 3 for phase L2 active
Bit 6 – "1" – alarm 2 condition 3 for phase L1 active
Bit 5 – "1" – alarm 2 condition 2 for phase L3 active
Bit 4 – "1" – alarm 2 condition 2 for phase L2 active
Bit 3 – "1" – alarm 2 condition 2 for phase L1 active
Bit 2 – "1" – alarm 2 condition 1 for phase L3 active
Bit 1 – "1" – alarm 2 condition 1 for phase L2 active
Bit 0 – "1" – alarm 2 condition 1 for phase L1 active

Table 22

16-bit register address 2x16 1032/ 2x16 3210	Register address 32-bit	Operations	Description	Unit	3Ph / 4W	3Ph / 3W	1Ph / 2W
6000/8000	7500	R	L1 phase voltage	V	√	x	√
6002/8002	7501	R	L1 phase current	A	√	√	√
6004/8004	7502	R	L1 phase active power	W	√	x	√
6006/8006	7503	R	L1 phase reactive power	VA _r	√	x	√
6008/8008	7504	R	L1 phase apparent power	VA	√	x	√
6010/8010	7505	R	L1 phase active power factor (PF1=P1/S1))	-	√	x	√
6012/8012	7506	R	tgφ factor of L1 phase (tg1=Q1/P1)	-	√	x	√
6014/8014	7507	R	THD U1*	%	√	x	√
6016/8016	7508	R	THD I1	%	√	x	√
6018/8018	7509	R	L2 phase voltage	V	√	x	x
6020/8020	7510	R	L2 phase current	A	√	√	x
6022/8022	7511	R	L2 phase active power	W	√	x	x
6024/8024	7512	R	L2 phase reactive power	VA _r	√	x	x
6026/8026	7513	R	L2 phase apparent power	VA	√	x	x
6028/8028	7514	R	L2 phase active power factor (PF2=P2/S2))	-	√	x	x
6030/8030	7515	R	tgφ factor of L2 phase (tg2=Q2/P2)	-	√	x	x

6032/8032	7516	R	THD U2*	%	√	x	x
6034/8034	7517	R	THD I2	%	√	x	x
6036/8036	7518	R	L3 phase voltage	V	√	x	x
6038/8038	7519	R	L3 phase current	A	√	√	x
6040/8040	7520	R	L3 phase active power	W	√	x	x
6042/8042	7521	R	L3 phase reactive power	VAr	√	x	x
6044/8044	7522	R	L3 phase apparent power	VA	√	x	x
6046/8046	7523	R	L3 phase active power factor (PF3=P3/S3))	-	√	x	x
6048/8048	7524	R	tgφ factor of L3 phase (tg3=Q3/P3)	-	√	x	x
6050/8050	7525	R	THD U3*	%	√	x	x
6052/8052	7526	R	THD I3	%	√	x	x
6054/8054	7527	R	Mean 3-phase voltage	V	√	x	x
6056/8056	7528	R	Mean 3-phase current	A	√	√	x
6058/8058	7529	R	3-phase active power (P1+P2+P3)	W	√	√	x
6060/8060	7530	R	3-phase reactive power (Q1+Q2+Q3)	VAr	√	√	x
6062/8062	7531	R	3-phase apparent power (S1+S2+S3)	VA	√	√	x
6064/8064	7532	R	3-phase active power factor (PF=P/S)	-	√	√	x
6066/8066	7533	R	Mean tg factor φ for 3 phases (tg=Q/P)	-	√	√	x
6068/8068	7534	R	THD U* mean 3-phase	%	√	x	x
6070/8070	7535	R	THD I mean 3-phase	%	√	x	x
6072/8072	7536	R	Frequency	f	√	√	√
6074/8074	7537	R	Phase-to-phase voltage L ₁₋₂	V	√	√	x
6076/8076	7538	R	Phase-to-phase voltage L ₂₋₃	V	√	√	x
6078/8078	7539	R	Phase-to-phase voltage L ₃₋₁	V	√	√	x
6080/8080	7540	R	Mean phase-to-phase voltage	V	√	√	x
6082/8082	7541	R	Active power averaged (P Demand)	W	√	√	x
6084/8084	7542	R	Reactive power averaged (S Demand)	VA	√	√	x
6086/8086	7543	R	Current averaged (I Demand)	A	√	√	x
6088/8088	7544	R	Neutral wire current (calculated from vectors)	A	√	x	x
6090/8090	7545	R	Active 3-phase import energy (no. of register 7546 overflows, resets to 0 after reaching 9999.9 MWh)	100 MWh	√	√	√
6092/8092	7546	R	Active 3-phase import energy (counter counting up to 99999.99 kWh)	kWh	√	√	√
6094/8094	7547	R	Active 3-phase export energy (no. of register 7548 overflows, resets to 0 after reaching 9999.9 MWh)	100 MWh	√	√	√
6096/8096	7548	R	Active 3-phase export energy (counter counting up to 99999.99 kWh)	kWh	√	√	√
6098/8098	7549	R	Reactive 3-phase inductive energy (no. of register 7550 overflows, resets to 0 after reaching 9999.9 MVAh).	100 MVAh	√	√	√
6100/8100	7550	R	Reactive 3-phase inductive energy (counter counting up to 99999.99 kVAh)	kVAh	√	√	√
6102/8102	7551	R	Reactive 3-phase capacity energy (no. of register 7552 overflows, resets to 0 after reaching 9999.9 MVAh)	100 MVAh	√	√	√
6104/8104	7552	R	Reactive 3-phase capacity energy (counter counting up to 99999.99 kVAh)	kVAh	√	√	√
6106/8106	7553	R	Apparent energy (no. of register 7554 overflows, resets to 0 after reaching 9999.9 MVAh)	100 MVAh	√	√	√
6108/8108	7554	R	Apparent energy (counter counting up to 99999.99 kVAh)	kVAh	√	√	√
6110/8110	7555	R	Time – seconds	sec	√	√	√
6112/8112	7556	R	Time – hours, minutes		√	√	√
6114/8114	7557	R	Date – month, day		√	√	√
6116/8116	7558	R	Year – 2014 - 2100		√	√	√
6118/8118	7559	R	Status 1 register	-	√	√	√
6120/8120	7560	R	Status 2 register	-	√	√	√

6122/8122	7561	R	Status 3 register	-	√	√	√
6124/8124	7562	R	Status 4 register	-	√	√	√
6126/8126	7563	R	Status 5 register	-	√	√	√
6128/8128	7564	R	Status 6 register	-	√	√	√
6130/7130	7565	R	reserved	-	√	√	√
6132/8132	7566	R	reserved	°C	√	√	√
6134/8134	7567	R	reserved	°C	√	√	√
6136/8136	7568	R	Voltage L1 min	V	√	x	√
6138/8138	7569	R	Voltage L1 max	V	√	x	√
6140/8140	7570	R	Voltage L2 min	V	√	x	x
6142/8142	7571	R	Voltage L2 max	V	√	x	x
6144/8144	7572	R	Voltage L3 min	V	√	x	x
6146/8146	7573	R	Voltage L3 max	V	√	x	x
6148/8148	7574	R	Current L1 min	A	√	√	x
6150/8150	7575	R	Current L1 max	A	√	√	x
6152/8152	7576	R	Current L2 min	A	√	√	x
6154/8154	7577	R	Current L2 max	A	√	√	x
6156/8156	7578	R	Current L3 min	A	√	√	x
6158/8158	7579	R	Current L3 max	A	√	√	x
6160/8160	7580	R	Active power L1 min	W	√	x	√
6162/8162	7581	R	Active power L1 max	W	√	x	√
6164/8164	7582	R	Active power L2 min	W	√	x	x
6166/8166	7583	R	Active power L2 max	W	√	x	x
6168/8168	7584	R	Active power L3 min	W	√	x	x
6170/8170	7585	R	Active power L3 max	W	√	x	x
6172/8172	7586	R	Reactive power L1 min	Var	√	x	√
6174/8174	7587	R	Reactive power L1 max	Var	√	x	√
6176/8176	7588	R	Reactive power L2 min	Var	√	x	x
6178/8178	7589	R	Reactive power L2 max	Var	√	x	x
6180/8180	7590	R	Reactive power L3 min	Var	√	x	x
6182/8182	7591	R	Reactive power L3 max	Var	√	x	x
6184/8184	7592	R	Apparent power L1 min	VA	√	x	√
6186/8186	7593	R	Apparent power L1 max	VA	√	x	√
6188/8188	7594	R	Apparent power L2 min	VA	√	x	x
6190/8190	7595	R	Apparent power L2 max	VA	√	x	x
6192/8192	7596	R	Apparent power L3 min	VA	√	x	x
6194/8194	7597	R	Apparent power L3 max	VA	√	x	x
6196/8196	7598	R	Power factor (PF) L1 min	-	√	x	√
6198/8198	7599	R	Power factor (PF) L1 max	-	√	x	√
6200/8200	7600	R	Power factor (PF) L2 min	-	√	x	x
6202/8202	7601	R	Power factor (PF) L2 max	-	√	x	x
6204/8204	7602	R	Power factor (PF) L3 min	-	√	x	x
6206/8206	7603	R	Power factor (PF) L3 max	-	√	x	x
6208/8208	7604	R	Reactive to active power ratio L1 min	-	√	x	√
6210/8210	7605	R	Reactive to active power ratio L1 max	-	√	x	√
6212/8212	7606	R	Reactive to active power ratio L1 min	-	√	x	x
6214/8214	7607	R	Reactive to active power ratio L2 max	-	√	x	x
6216/8216	7608	R	Reactive to active power ratio L3 min	-	√	x	x
6218/8218	7609	R	Reactive to active power ratio L3 max	-	√	x	x
6220/8220	7610	R	Phase-to-phase voltage L ₁₋₂ min	V	√	√	x
6222/8222	7611	R	Phase-to-phase voltage L ₁₋₂ max	V	√	√	x
6224/8224	7612	R	Phase-to-phase voltage L ₂₋₃ min	V	√	√	x
6226/8226	7613	R	Phase-to-phase voltage L ₂₋₃ max	V	√	√	x

6228/8228	7614	R	Phase-to-phase voltage L ₃₋₁ min	V	√	√	x
6230/8230	7615	R	Phase-to-phase voltage L ₃₋₁ max	V	√	√	x
6232/8232	7616	R	Mean 3-phase voltage (min)	V	√	x	x
6234/8234	7617	R	Mean 3-phase voltage (max)	V	√	x	x
6236/8236	7618	R	Mean 3-phase current (min)	A	√	√	x
6238/8238	7619	R	Mean 3-phase current (max)	A	√	√	x
6240/8240	7620	R	3-phase active power (min)	W	√	√	x
6242/8242	7621	R	3-phase active power (max)	W	√	√	x
6244/8244	7622	R	3-phase reactive power (min)	var	√	√	x
6246/8246	7623	R	3-phase reactive power (max)	var	√	√	x
6248/8248	7624	R	3-phase apparent power (min)	VA	√	√	x
6250/8250	7625	R	3-phase apparent power (max)	VA	√	√	x
6252/8252	7626	R	Power factor (PF) min	-	√	√	x
6254/8254	7627	R	Power factor (PF) max	-	√	√	x
6256/8256	7628	R	Reactive to active power ratio (3-phase mean min.)	-	√	√	x
6258/8258	7629	R	Reactive to active power ratio (3-phase mean max.)	-	√	√	x
6260/8260	7630	R	Min. frequency	Hz	√	√	√
6262/8262	7631	R	Frequency max	Hz	√	√	√
6264/8264	7632	R	Mean phase-to-phase voltage (min.)	V	√	√	x
6266/8266	7633	R	Mean phase-to-phase voltage (max.)	V	√	√	x
6268/8268	7634	R	Active power averaged (P Demand) min	W	√	√	√
6270/8270	7635	R	Active power averaged (P Demand) max	W	√	√	√
6272/8272	7636	R	Apparent power averaged (S Demand) min	VA	√	√	√
6274/8274	7637	R	Apparent power averaged (S Demand) max	VA	√	√	√
6276/8276	7638	R	Current averaged (I Demand) min	A	√	√	√
6278/8278	7639	R	Current averaged (I Demand) max	A	√	√	√
6280/8280	7640	R	Neutral wire current (min.)	A	√	x	x
6282/8282	7641	R	Neutral wire current (max.)	A	√	x	x
6284/8284	7642	R	reserved	-	√	√	√
6286/8286	7643	R	reserved	-	√	√	√
6288/8288	7644	R	reserved	-	√	√	√
6290/8290	7645	R	reserved	-	√	√	√
6292/8292	7646	R	THD U1 min	%	√	x	√
6294/8294	7647	R	THD U1 max	%	√	x	√
6296/8296	7648	R	THD U2 min	%	√	x	x
6298/8298	7649	R	THD U2 max	%	√	x	x
6300/8300	7650	R	THD U3 min	%	√	x	x
6302/8302	7651	R	THD U3 max	%	√	x	x
6304/8304	7652	R	THD U min	%	√	x	x
6306/8306	7653	R	THD U max	%	√	x	x
6308/8308	7654	R	THD I1 min	%	√	x	√
6310/8310	7655	R	THD I1 max	%	√	x	√
6312/8312	7656	R	THD I2 min	%	√	x	x
6314/8314	7657	R	THD I2 max	%	√	x	x
6316/8316	7758	R	THD I3 min	%	√	x	x
6318/8318	7759	R	THD I3 max	%	√	x	x
6320/8320	7660	R	THD I min	%	√	x	x
6322/8322	7661	R	THD I max	%	√	x	x
6324/8324	7662	R	HarU1[2] 2nd harmonic of L1 phase voltage	%	√	x	√
6326/8326	7663	R	HarU1[3] 3rd harmonic of L1 phase voltage	%	√	x	√
:	:	R	:				
:	:	R	:				

6420/8420	7710	R	HarU1[50] 50th harmonic of L1 phase voltage	%	√	x	√
6422/8422	7711	R	HarU1[51] 51st harmonic of L1 phase voltage	%	√	x	√
6424/8424	7712	R	HarU2[2] 2nd harmonic of L2 phase voltage	%	√	x	x
6426/8426	7713	R	HarU2[3] 3rd harmonic of L2 phase voltage	%	√	x	x
:	:	R	:				
:	:	R	:				
6520/8520	7760	R	HarU2[50] 50th harmonic of L2 phase voltage	%	√	x	x
6522/8522	7761	R	HarU2[51] 51st harmonic of L2 phase voltage	%	√	x	x
6524/8524	7762	R	HarU3[2] 2nd harmonic of L3 phase voltage	%	√	x	x
6526/8526	7763	R	HarU3[3] 3rd harmonic of L3 phase voltage	%	√	x	x
:	:	R	:				
:	:	R	:				
6620/8620	7810	R	HarU3[50] 50th harmonic of L3 phase voltage	%	√	x	x
6622/8622	7811	R	HarU3[51] 51st harmonic of L3 phase voltage	%	√	x	x
6624/8624	7812	R	HarI1U1[2] 2nd harmonic of L1 phase current	%	√	x	√
6626/8626	7813	R	HarI1U1[3] 3rd harmonic of L1 phase current	%	√	x	√
:	:	R	:				
:	:	R	:				
6720/8720	7860	R	HarI1U1[50] 50th harmonic of L1 phase current	%	√	x	√
6722/8722	7861	R	HarI1[51] 51st harmonic of L1 phase current	%	√	x	√
6724/8724	7862	R	HarI2[2] 2nd harmonic of L2 phase current	%	√	x	x
6726/8726	7863	R	HarI2[3] 3rd harmonic of L2 phase current	%	√	x	x
:	:	R	:				
:	:	R	:				
6820/8820	7910	R	HarI2[50] 50th harmonic of L2 phase current	%	√	x	x
6822/8822	7911	R	HarI2[51] 51st harmonic of L2 phase current	%	√	x	x
6824/8824	7912	R	HarI3[2] 2nd harmonic of L3 phase current	%	√	x	x
6826/8826	7913	R	HarI3[3] 3rd harmonic of L3 phase current	%	√	x	x
:	:	R	:				
:	:	R	:				
6920/8920	7960	R	HarI3[50] 50th harmonic of L3 phase current	%	√	x	x
6922/8922	7961	R	HarI3[51] 51st harmonic of L3 phase current	%	√	x	x
6924/8924	7962	R	Mean reactive power	var	√	√	√
6926/8926	7963	R	Mean reactive power max	var	√	√	√
6928/8928	7964	R	Mean reactive power min	var	√	√	√
6930/8930	7965	R	Mean active power factor (PF1+PF2+PF3)/3	-	√	x	√
6932/8932	7966	R	Mean active power factor min	-	√	x	√
6934/8934	7967	R	Mean active power factor max	-	√	x	√

In the 3-phase 3-wire (3Ph / 3W) respectively THD U12, THD U23, THD U31, THD U123

10 SOFTWARE UPGRADE

10.1 Firmware update - main program of the meter

A feature implemented in the ND30BAC meters enables to upgrade firmware using a PC with eCon software installed. Free eCon software and the update files are available at www.lumel.com.pl. Upgrade of meter software (firmware) can be done via RS-485 interface. Go to LUMEL UPDATER tab to upgrade.

a)

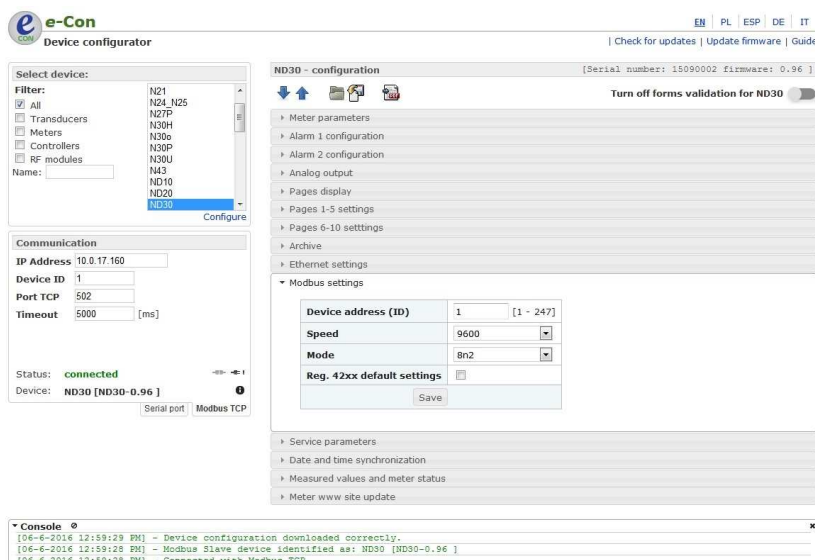

b)

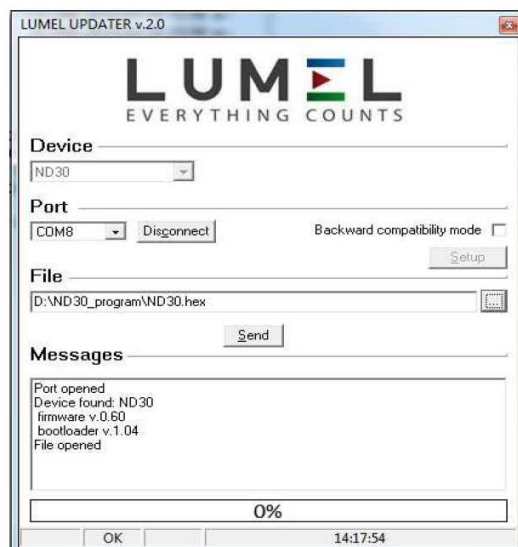



Fig. 25. Program window view: a) eCon, b) software upgrade



Note: Software update automatically resets meter settings to default settings, so it is recommended to save meter settings using eCon software before upgrading.

After launching eCon software, set in the settings required serial port, baud rate, mode and address of the meter. Next, select the ND30BAC meter and click *Config*. Click the down arrow icon to read all of the settings then the disk icon to save the settings to a file (required to restore the settings later). After selecting the option *Update firmware* (in the upper right corner of the screen) the window *Lumel Updater (LU)* will be opened – Fig. 25. Click *Connect*. The *Messages* information window displays information concerning upgrade process. If the port is opened correctly, a *Port opened* message appears. Upgrade mode is enabled using either of the two methods: remotely via LU (using eCon settings: address, mode, baud rate, COM port) and by turning a meter on while pressing the button  (while entering bootloader mode the button is used to set communication settings: baud rate 9600, RTU8N2, address 1). The display will show the bootloader version, while the LU program displays the message *Device found* and the name and version of the connected device. Click the "...” button and browse to the meter upgrade file. If the file is opened correctly, *File opened* message is displayed. Press the *Send* button. When upgrade is successfully completed, the meter begins normal work while the information window displays *Done* message and upgrade elapsed time. After the LU window is closed, go to parameter group *Service parameters*, select the option *Set default settings of a meter* and press a button *Restore*. Then press the folder icon to open a previously saved settings file and press the up arrow icon to save the settings in the meter. Current software version can be checked by reading the welcome message when switching the meter on.

Note: Turning meter supply off during upgrade process may result in permanent damage!

11 ERROR CODES

During the meter operation the error messages may be displayed. Following list shows reasons of errors.

- **Err bat** – displayed when the battery of the internal RTC clock is used up. Measurement is carried out after switching the supply on and every day at midnight. The message can be turned off by pressing the button . The disabled message remains inactive till the renewed switching of the meter on.
- **Err CAL, Err EE** – meter memory is damaged. In such case a meter should be sent back to the manufacturer.
- **Err PAr** – incorrect operational parameters of the meter. In such case a meter should be set to default settings (from menu or via RS-485 interface). The message can be turned off by pressing the button .
- $\wedge\wedge\wedge$ – upper overrun. Measuring value is out of the measuring range.
- $\vee\vee\vee$ – lower overrun. Measuring value is out of the measuring range.

12 TECHNICAL DATA

Measuring ranges and permissible basic errors

Table 22

Measuring value	Measuring range	L1	L2	L3	Σ	Class
Current I 1/5 A 1 A~ 5 A~	0.002 ..0.100..1.200 A 0.010 ..0.500.. 6.000 A ...100.00 kA (tr_I≠1)	•	•	•		0.2 (EN 61557-12)
Voltage U L-N: 57.7 V~ 110 V~ 230 V~ 400 V~	5.700..11.500 ..70.000 V 11.000..22.000 ..132.00 V 23.000..46.000 .. 276.00 V 40.000..80.000 .. 480.00 V ...1920.0 kV	•	•	•		0.2 (EN 61557-12)
Voltage U L-L: 100 V~ 190 V~ 400 V~ 690 V~	10.000 ..20.000..120.00 V 19.000 ..38.000..228.00 V 40.000..80.00 .. 480.00 V 69.000..138.00 .. 830.00 V ...1999.0 kV (tr_U≠1)	•	•	•		0.5 (EN 61557-12)
Active power P	-19999 MW .. 0.000 W19999 MW (tr_U≠1, tr_I≠1)	•	•	•	•	0.5 (EN 61557-12)
Reactive power Q	-19999 MVar .. 0.000 Var19999 MVar (tr_U≠1, tr_I≠1)	•	•	•	•	1 (EN 61557-12)
Apparent power S	0.000 .. 1999,9 VA19999 MVA (tr_U≠1, tr_I≠1)	•	•	•	•	0.5 (EN 61557-12)
Active energy EnP / import or export /	0.000 .. 99 999 999.999 kWh				•	0.5 ¹⁾ (EN 61557-12)
Reactive energy EnQ / capacity or inductive /	0.000 .. 99 999 999.999 kVarh				•	1 (EN 61557-12)
Apparent energy EnS	0.000 .. 99 999 999.999 kVAh				•	0.5 (EN 61557-12)
Active power factor PF	<u>-1.00 .. 0 .. 1.00</u>	•	•	•	•	1 (EN 61557-12)
Factor tg	<u>-1.20 .. 0 .. 1.20</u>	•	•	•	•	1
Frequency f	<u>45.000 ..65.000</u> Hz				•	0.1 (EN 61557-12)
Harmonic distortion factor of voltage THDU, current THDI	<u>0.0 .. 100.0%</u>	•	•	•	•	5 (EN 61557-12)
Harmonic amplitudes of voltage $U_{h2} \dots U_{h51}$, of current $I_{h2} \dots I_{h51}$	<u>0.0 .. 100.0%</u>	•	•	•		II (IEC61000-4-7)

tr_I - Current transformer ratio = Transformer primary current / Current transformer secondary current
tr_U - Voltage transformer ratio = Transformer primary voltage / Voltage transformer secondary voltage

¹⁾ Class 0.5 S acc. to EN 62053-22

Power consumption:	
- in supply circuit	≤ 6 VA
- in voltage circuit	≤ 0.5 VA
- in current circuit	≤ 0.1 VA
Readout field	3.5" TFT full-color screen, resolution: 320x240 pixel
Relay outputs (A1, A2)	2 programmable relays, volt-free NO contacts, load capacity (resistive) 0.5 A/250 V AC or 5 A/30 V DC Switching number: mechanical min. $5 \cdot 10^6$ electric min. 1×10^5
Serial interface RS-485	Modbus RTU 8N2, 8E1, 8O1, 8N1. Address 1..247, Baud rate 4.8, 9.6, 19.2, 38.4, 57.6, 115.2 kbit/s Maximum response time: 600 ms
Ethernet interface	10/100 Base-T, RJ45 socket, ICMP (Ping), BACnet IP ver. 1, rev. 12
Sampling	A/D Converter 16-bit sampling rate 6.4 kHz at 50 Hz 7.68 kHz at 60 Hz Simultaneous sampling of all loops, 128 samples per cycle
Harmonics	Harmonic (n) 1..51 Harmonic distortion factor referred to the voltage THD, current THD (n=2..51) 0.0 ..100.0% FFT analysis (Fast Fourier Transform)
Real Time Clock	±20 ppm, real time clock battery CR2032
Registration	Archiving period (registration interval) 1..3600 sec. Registration activation modes: n_on, noFF, on,oFF, H_on, HoFF, 3non, 3noF, 3_on, 3_oF, Registration time: depends on the configuration e.g. approx. 220 days for interval 1 sec. Files archive memory 8 GB
Terminals	
Cross section	0.05 .. 2.5 mm ²
Clamping screws	M3
Tightening torque	0.5 Nm
Protection grade ensured by the housing	
from the front	IP 65
from terminals side	IP 20
Weight	0.3 kg
Overall dimensions	96 x 96 x 77 mm
Reference and rated operating conditions	
- supply voltage	 85..253 V a.c. (40..50..400 Hz), 90..300 V d.c. or 20..40 V a.c., 20..60 V d.c.

- input signal:	0 .. $0.1..1.2I_n$; $0.1..0.2..1.2U_n$ for current, voltage, PF _i , tg;
	frequency 45 .. <u>50</u> .. <u>60</u> .. 65 Hz; sinusoidal (THD ≤ 8%)
- power factor	<u>-1...0...1</u>
- ambient temperature	-10.. <u>23</u> ..+55 °C, class K55 acc. to EN61557-12
- storage temperature	-20..+70 °C
- humidity	0 .. <u>40</u> .. <u>60</u> ..95% (no condensation)
- max. peak factor	
- current	2
- voltage	2
- external magnetic field	≤ <u>40</u> ...400 A/m DC ≤ 3 A/m AC 50/60 Hz
- short-term overload	
voltage inputs 5 sec.	2 Un
current inputs 1 sec.	50 A
- working position	any
- warm-up time	15 min.

Real time clock battery: CR2032

Additional errors:

in % of the base error

- from ambient temperature changes < 50% / 10 °C
- for THD > 8% < 50%

Standards fulfilled by the meter:

Electromagnetic compatibility:

- noise immunity in industrial environments acc. to EN 61000-6-2
radio-frequency common mode:
 - level 2: 0,15... 1 MHz
 - level 3: 1 MHz...80 MHz
- noise emission acc. to EN 61000-6-4

Safety requirements:

according to EN 61010-1 standard

- isolation between circuits: basic
- installation category III for voltage to earth up to 300 V
- installation category II for voltage to earth up to 600 V
- pollution grade 2,
- maximum phase-to-earth operating voltage:
 - for supply circuits and relay outputs 300 V
 - for measurement input 500 V
 - for circuits RS-485, Ethernet: 50 V
- altitude a.s.l. < 2000 m,

13 ORDERING CODE

ND30BAC network parameters meter ordering code.

Table 23

ND30BAC Meter-	X	X	X	X	XX	X	X
Input voltage (phase/phase-to-phase) Un 3x 57.7/100 V, 3x 230/400 V 3x 110/190 V, 3x 400/690 V	1 2						
Additional outputs/inputs 2 relays		1					
Interfaces BACnet IP and RS485 (Modbus RTU)			2				
Supply voltage: 85..253 V a.c., 90..300 V d.c. 20..40 V a.c., 20..60 V d.c.				1 2			
Version standard custom-made*					00 XX		
Language version Polish English other*						P E X	
Acceptance tests without extra requirements with quality inspection certificate acc. to customer's request*							0 1 X

* only after agreeing with a manufacturer

ORDERING CODE EXAMPLE, the code **ND30BAC-1 1 2 1 00 E 0** means:

- ND30BAC** – ND30BAC meter,
- 1** – input voltage 3 x 57.7/100 V, 3 x 230/400 V,
- 1** – 2 relays
- 2** – interface BACnet IP and RS485 (Modbus RTU)
- 1** – supply voltage: 85..253 V a.c., 90..300 V d.c.
- 00** – standard version
- E** – English language version
- 0** – without extra requirements.



LUMEL S.A.

ul. Sulechowska 1, 65-022 Zielona Góra, POLAND
tel.: +48 68 45 75 100, fax +48 68 45 75 508
www.lumel.com.pl,

Export department:

tel.: (+48 68) 45 75 139, 45 75 233, 45 75 321, 45 75 386
fax.: (+48 68) 32 54 091
e-mail: export@lumel.com.pl