

METER WITH A MULTICOLOURED
BARGRAPH

NA5PLUS

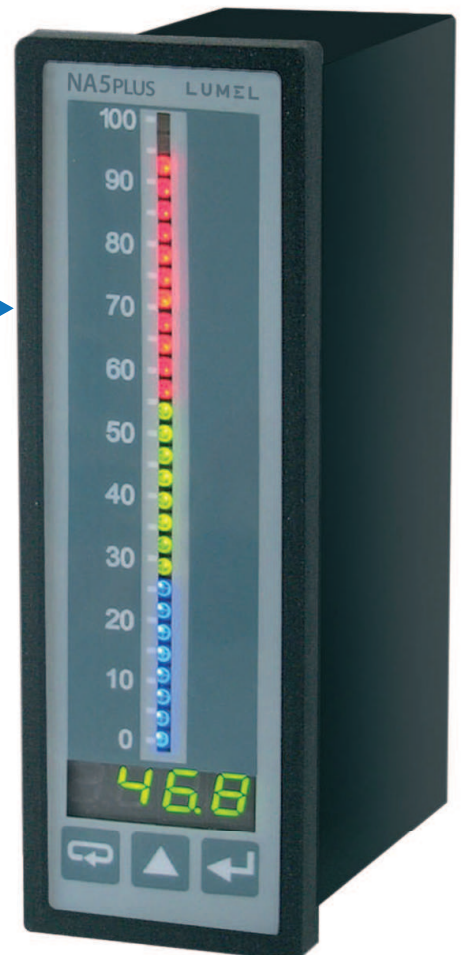

USER'S MANUAL



Contents

1. APPLICATION.....	3
2. NA5PLUS SET.....	3
3. BASIC REQUIREMENTS, OPERATIONAL SAFETY.....	4
4. INSTALLATION.....	5
4.1. Installation.....	5
4.2. External connections diagram.....	6
5. Operation.....	8
5.1 Changing meter parameters from the keyboard.....	10
6. RS-485 Interface.....	22
6.1. Serial interface connection method.....	22
6.2 MODBUS protocol.....	22
6.3 Description of the MODBUS protocol functions.....	22
6.4 Map of NA5Plus meter registers.....	24
6.5 Registers for recording and reading.....	25
6.6 Read-only registers.....	32
7. Meter configuration with E-Con software.....	33
8. METER PROGRAMMING EXAMPLES.....	34
9. BEFORE YOU REPORT A DEFECT.....	35
10. SOFTWARE UPDATE.....	37
11. TECHNICAL DATA.....	38
12. ORDERING CODES.....	41

1. APPLICATION

NA5Plus series meters with a bar graph have a universal input designed to measure temperature, resistance, voltage from shunts, standard signals, dc voltage and dc current. They can be used in various industries, such as: food industry, pumping stations and sewage treatment plants, chemical industry, weather stations, meteorological stations, breweries. They are intended for the visualisation of the measured quantity and evaluation of change trends of controlled technological processes. They can also be used in automation systems where programmed controllers are applied.

NA5Plus meters have, depending on the version, one or two continuous outputs (voltage or current), 4 relay outputs or 8 open collector (OC) type outputs, as well as an RS-485 interface. The meters are programmable via the keyboard and via RS-485.

NA5Plus meters perform the following functions:

- measurement of the input quantity and displaying it on the display and the bar graph,
- recalculations of the input signal into indication on the base of the individual multipoint characteristics,
- arithmetical functions: raising to a power, extraction of roots,
- programming of colours and bar graph resolutions,
- signalling of exceeding the set alarm values;
- recording of the measured signal in programmed time intervals,
- storage of maximum and minimum values,
- programming of the measurement averaging time,
- programming of the indication resolution,
- deadlock of the parameter introduction by means of a password,
- conversion of the measured quantity into a voltage or current output signal,
- RS-485 interface support in MODBUS RTU protocol.

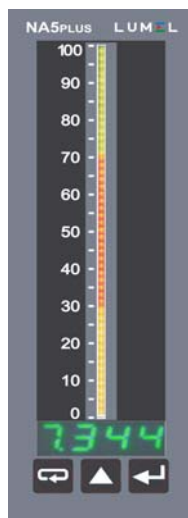

Fig. 1: View of NA5Plus meter.

2. NA5PLUS SET

The complete set of NA5Plus meter includes:

- NA5Plus Meter 1 pc
- user's manual 1 pc
- signal terminal strip (16 terminals) 2 pcs
- supply terminal strip (3 terminals) 1 pc
- holders to fix the meter in the panel 2 pcs

3. BASIC REQUIREMENTS, OPERATIONAL SAFETY

Meaning of the symbols used in this manual:

**Warning!**

Warning of potentially dangerous situations. It is especially important to read and understand these instructions before connecting the device. Failure to meet the instructions that are marked with this symbol can result in serious injury of personnel and damage to the device.

**Caution!**

Generally useful notes. Following these instructions ensures easy operation of the device. The user must take them into account when the operation of the device does not meet the user's expectations.

Possible consequences when these instructions are not followed!

In terms of operational safety, the meter meets the requirements of DIN EN 61010-1.

Safety instructions:

- The assembly and the installation of the electrical connections may be carried out only by a duly qualified electrician.
- The person performing the installation is responsible for the safety of the system in which devices is installed.
- Before turning on the module verify the connections.
- Removal of the meter housing during the warranty period voids the warranty. The module power supply must be turned off and the input circuits disconnected before opening the housing.
- The device is intended for installation and use in industrial electromagnetic environments.
- A switch or a circuit-breaker should be installed in the building or facility. It should be located near the device, easily accessible to the operator, and suitably marked.
- In the event of damage, the meter can be repaired only by the service authorized by the manufacturer.
- Before using the repaired meter make sure that it is working properly.
- Connection of the meter and/or its usage inconsistently with this manual can reduce the operational safety of the meter.

4. INSTALLATION

4.1. Installation

The NA5Plus meter is designed to be mounted on a panel. For this purpose, a 44.0 x 137.5 mm hole should be prepared in the panel. The thickness of the material from which the panel was made should be in the 1.45 mm range.

In the back of the meter housing there are detachable terminal strips, enabling connection of power supply, input signals, output signals and RS482 interface with wires with a cross-section of up to 2.5 mm². The dimensions of the meter are shown in Fig. 2.

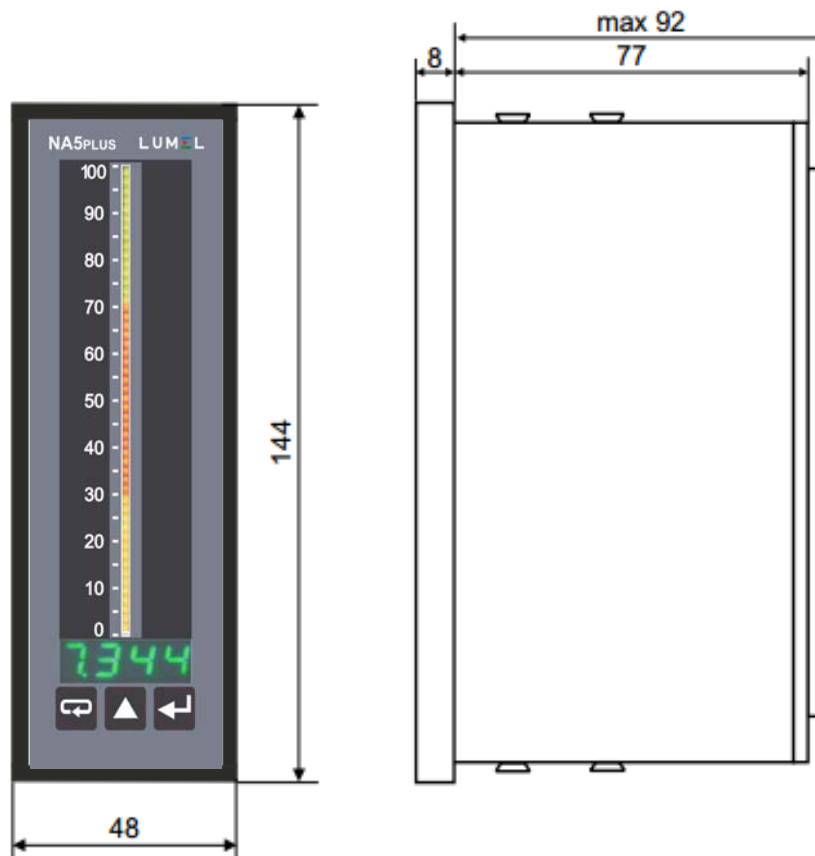

Fig. 2: Dimensions of the meter

4.2. External connections diagram

The connections of the meter are shown in Figure 3. In the event when the meter is powered with DC voltage, the voltage polarity does not matter.

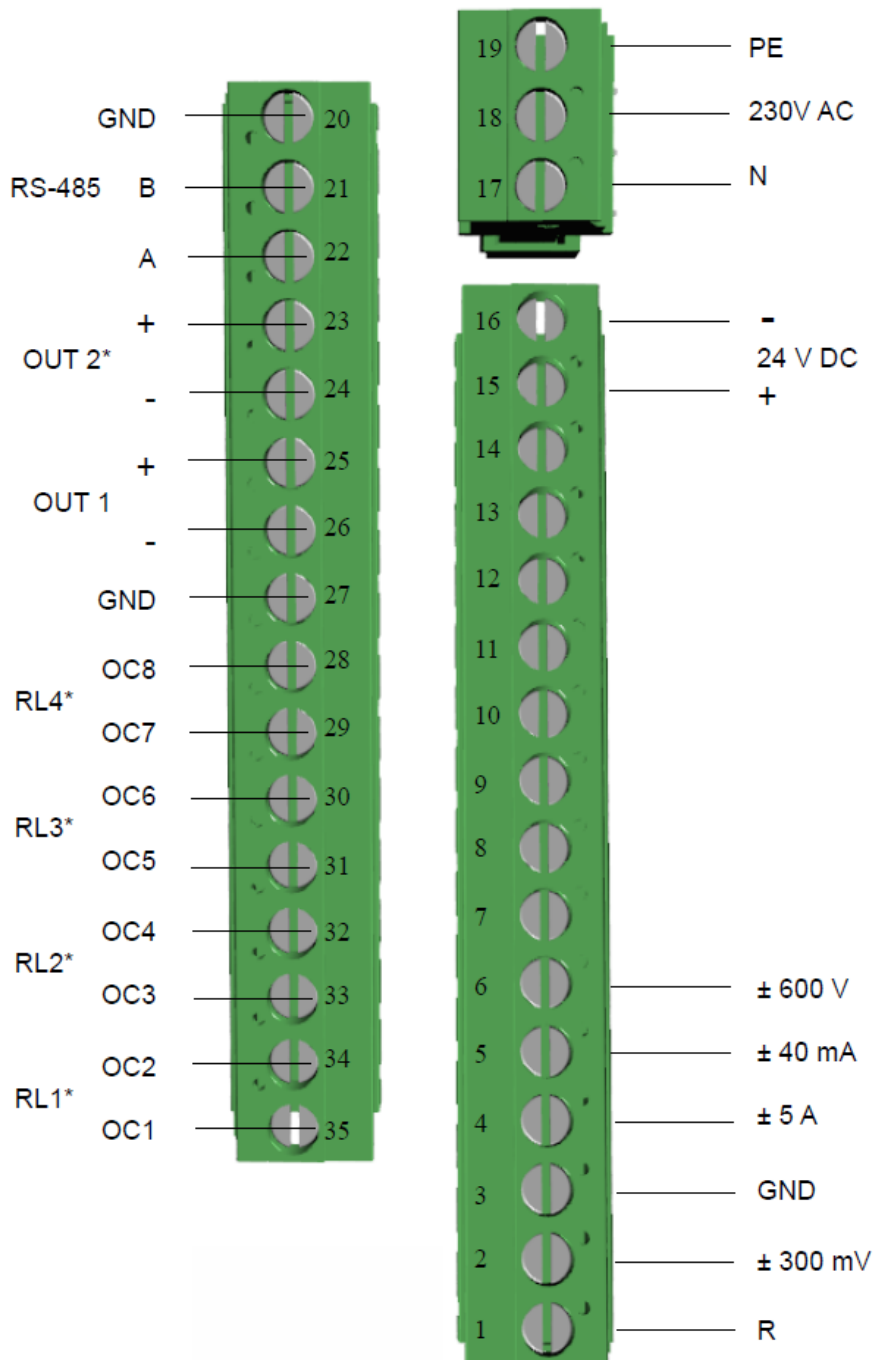

Fig. 3: Electrical connections of NA5Plus meter

*) optional elements, depending on the meter's version

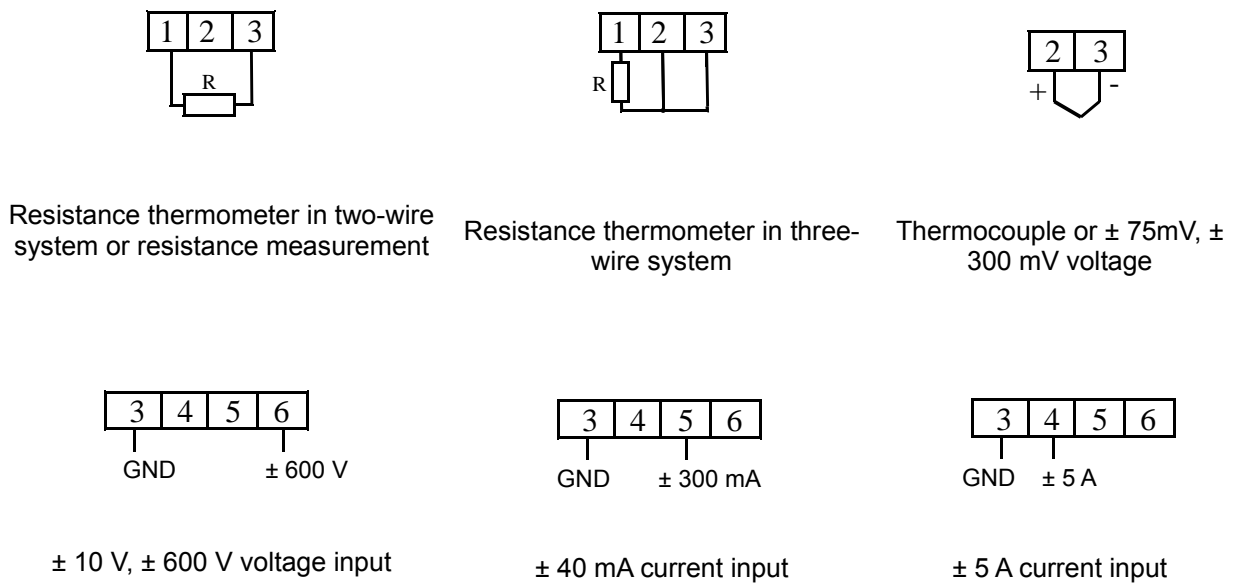

Fig. 4: Input signals connection method

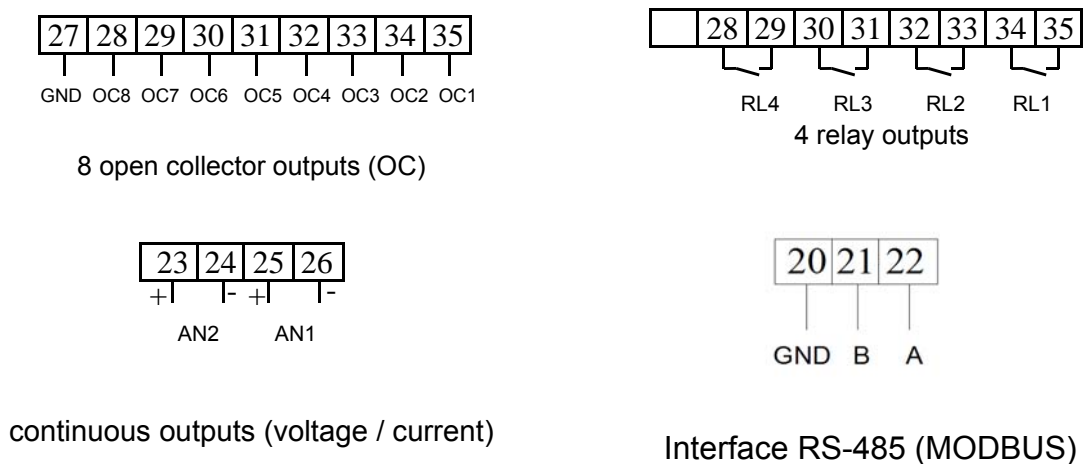

Fig. 5: Output signals connection method

depending on the version

Taking into consideration electromagnetic interference it is recommended to use shielded conductors for the connection of input and output signals. The power supply must be connected by means of a two-wire conductor with a suitable cross-section ensuring its protection by means of an installation fusible cut-out, in case of a short-circuit. The requirements concerning the supply cable are regulated by EN 61010-1 p.6.10 standard.

5. Operation

After connecting external signals and switching on the power supply, the meter displays the type and current version of the meter program.

After ca 3 seconds, the meter switches automatically to the operating mode in which it carries out measurements and displays the measured value on the display and the bar graph. Depending on alarm parameters settings, the resolution and bar graph type, alarm thresholds are also displayed on the bar graph. The meter blanks automatically insignificant zeros.

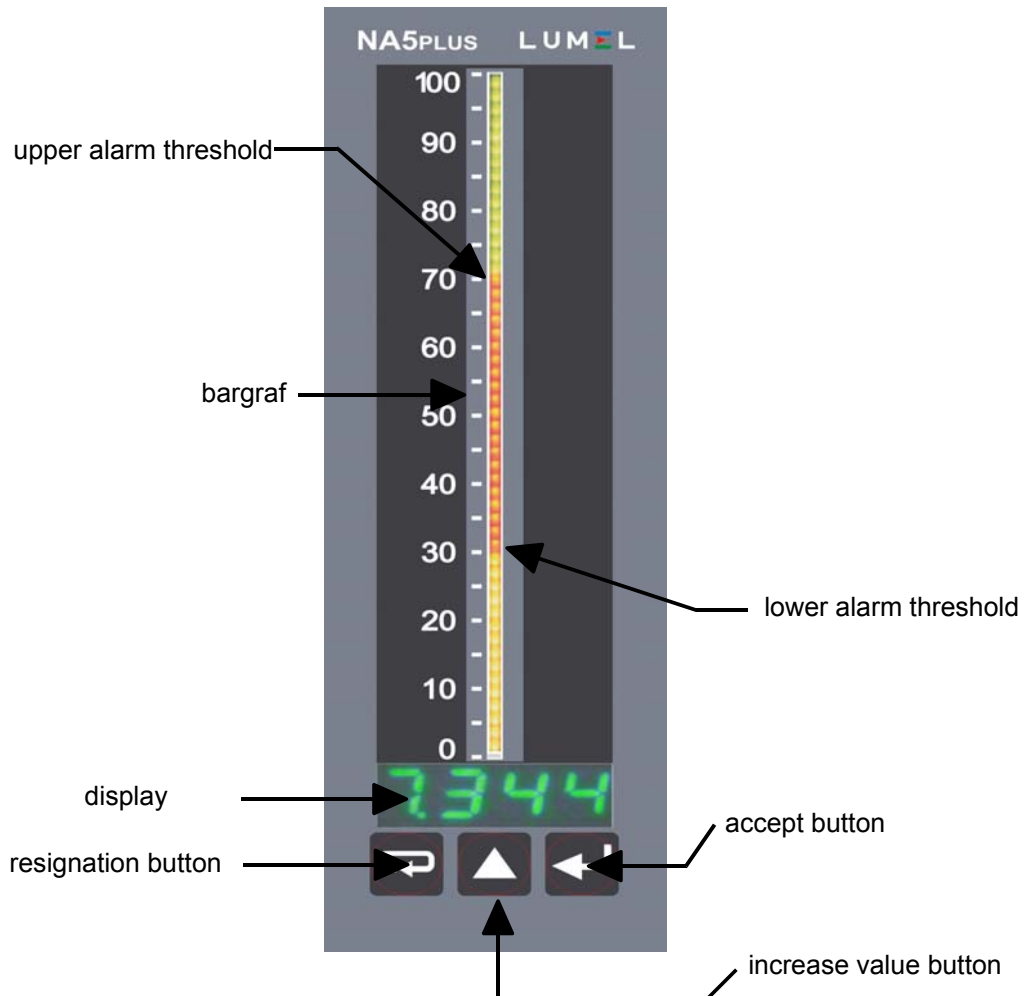

Fig. 6: Description of the front panel of the NA5Plus meter

Functions of the keys:



accept button

- entering the programming mode (hold this key for about 3 seconds).
- entering the chosen parameter level,
- entering the parameter value changing mode
- accepting the changed parameter value.



**value increase key**





- displaying the minimum and maximum values successively for subsequent measurement channels
- navigating the preview menu or programming matrix
- changing the value of the selected parameter - increasing the value

**cancel key**

- entering the menu of registered results
- entering the parameter preview menu (hold for about 3 seconds)
- exit from the preview menu or programming matrix
- resignation from the parameter change

Pressing and holding the  key for about 3 seconds causes entering the programming mode. The programming mode is secured with the **555** security code.

Pressing and holding the  key for about 3 seconds causes entering the menu of the preview and the menu of recorded values. Navigating the preview menu is done using the  key. In this menu, all programmable parameters of the meter are available for read-out, with the exception of service parameters. The exit from the preview menu is done by means of the  key.

An overview of the recorded values is possible after pressing the  key on the **RESL** parameter in the preview menu. The recorded result number is displayed alternately with the value e.g. **320/2 174**. Navigating the recorded values is done using the  key. Holding this key for longer than about 2 seconds will speed up the browsing. Pressing the  key at any time will display the number of recorded results. The exit from the viewing recorded values is done by pressing the  key.

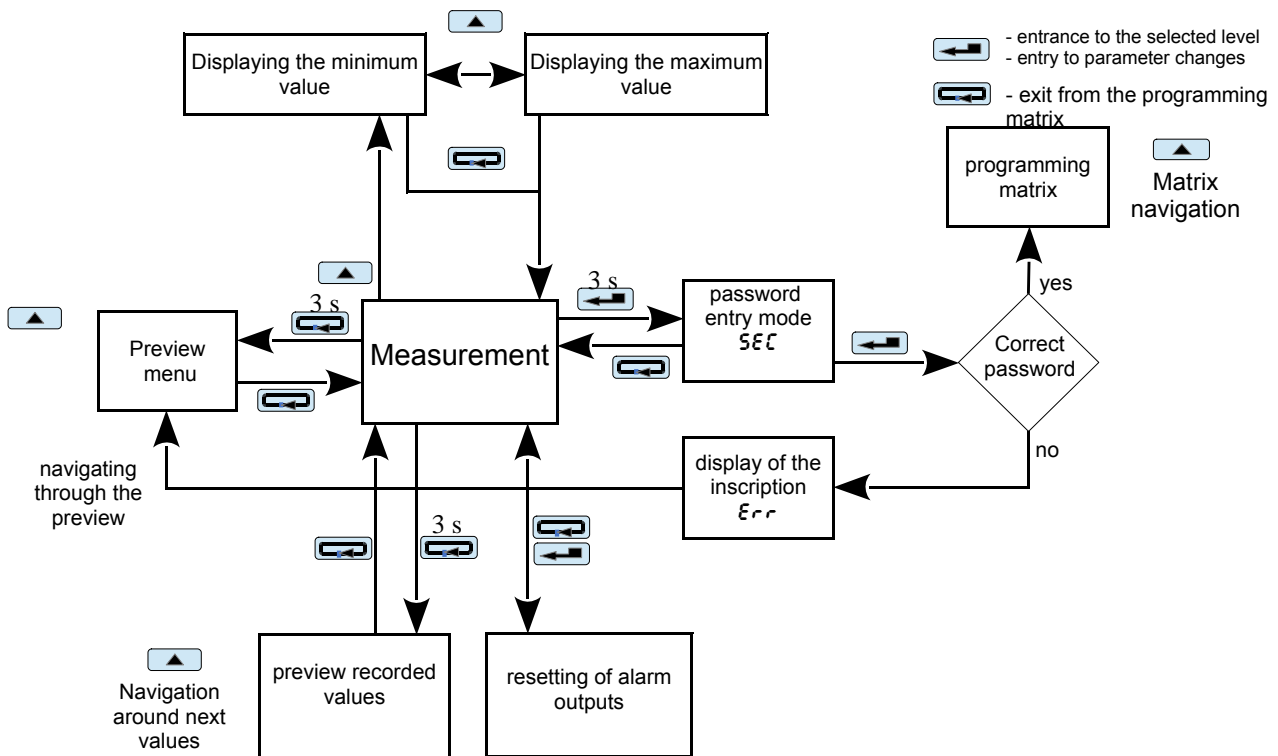

Fig. 7 The NA5Plus meter operation algorithm

Displaying the following symbols and inscriptions on the display means:

	incorrectly entered security code
	upper measuring range exceeded or no sensor
	lower measuring range exceeded or no sensor
	error of the conductor resistance compensation. Conductor not connected or damaged

5.1 Changing meter parameters from the keyboard

Pressing the key for approx. 3 s causes the display of the SEC message alternately with the factory-set value of 0. Entering the correct code results in entering the programming mode. Figure 8 shows the transition matrix in the programming mode. The key allows for moving around the main parameters groups, e.g.: Ch1, bAr1, AL1, AL2, etc.

Pressing the key on the given level, causes the entry into parameters of this level. Moving around a given level takes place by means of the key. To change the value, use the key. To cancel the parameter change, press the key. The same key is used to exit the selected level and programming matrix to the measurement.

The transitions matrix in the programming mode is shown in Figure 9.

During operation of the meter in the programming mode, the measurement result is displayed on the bar graph, except for selecting the display test function.

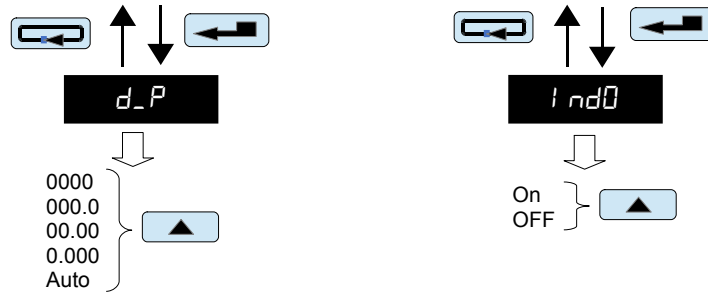

Examples of changing the value of the selected parameter (parameter - symbol)

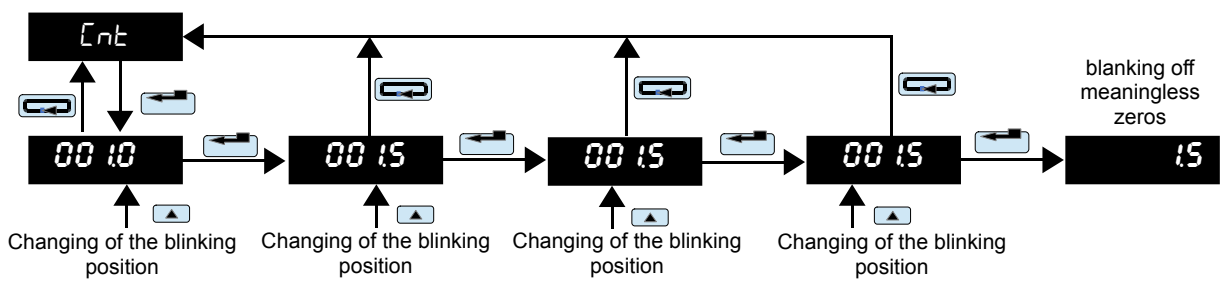

Example of changing the value of the selected parameter with a fixed decimal point (numeric parameter)

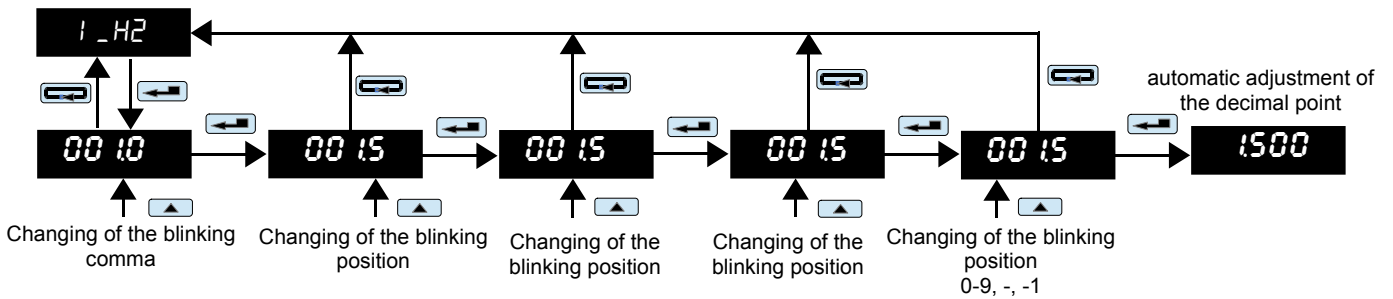

Example of changing the value of the selected parameter with a variable decimal point (numeric parameter)

Fig. 8 Examples of changes in parameter values

Main menu	Parameters of the selected level														
<i>Ch1</i>	<i>TYPE</i> Input type	<i>unit</i> temperature unit °C/F	<i>Loln</i> lower value of the input range	<i>Hiln</i> upper value of the input range	<i>Func</i> mathematical functions	<i>Con</i> type of compensation	<i>d_P</i> decimal point	<i>Cnt</i> measurement time	<i>Indl</i> individual input characteristics	<i>PtS</i> number of points of Individual characteristics	<i>IHD1</i> parameter 1 of individual characteristics	<i>dY1</i> parameter 1 of individual characteristics	...	<i>IHD21</i> parameter 21 of individual characteristics	<i>dY21</i> parameter 21 of individual characteristics
<i>bAr1</i>	<i>TYPEb</i> bar graph type	<i>color</i> bar graph colour	<i>brL</i> lower threshold of bar graph indication	<i>brH</i> upper threshold of bar graph indication											
<i>AL1</i> --- <i>ALB</i>	<i>PrL</i> lower alarm threshold	<i>PrH</i> upper alarm threshold	<i>TYPEA</i> alarm type	<i>dLY</i> alarm delay	<i>HOLD</i> holding up the alarm	<i>CUrL</i> colour of the lower alarm marker	<i>CUrH</i> colour of the upper alarm marker	<i>dErE</i> Value of change in the measured signal	<i>d_t</i> time of change in the measured signal						
<i>Out1</i> --- <i>Out2</i>	<i>IndO</i> output individual characteristics	<i>d_H1</i> parameter of individual characteristics	<i>O_Y1</i> parameter of individual characteristics	<i>d_H2</i> parameter of individual characteristics	<i>O_Y2</i> parameter of individual characteristics										
<i>URrE</i>	<i>bAud</i> baud rate	<i>modE</i> method of transmission	<i>Addr</i> device address												



<i>SEr</i>	<i>tSt</i> display and bar graph test	<i>Hour</i> time setting	<i>SECU</i> setting the settings access code	<i>CLrL</i> erasing the minimum values	<i>CLrH</i> erasing the maximum values	<i>dFLt</i> factory settings
<i>LOGr</i>	<i>rEC</i> recording	<i>Hr_1</i> recording start	<i>dA_1</i> recording date	<i>Int_1</i> recording interval		

Figure 9 Transition matrix in programming mode.

Programmable parameters of the NA5Plus meter

	Symbol on the display	Parameter description	Scope of changes
Input parameters [h1]	TYP	Input type	resistance thermometer Pt 100 Pt 500 Pt 1000 thermocouples: J thermocouple K thermocouple N thermocouple E thermocouple R thermocouple S thermocouple T thermocouple resistance up to 10 kΩ voltage up to ± 75 mV voltage up to ± 300 mV voltage up to ± 10 V voltage up to ± 600 V current up to ± 40 mA current up to ± 5 A
	unit	Unit of thermometric quantity Possibility to select the unit in which the temperature measurement result is displayed (°C/°F)	.C : Celsius degrees .F – Fahrenheit degrees
	LoIn	Lower value of the input range Setting the LoIn and HiIn parameters gives the possibility of narrowing the measurement range	Possible settings: -1999...9999 At the input signal <LoIn the meter will display the lower range exceeding. The LoIn <HiIn condition must be met. The parameter does not take into account the individual characteristics it works on the measured signal only.
	HiIn	Upper value of the input range	Possible settings: -1999...9999 At the input signal <HiIn the meter will display the upper range exceeding. The LoIn <HiIn condition must be met. The parameter does not take into account the individual characteristics it works on the measured signal only.
	FUNC	Mathematical functions performed on channels	OFF - mathematical functions are turned off 59r – exponentiation (result) ² 59r√ – square root \sqrt{result}
	COFF	Type of compensation for changes in the sensor working conditions - in the case of a resistance thermometer and resistance measurement, it applies to the compensation of changes in the resistance of wires connecting the sensor with the meter - in the case of a thermocouple, it applies to the compensation of temperature changes of the reference joints	Avto - automatic compensation (in the case of resistance thermometers and resistance measurement it requires a three-wire line) 0,0...60,0 °C – reference temperature value for thermocouples 0,0...40,0 Ω – resistance of two wires for resistance thermometers and resistance measurements Entering values outside the manual compensation range (e.g. 70.0) will cause switching on automatic compensation .
	d.P	Decimal point setting The setting works both with the individual characteristics switched off and switched on. Entering a decimal point which makes displaying four characters on the display impossible results in displaying the lower or upper exceeding.	Possible settings: 0000 0000 0000 0000 Auto – automatic selection of decimal point
	TIME	Averaging time of the measurement	0,0...999.9 s Entering 0 causes the measurement to be turned off and the meter to stop working. The meter displays the time in this state. The bar graph is blank.

	<i>indl</i>	Turning off or on individual characteristics	<p><i>On</i> – characteristics on</p> <p><i>OFF</i> – characteristics off</p>
	<i>PtS</i>	<p>Number of points of Individual characteristics</p> <p>Determining the number of points for a multi-point individual characteristics.</p>	<p>Possible settings: 2...21</p> <p>Entering a value smaller than 2 sets the number of points to the minimum value (2), entering a value greater than 21 sets the number of points to the maximum value (21).</p>
	<p><i>IH01</i></p> <p><i>dY01</i></p> <p>...</p> <p><i>IH21</i></p> <p><i>dY21</i></p>	<p>Parameters of individual characteristics</p> <p>The number of points used to shape the individual characteristics is determined by the PtS parameter. Based on the coordinates of successive points given by the user, the meter determines (from the system of equations) the individual characteristics coefficients a and b for the sections connecting successive points of the characteristics.</p> $\begin{cases} dY01 = a_1 \cdot IH01 + b_1 \\ dY02 = a_1 \cdot IH02 + b_1 \\ dY03 = a_2 \cdot IH03 + b_2 \\ \dots \\ dY20 = a_{20} \cdot IH20 + b_{20} \\ dY21 = a_{20} \cdot IH21 + b_{20} \end{cases}$ <p>where: IH01...IH21 – measured values dY01...dY21 – expected values</p>	<p>Possible settings: -1999...9999</p>
Bar graph parameters <i>bar-1</i>	<i>typb</i>	Bar graph type	<p><i>oneC</i> - one-colour bar graph</p> <p><i>sect</i> - sectional bar graph</p> <p><i>SEct</i> - segmented bar graph</p> <p><i>Plnt</i> - point bar graph</p> <p><i>trEn</i> - trend bar graph</p>
	<i>colr</i>	Bar graph colour	<p><i>OFF</i> - bar graph off</p> <p><i>r</i> - red</p> <p><i>g</i> - green</p> <p><i>rg</i> - red + green</p> <p>Other colours available only in meters with a seven-colour bar graph</p> <p><i>b</i> - blue</p> <p><i>rb</i> - red + blue</p> <p><i>gb</i> - green + blue</p> <p><i>rgb</i> - red + green + blue</p>
	<i>brL</i>	<p>Lower threshold of bar graph indication</p> <p>Parameter for setting the "magnifying glass" on the bar graph. The value on the display at which the bar graph is to be blanked.</p>	<p>Possible settings: -1999...9999</p>
	<i>brH</i>	<p>Upper threshold of bar graph indication</p> <p>Parameter for setting the "magnifying glass" on the bar graph. The value on the display at which the bar graph is to be fully illuminated.</p>	<p>Possible settings: -1999...9999</p>

Alarm parameters AL 1 ... ALB	<i>P_{rL}</i>	Lower alarm threshold	Possible settings: -1999...9999
	<i>P_{rH}</i>	Upper alarm threshold	Possible settings: -1999...9999
	<i>TYPA</i>	Alarm type	<i>n_on</i> – normal on <i>n_of</i> – normal off <i>On</i> - switched on <i>OFF</i> - switched off <i>H_On</i> – manually switched on; until the alarm type is changed, the alarm output is permanently switched on <i>H_of</i> – manually switched off; until the alarm type is changed, the alarm output is permanently switched off <i>dELt</i> – reaction to the slope
	<i>dLY</i>	Alarm delay The parameter is defined in seconds. Defines the time to elapse from the time of alarm occurrence to the time when alarm output is triggered. The alarm is activated after averaging the measurement. The alarm is switched off without delay.	Possible settings: 0.0...999.9 s Entering 0.0 causes the alarm to be activated when it occurs.
	<i>HOLD</i>	Holding up alarm signalling When the function is switched on, after the alarm state has disappeared, the alarm remains activated (relay contacts or OC output). SThe alarm state is active until it  is erased by the combination of  and  keys.	<i>OFF</i> - alarm output hold up is disabled <i>On</i> - alarm output hold up is enabled
	<i>CurL</i>	The colour of the lower alarm threshold marker	<i>OFF</i> - bar graph off
	<i>CurH</i>	The colour of the upper alarm threshold marker	<i>r</i> - red <i>G</i> - green <i>rG</i> - red + green Other colours available only in meters with a seven-colour bar graph <i>b</i> - blue <i>rb</i> - red + blue <i>Gb</i> - green + blue <i>rGb</i> - red + green + blue
	<i>dErt</i>	Value of change in the measured signal The change value of the signal measured at the time specified in parameter <i>D_t</i> . After exceeding the set threshold, the alarm is activated (relay contacts or OC output). Exceeding the threshold value increase in time is signalled by an intermittent message of the length of 1s on the display. ALX ⁺ - Where x is the alarm number. Occurs in the case of a measured signal increase. ALX ₋ - Where x is the alarm number. Occurs when the measured signal decreases. When the alarm stops, the message disappears.	Possible settings: -1999...9999 Entering positive values causes the alarm to be activated if the rate of change of the measured signal in the indicated time increases above the entered value <i>dErt</i> (the alarm reacts to the speed of the increase of the measured signal) Entering negative values causes the alarm to be activated if the rate of change of the measured signal in the indicated time decreases above the entered value <i>dErt</i> (the alarm reacts to the speed of the decrease of the measured signal) Entering the value 0 deactivates the <i>dELt</i> alarm function
	<i>d_t</i>	time of change in the measured signal	Possible settings: 0...3600 sec. Entering the value 0 deactivates the <i>dELt</i> alarm function

Output parameters <i>Out 1 / Out 2</i>	<i>Ind0</i>	Turning off or on individual characteristics	<i>On</i> – characteristics on <i>OFF</i> – characteristics off With the characteristics turned off, the meter operates with a maximum range depending on <i>LoIn</i> and <i>HiIn</i> input range
	<i>d_H1</i>	Parameters of the individual output characteristics Based on the coordinates of two points given by the user, the meter determines (from the system of equations) the individual characteristics coefficients <i>a</i> and <i>b</i> . $\begin{cases} O_Y1 = a \cdot d_H1 + b \\ O_Y2 = a \cdot d_H2 + b \end{cases}$ where: <i>d_H1</i> , <i>d_H2</i> – displayed values <i>O_Y1</i> , <i>O_Y2</i> – expected values on the output	Possible settings: -1999...9999
	<i>O_Y1</i>		
	<i>d_H2</i>		
	<i>O_Y2</i>		
Parameters <i>UART</i>	<i>bAud</i>	RS-485 interface baud rate	<i>24</i> – 2400 b/s <i>48</i> – 4800 b/s <i>96</i> – 9600 b/s <i>192</i> – 19200 b/s <i>576</i> – 57600 b/s <i>1152</i> – 115200 b/s
	<i>modE</i>	Transmission method via RS-485 interface	<i>OFF</i> – interface off <i>r8n2</i> – RTU 8N2 <i>r8E1</i> – RTU 8E1 <i>r8o1</i> – RTU 8O1 <i>r8n1</i> – RTU 8N1
	<i>Addr</i>	Device address for MODBUS protocol	Possible settings: 1...247
Service parameters <i>SEr</i>	<i>tSt</i>	Display and bar graph test The test consists in displaying the numbers 1111, 2222, etc. on the displays. Subsequent points are lit on bar graphs in the available colours. The test continues until it is turned off.	<i>n0</i> – disabling the test <i>YES</i> – enabling the test After activating, the test will start after exiting the menu.
	<i>Hour</i>	Setting the current time Time format: hh.mm The clock is reset after a voltage failure	Possible settings: 00.00 ... 23.59
	<i>SECU</i>	Entering the password	Possible settings: -1999... 9999 Setting the value to 0 disables the entry protection for the menu.
	<i>CLrL</i>	Erasing the minimum values	<i>n0</i> – do not erase <i>YES</i> – erasing the minimum values
	<i>CLrH</i>	Erasing the maximum values	<i>n0</i> – do not erase <i>YES</i> – erasing the maximum values
	<i>dFLt</i>	Factory parameters Restoring factory parameters of the meter.	<i>n0</i> – do nothing <i>YES</i> – restore factory parameters

LOG recording parameters	<i>rEC</i>	Enabling or disabling recording At the moment recording is enabled, the meter deletes the previous stored channel values.	<i>OFF</i> – recording off <i>rEC 1</i> – channel 1 recording on
	<i>Hr_1</i>	Recording start time Time format: hh.mm.ss	Possible settings: 00.00.00 ... 23.59.59
	<i>dR_1</i>	Recording start date Date format: yy.mm.dd	Possible settings: 00.01.01 ... 99.12.31
	<i>int_1</i>	Time interval of recording Specifies the time segment after which the result is to be saved. The minimum interval is 1 second. Time format: hh.mm.ss	Possible settings: 00.00.01 ... 24.00.00

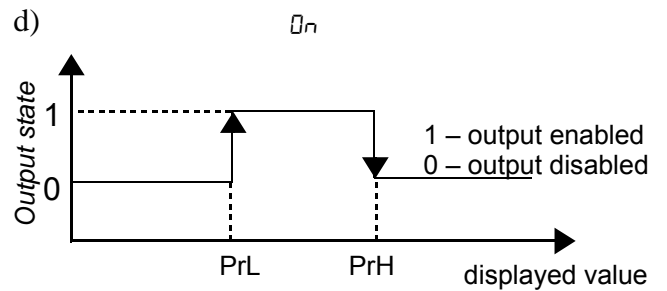
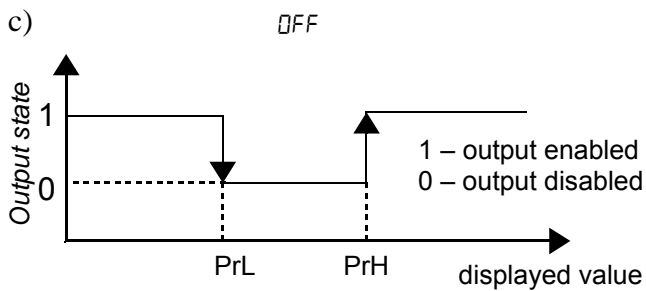
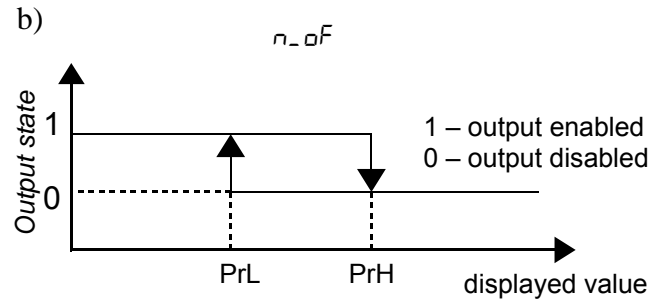
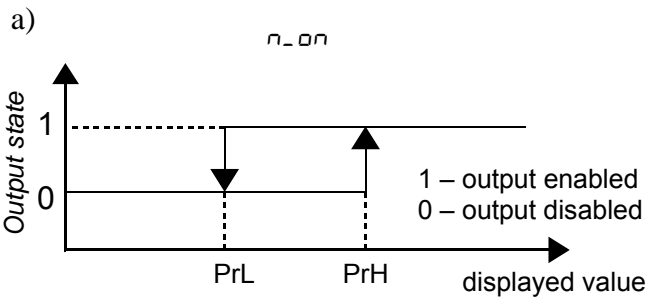

Bar graph type	Examples of bar graph and alarm settings, e.g. 1 $c_{oLr} = <$ (green) $c_{uLr} = r$ (red) $c_{uHr} = r <$ (red + green)	Remarks
<i>OnEC</i>		
<i>intr</i>		measurement < P_{rL}
		$P_{rL} <$ measurement < P_{rH}
		measurement > P_{rH}
<i>SEct</i>		
<i>PInt</i>		
<i>trEn</i>		the value does not change over time
		the value increases
		the value decreases

Fig. 12 Bar graph operation modes

Caution!



- the meter operates within the measurement range defined by the user in the L_{oIn} and H_{iIn} parameters. Outside the defined range, the meter signals exceeding the range.
- in the case of a meter with a resistance thermometer in a two-wire system, the choice of the option of automatic compensation of changes in the resistance of the wires will result in faulty operation of the meter and displaying the E_{rrE} message.
- when individual display characteristics are switched on, the result is converted according to the sectional characteristics in accordance with the introduced parameters $I_{H01} \dots I_{H21}$ and $d_{Y01} \dots d_{Y21}$.
- when arithmetic functions and individual characteristics are switched on, the arithmetic operations are performed first and the result obtained is transformed by individual characteristics.
- when the individual characteristics for the analog output is switched on, the displayed value is linearly transformed according to the entered d_{H1} , d_{H2} and O_{Y1} , O_{Y2} parameters.
- the meter regularly controls the values of the entered parameter. If the entered value exceeds the upper or lower range of changes, the meter will not record the parameter.
- if the input type is changed, the decimal point is changed at the same time, optimally for the given input.
- after a power failure, the current time is reset.
- recording is switched off when:
 - it was disabled from the meter menu level
 - the input type was changed
 - the recording start time was changed
 - the recording interval was changed
 - setting the averaging time for the c_{nt} measurement to 0
 - memory full
 - power on the meter

- on a bar graph working in *Int* or *SEct* mode, it is possible to set only one *[UrL]* and *[UrH]* alarm markers (from one alarm). Setting markers for the selected alarm activates them on the bar graph and automatically disables the markers from other alarms assigned to the same measurement channel.
- the max and min values are erased in case of change of
 - Input type
 - individual characteristics (on, off)
 - restoring factory parameters

Parameter description	Factory parameter	Parameter description	Factory parameter
<i>tYP</i>	<i>nnAL</i>	<i>HOLD</i>	<i>oFF</i>
<i>Unit</i>	<i>.C</i>	<i>[UrL]</i>	<i>r</i>
<i>LoL n</i>	<i>- 1999</i>	<i>[UrH]</i>	<i>rG</i>
<i>HiL n</i>	<i>9999</i>	<i>dEr t</i>	<i>00</i>
<i>Func</i>	<i>oFF</i>	<i>d_t</i>	<i>0</i>
<i>[on]</i>	<i>00</i>	<i>Ind0</i>	<i>oFF</i>
<i>d_P</i>	<i>Auto</i>	<i>d_H1</i>	<i>00</i>
<i>[nt]</i>	<i>10</i>	<i>0_Y1</i>	<i>00</i>
<i>Ind1</i>	<i>oFF</i>	<i>d_H2</i>	<i>00</i>
<i>PtS</i>	<i>2</i>	<i>0_Y2</i>	<i>00</i>
<i>1 HD 1</i>	<i>00</i>	<i>bAud</i>	<i>115.2</i>
<i>dY0 1</i>	<i>00</i>	<i>nodE</i>	<i>rBn 1</i>
...	...	<i>Addr</i>	<i>1</i>
<i>HH2 1</i>	<i>00</i>	<i>tSt</i>	<i>n0</i>
<i>dY2 1</i>	<i>00</i>	<i>HoUr</i>	<i>0000</i>
<i>tYPb</i>	<i>SEct</i>	<i>SECU</i>	<i>0</i>
<i>coLr</i>	<i>oFF</i>	<i>[LrL]</i>	<i>n0</i>
<i>brL</i>	<i>- 1999</i>	<i>[LrH]</i>	<i>n0</i>
<i>brH</i>	<i>9999</i>	<i>dFLt</i>	<i>n0</i>
<i>PrL</i>	<i>- 1999</i>	<i>rEC</i>	<i>oFF</i>
<i>PrH</i>	<i>9999</i>	<i>Hr_ 1</i>	<i>240000</i>
<i>tYPA</i>	<i>n_on</i>	<i>dA_ 1</i>	<i>15.0 10 1</i>
<i>dLY</i>	<i>00</i>	<i>Int 1</i>	<i>15.00</i>

CAUTION: Restoration of factory parameters is possible by holding down all the keys when the power is turned on and holding them down for about 2 seconds, and then releasing them.

6. RS-485 Interface

The digital programmable NA5Plus meters have a serial link in the RS-485 standard for communication in computer systems and with other devices that perform the Master function. The MODBUS communication protocol has been implemented on the serial link. The data transmission protocol describes methods of information exchange between the devices through the serial link.

6.1. Serial interface connection method

The RS-485 interface allows direct connection of up to 32 devices on a single link of the length of up to 1,200 m. To connect more devices, it is necessary to use additional intermediary-separating systems.

Interface line outputs are shown in Fig. 3 of this manual. To obtain correct transmission it is necessary to connect lines A and B in parallel with their equivalents in other devices. The connection must be made with a shielded conductor and the shield must be connected to the protective terminal at a single point. The GND line is used for additional protection of the interface line for long connections. GND signals should be connected between the devices and at one point to the protective terminal (this is not necessary for correct operation of the interface).

To obtain a connection with a PC, a converter from available computer interfaces to RS-485 is necessary, e.g. RS-232 to RS-485 (PD5 from LUMEL SA), USB to RS-485 (PD10 from LUMEL SA) or a dedicated RS-485 interface card installed in the computer.

The marking of transmission lines for the card in the PC depends on the card manufacturer and should be included in the instruction manual of the card.

6.2 MODBUS protocol

List of serial link parameters for the MODBUS protocol:

- address of the meter 1...247
- baud rate 2400, 4800, 9600, 19200, 57600, 115200 bit/s
- operating mode RTU 8N1, RTU 8N2, RTU 8E1, RTU 8O1
- maximum response time 500 ms

The configuration of the serial link parameters consists in determining the baud rate ($bRud$), device address ($Raddr$), and operating mode ($modE$).

Caution: Each meter connected to the communication network must:

- have a unique address
- the same baud rate and operating mode

6.3 Description of the MODBUS protocol functions

The following functions of the MODBUS protocol have been implemented in the NA5Plus meters:

Code	Meaning
03 (03 h)	readout of n-registers
06 (06 h)	recording of a single register
16 (10 h)	recording of n-registers
17 (11 h)	slave device identification

Readout of n-registers (code 03h)

This function is not available in the publication mode.

Example. Readout of 2 registers, starting with the register addressed 1DBD (7613)

Request:

Device address	Function	Register address Hi	Register address Lo	Number of registers Hi	Number of registers Lo	Checksum CRC
01	03	1D	BD	00	02	52 43

Response:

Device address	Function	Number of bytes	Value from register 1DBD (7613)				Value from register 1DBE (7614)				Checksum CRC
01	03	08	00	00	00	00	00	00	00	00	95 D7

Record of values into the register (code 06h)

This function is available in the publication mode.

Example. record of the register addressed 1DBDh (7613)

Request:

Device address	Function	Register address Hi	Register address Lo	Value from register 1DBD h (7613)				Checksum CRC
01	06	1D	BD	3F	80	00	00	85 AD

Response:

Device address	Function	Register address Hi	Register address Lo	Value from register 1DBD h (7613)				Checksum CRC
01	06	1D	BD	3F	80	00	00	85 AD

Record into n-registers (code 10h)

This function is available in the publication mode.

Example. Recording 2 registers, starting from the register addressed 1DBD h (7613)

Request:

Device address	Function	Register address		Number of registers		Number of bytes	Value from register 1DBD h (7613)				Value from register 1DBE h (7614)				Checksum CRC
		Hi	Lo	Hi	Lo										
01	10	1D	BD	00	02	08	3F	80	00	00	40	00	00	00	03 09

Response:

Device address	Function	Register address Hi	Register address Lo	Number of registers Hi	Number of registers Lo	Checksum CRC
01	10	1D	BD	00	02	D7 80

Device identification (code 11 h)

Example. Readout of data identifying a device for NA5Plus meter

Request:

Device address	Function	Checksum CRC
01	11	C0 2C

Response:

Device address	Function	Number of bytes	Device ID	State of the device	Field depending on device type	Checksum CRC
01	11	19	E1	FF	xxxxxxxxxxx	

Device address - depending on the setpoint
 Function - function no. (11 h)
 Number of bytes - 19 h
 Device ID - E1 h
 Device state - FF h
 Field depending on device type - device name
 - software version

6.4 Map of NA5Plus meter registers

Address range	Value type	Description
7000	float (32 bits)	Value is placed in two successive 16-bit registers. Registers contain the same data as 32-bit registers of 7500 range. Registers are read-only.
7100	float (32 bits)	Value is placed in two successive 16-bit registers. Registers contain the same data as 32-bit registers of 7700 range. Registers can be read out and recorded.
7200	float (32 bits)	Value is placed in two successive 16-bit registers. Registers contain the same data as 32-bit registers of 7600 range. Registers can be recorded and read out.
7320	float (32 bits)	Value is placed in two successive 16-bit registers. Registers contain the same data as 32-bit registers of 7660 range. Registers can be read out and recorded or only recorded.
7500	float (32 bits)	Value is placed in 32-bit register. Registers are read-only.
7600	float (32 bits)	Value is placed in 32-bit register. Registers can be recorded and read out.
7660	float (32 bits)	Value is placed in 32-bit register. Registers can be read out and recorded or only read ut.
7700	float (32 bits)	Value is placed in 32-bit register. Registers can be recorded and read out.

6.5 Registers for recording and reading.

Value is placed in two successive 16-bit registers. These registers contain the same data as 32-bit registers of 7600 area.		Value is placed in 32-bit registers.		Symbol	Writing (w)/readout (r)	Range	Description
7200	7600	Identifier	o	—	device identifier		
					Value		
					226		NA5Plus
7202	7601	Channel number	w/r	0	Number of the meter channel		
					Value		
					0		Channel 1
7204	7602	Input type	w/r	0...16	Channel input type		
					Value		
					0		Pt100 RTD
					1		Pt500 RTD
					2		Pt1000 RTD
					3		J thermocouple
					4		K thermocouple
					5		N thermocouple
					6		E thermocouple
					7		R thermocouple
					8		S thermocouple
					9		T thermocouple
					10		Resistance measurement up to 10 kΩ
					11		Voltage measurement up to ± 75 mV
					12		Voltage measurement up to ± 300 mV
					13		Voltage measurement up to ± 10 V
					14		Voltage measurement up to ± 600 V
					15		Current measurement up to ± 40 mA
					16		Current measurement up to ± 5 A
7206	7603	LoIn	w/r	-1999... 9999	Lower value of the input range Caution! Changing the input type assigns standard values to the LoIn and HiIn variables.		
7208	7604	HiIn	w/r	-1999... 9999	Upper value of the input range		

					Operation function on channel	
7210	7605	Function	w/r	0...7	Value	
					0	Switched off
					1	Squaring
					2	Extraction of roots
					3	Re-recording from the channel
					4	Addition of channels
					5	Subtraction of channels
					6	Multiplication of channels
7	Division of channels					
7212	7606	TC compensation	w/r	0.0...999.9	Compensation of joints temperature °C Caution: entering values outside the range of 0.0..60.0°C will enable automatic compensation.	
7214	7607	Pt compensation	w/r	0.0...999.9	Compensation of wire resistance in Ω Caution: entering a value outside the range of 0.0 ... 40.0 Ω will enable automatic compensation.	
7216	7608	D_P	w/r	0...4	Channel decimal point	
					Value	
					0	0000
					1	000.0
					2	00.00
3	0.000					
4	Auto					
7218	7609	Cnt	w/r	0...999.9	Channel measurement time	
7220	7610	IndiPts	w/r	2...21	Number of the channel Individual characteristics points	
7222	7611	IndiOn	w/r	0...1	Channel individual characteristics	
					Value	
					0	Characteristics off
1	Characteristics on					
7224	7612	Unit	w/r	0...1	Temperature unit used in calculation	
					Value	
					0	Degrees Celsius °C
1	Degrees Farenheit F					
7226	7613	Reserved	-	-	Reserved value	
7228	7614	Bar graph number	w/r	0	Bar graph number	
					Value	
0	Bar graph of channel 1					
7230	7615	Bar graph type	w/r	0...4	Bar graph type	
					Value	
					0	One-colour (OnEC)
					1	Change of colour after exceeding the alarm threshold (the whole bar graph colour changes) (Intr)
					2	Change of colour after exceeding the alarm threshold (three-segment change of colour) (SEct)
3	One-colour bar graph, alarm markers in another colour (PInt)					
4	Increasing/decreasing trend (trEn)					
7232	7616	Colour	w/r	0...7	Bar graph colour	
					Value	
					0	Bar graph off (OFF)
					1	Red (r)
					2	Green (G)
3	Red + Green (rG)					
Other values are only available in meters with RGB diodes						

					4	Blue (b)
					5	Red + Blue (rb)
					6	Green + blue (Gb)
					7	Red + Green + Blue (rGb)
7234	7617	Brl	w/r	-1999... 9999	"Magnifier" on the bar graph Lower threshold	
7236	7618	Brh	w/r	-1999... 9999	"Magnifier" on the bar graph Upper threshold	
7238	7619	Alarm no.	w/r	0...7	Choice of alarm number Range of changes depends on the meter version code (number of alarms)	
7240	7620	Ch_Alarm	w/r	0	Channel number to which the alarm is to react <Alarm No.>	
					Value	
					0	Channel 1
7242	7621	Prl	w/r	-1999... 9999	Alarm lower threshold <Alarm no.>	
7244	7622	Prh	w/r	-1999... 9999	Alarm upper threshold <Alarm no.>	
					Alarm type <Alarm no.>	
					Value	
					0	Normal Switched on
					1	Normal Switched off
					2	Switched on
					3	Switched off
					4	Manual switched on
					5	Manual switched off
					6	Response to slope
7248	7624	Alarm delay	w/r	0...999.9	Alarm delay <Alarm no.>	
					Holding up the alarm signaling <Alarm no.>	
7250	7625	Holding up the alarm	w/r	0...1	Value	
					0	Hold up off
					1	Hold up off
					Bar graph colour to the lower alarm threshold <Alarm no.>	
					Value	
					0	Bar graph off (OFF)
					1	Red (r)
					2	Green (G)
					3	Red + Green (rG)
					Other values are only available in meters with RGB diodes	
					4	Blue (b)
					5	Red + Blue (rb)
					6	Green + blue (Gb)
					7	Red + Green + Blue (rGb)
					Bar graph colour after exceeding the upper alarm threshold <Alarm no.>	
					Value	
					0	Bar graph off (OFF)
					1	Red (r)
					2	Green (G)
					3	Red + Green (rG)
					Other values are only available in meters with RGB diodes	
					4	Blue (b)
					5	Red + Blue (rb)
					6	Green + blue (Gb)
					7	Red + Green + Blue (rGb)
7254	7627	CURH	w/r	0...7	Bar graph colour after exceeding the upper alarm threshold <Alarm no.>	
					Value	
					0	Bar graph off (OFF)
					1	Red (r)
					2	Green (G)
					3	Red + Green (rG)
					Other values are only available in meters with RGB diodes	
					4	Blue (b)
					5	Red + Blue (rb)
					6	Green + blue (Gb)
					7	Red + Green + Blue (rGb)

7256	7628	dErt	w/r	-1999... 9999	Value of change in the measured signal <Alarm no.>	
7258	7629	d_t	w/r	0...3600	Time of change in the measured signal <Alarm no.>	
7260	7630	Output number	w/r	0...1	Selection of the output to be configured.	
					Value	
					0	Output no. 1
		1	Output no. 2			
7262	7631	Chna	w/r	0...1	Selection of channel number for analog output <Output no.>	
					Value	
					0	Channel no. 1
		1	Channel no. 2			
7264	7632	Output characteristics	w/r	0...1	Analog output characteristics <Output no.>	
					Value	
					0	Characteristics off
		1	Characteristics on			
7266	7633	X1 LED	w/r	-1999... 9999	Analog output characteristics parameters <Output no.>	
7268	7634	Y1 Out	w/r	-1999... 9999	Analog output characteristics parameters <Output no.>	
7270	7635	X2 LED	w/r	-1999... 9999	Analog output characteristics parameters <Output no.>	
7272	7636	Y2 Out	w/r	-1999... 9999	Analog output characteristics parameters <Output no.>	
7274	7637	Baud rate	w/r	0...2	RS-485 interface baud rate	
					Value	
					0	2400 bit/s
					1	4800 bit/s
					2	9600 bit/s
					3	19200 bit/s
					4	57600 bit/s
5	115200 bit/s					
7276	7638	Operating mode	w/r	1...7	MODBUS protocol operation mode	
					Value	
					0	RTU 8N2
					1	RTU 8E1
					2	RTU 8O1
		3	RTU 8N1			
7278	7639	Address	w/r	0...247	Device address selection	
7280	7640	Recording	w/r	0...1	Measured value recording	
					Value	
					0	Recording off
		1	Recording from channel 1			
7282	7641	Interval	w/r	0... 99.5959	Time interval of recording	
7284	7642	Recording time	w/r	0... 23.5959	Recording start time	
					This parameter is displayed with four places after the decimal point in format hh,mmss, where: hh - means hours, mm - means minutes, ss - means seconds When incorrect time is entered, the indicator will correct it automatically.	
7286	7643	Year	w/r	1970... 2038	Year of recording start	
7288	7644	Month	w/r	1...12	Month of recording start	

7290	7645	Day	w/r	1...31	Day of recording start	
					Parameters Year , Month , and Day are information parameters (they are not used to specify the recording start date).	
7292	7646	Test	w/r	0...1	Display and bar graph test	
					Value	
					0	No operation
					1	Test
7294	7647	Hour	w/r	0... 23.5959	Current time	
					This parameter is displayed with four places after the decimal point in format hh,mmss, where: hh - means hours, mm - means minutes, ss - means seconds When incorrect time is entered, the indicator will correct it automatically.	
7296	7648	Erasing minimum	w/r	0...1	Erasing the minimum value	
					Value	
					0	No operation
					1	Erasing
7298	7649	Erasing maximum	w/r	0...1	Erasing the maximum value	
					Value	
					0	No operation
					1	Erasing
7300	7650	Reserved	-	-		
7302	7651	Reserved	-	-		
7304	7652	Restoring factory settings	w/r	0...1	Restoring factory settings of the meter.	
					Value	
					0	No operation
					1	Restoring
7306	7653	Menu access password	w/r	0...9999	The meter menu password readout or entering. Entering the value 0 deletes the password.	
7308	7654	Software version	o		Displays the software version in the MAJOR*100+MINOR format	
7320	7660	Year of the saved value	w/r	1970... 2038	Year of the saved value in memory	
7322	7661	Month of the saved value	w/r	1...12	Month of the saved value in memory	
7324	7662	Day of the saved value	w/r	1...31	Day of the saved value in memory	
7326	7663	Time of the saved value	w/r	0... 23.5959	Time of the saved value in memory	
					This parameter is displayed with four places after the decimal point in format hh,mmss, where: hh - means hours, mm – means minutes, ss - means seconds When incorrect time is entered, the indicator will correct it automatically.	
7328	7664	Index of the saved value	w/r	1...800	Number of the saved value in memory	
7330	7665	Status	w/r	0...7	Operation status at the buffer	
					Value	
					0	No operation
					1	Searching acc. date and time (registers no. 7660...7663 and 7320...7326)

					2	Searching acc. time (registers no. 7663 and 7326)
					3	Searching acc. index (registers no. 7664 and 7328)
					4	Load next values into the buffer (registers 7672...7691 and 7344...7382)
					5	Load previous values into the buffer (Registers 7672...7691 and 7344...7382)
					6	Go to the first saved value in memory.
					7	Go to the last saved value in memory.
7332	7666	Number of the saved value	o	0...800	Number of saved value in memory, placed in the first register of the buffer	
					Value	
					0	Memory is empty
					1...800	Number of the saved value
7334	7667	Number of recorded registers	o	0...20	Number of recorded buffer registers	
					Value	
					0	Buffer is empty
					1...20	Number of recorded registers
7336	7668	Year	o	1970...2038	Year for the value in the first register	
7338	7669	Month	o	1...12	Month for the value in the first register	
7340	7670	Day	o	1...31	Day for the value in the first register	
7342	7671	Time	o	0...23.5959	Time for the value in the first register	
					This parameter is displayed with four places after the decimal point in format hh,mmss, where: hh - means hours, mm - means minutes, ss - means seconds	
7344	7672	Buffer	o	—	Saved values, read out from the memory	
... 7382	... 7691				20 registers , including 20 saved values.	

Value is placed in two successive 16-bit registers. These registers contain the same data as 32-bit registers of 7700 area.	Value is placed in 32-bit registers.	Symbol	Writing (w)/ readout (r)	Range	Description
7100-7140	7700-7720	X values	w/r	-1999... 9999	X values of the device individual characteristics
7142-7182	7721-7741	Y values	w/r	-1999... 9999	Y values of the device individual characteristics

0 – two-colour RG	Bit-9...8 FRAM memory status
1 – seven-colour RGB	00 – no errors
Bit-20 Reserved	01 – memory full
Bit-19 Reserved	10 – memory damaged
Bit-18 Reserved	Bit-7 Alarm 8 status
Bit-17 Error of the conductor resistance compensation	0 – off
0 – no error	1 – on
1 – signalling of the compensation error	Bit-6 Alarm 7 status
Bit-16 Signalling of the upper range exceeding	0 – off
0 – normal operation	1 – on
1 – range exceeding	Bit-5 Alarm 6 status
Bit-15 Signalling of the lower range exceeding	0 – off
0 – normal operation	1 – on
1 – range exceeding	Bit-4 Alarm 5 status
Bit-14...13 Analog output type 2	0 – off
00 – none	1 – on
01 – current	Bit-3 Alarm 4 status
10 – voltage	0 – off
Bit-12...11 Analog output type 11	1 – on
00 – none	Bit-2 Alarm 3 status
01 – current	0 – off
10 – voltage	1 – on
Bit-10 Calibration status	Bit-1 Alarm 2 status
0 – meter not calibrated	0 – off
1 – meter calibrated	1 – on
	Bit-0 Alarm 1 status
	0 – off
	1 – on

7. Meter configuration with E-Con software

NA5Plus meter can be configured using the E-Con software. This program is a free application available on the manufacturer's website (www.lumel.com.pl). The meter should be connected to PC via RS485 interface. After starting the program, select the serial port to which the meter is installed. Available serial ports and connection configurations are available in the "Communication" tab.

When connected via the RS485 interface, set the following transmission parameters: the address (device ID), the speed and mode. Factory settings of RS485 interface are as follows: Address 1, speed 15200, mode RTU 8N1.

After setting the parameters, select the "connect" key.

Before changing the configuration of the meter, it is advisable to read and save the current configuration to a file to be able to restore the previous configuration. From e-Con application menu it is possible to save the configuration to a file, to read the file and also export the configuration to a pdf file.

After connection, e-Con automatically read the current configuration from the device. The parameters available for configuration, as well as a preview of the currently measured values at the inputs, are available in the right part of the main program window.

8. METER PROGRAMMING EXAMPLES

Example 1. Programming of individual characteristics.

We want to program the meter so that the measured value 4.00 mA corresponds to the value 0 on the display, while the measured value 20.00 mA corresponds to the value 100. To do this:

- set the display precision to 0000 (parameter $d.P = 0000$)
- enable individual characteristics (parameter $i.ndi = 0n$)
- set the number of characteristics points to 2 (parameter $Pt5 = 2$)
- set the point $i.H01 = 4.00$ and $dY01 = 0$
- set the point $i.H02 = 20.00$ and $dY02 = 100$

Example 2. Programming of the reverse individual characteristics.

If we want to program the meter so that the measured value 4.00 mA corresponds to the value 120.5 on the display, and the measured value 20.00 mA to value 10.8, we should:

- set the display precision to 000.0 (parameter $d.P = 000.0$)
- enable individual characteristics (parameter $i.ndi = 0n$)
- set the number of characteristics points to 2 (parameter $Pt5 = 2$)
- set the point $i.H01 = 4.00$ and $dY01 = 120.5$
- set the point $i.H02 = 20.00$ and $dY02 = 10.8$

Example 3. Programming the alarm with hysteresis

If we want to program the alarm 1 operation so that at the value of 850 °C for the input the alarm is switched on and at 100 °C it is switched off:

- set the lower alarm threshold 1 to 100 ($P_{rL} = 100$)
- set the upper alarm 1 threshold to 850 ($P_{rH} = 850$)
- set alarm type 1 as normally enabled (parameter $tYPA = n_0n$)

Example 4. Programming the alarm in a desired interval with a delay

If we want to program the alarm 1 operation so that it is switched on in the range of 100 V to 300 V for the input, but with a delay of 10 seconds, then:

- set the lower alarm threshold 1 to 100 ($P_{rL} = 100$)
- set the upper alarm 1 threshold to 300 ($P_{rH} = 300$)
- set alarm type 1 as normally enabled (parameter $typA = 0n$)
- set the alarm 1 delay to 10 seconds (parameter $dLY = 10$)

If the alarm condition lasts longer than 10.0 seconds, the meter will activate the alarm output.

Example 5. Analog output programming

If we want to program the current output of the meter so that the measured value of 0.00 mA for the input corresponds to 4.00 mA on the output, while the measured value 20.00 mA corresponds to 20.00 mA, we should:

- enable individual characteristics for the output (parameter $i.nd0 = 0n$)
- set the first point of the characteristics: $d.H1 = 0.00$, $0.Y1 = 4.00$
- set the second point of the characteristics: $d.H2 = 20.00$, $0.Y2 = 20.00$

Example 6. Bar graph programming

If we want to program the bar graph 1 as a sector - the red colour between the P_{rL} and P_{rH} parameters:

- for the bar graph, set the $tYPb = SEct$ parameter
- for the bar graph set the $colr = r$ parameter

Example 7. Programming the magnifier on the bar graph

If we want to program the bar graph to be blanked for the value 0, and for the value 150 to be fully lit, we should:

- for the bar graph, set the $brL = 0$ parameter
- for the bar graph, set the $brH = 150$ parameter



Example 8. Recording programming

If we want to program the recording of the input every 20 seconds from 12:30, we should:

- set the recording date and time for input 1 (parameters Hr_1 , dR_1)
- set the input 1 recording interval to 20 seconds (parameter Int_1)

9. BEFORE YOU REPORT A DEFECT

In the case of improper operation of the meter, verify the fault in the following table:

Symptom	Procedure
There are no indications on the display, the bar graph indicates nothing.	Check the meter power supply connection
The display shows the time, e.g. H_12 alternately with 20:43	The averaging time $Cnt = 0$ has been introduced, the meter operates in sleep mode and displays the current time
The display shows the characters:  or 	Check the correctness of the input signal connection. See the service manual. Check also the setting of parameters D_P , Ind , $Loln$ and $Hiln$.
A signal that does not meet our expectations appears on the analog output of the meter	Check if the resistance of the analog output is in accordance with the technical data. Check if the individual characteristics for the output is not switched on. If necessary, change the parameters of the characteristics or enter factory parameters.
It is not possible to enter the programming mode, request for an access code	The programming mode is password protected. You must enter the correct password. If the user has forgotten the password, please contact the service
It is not certain whether all segments of the display or bar graph are in working order	Enter the meter menu and enable the test of displays and bar graphs. The character fields are lit successively from 0000 to 9999, at the same time the subsequent colours of bar graphs are lit. If any display segment or bar graph point does not light, report the fault to the nearest service centre
While navigating the meter's menu, the parameter values that do not match the scope of their changes appear on the display.	Enter the meter menu and reset the meter to its factory settings.
The display shows a result that is not in line with our expectations	Check if the individual characteristics is not switched on. If necessary, restore the meter factory parameters.

The bar graph does not work as we expect	Check the parameters of the bar graph. In case of further incorrect operation, restore the meter factory parameters and perform a display test.
Despite exceeding the alarm threshold, the alarm relay does not turn on	Check and if necessary correct the value of the alarm delay.
Instead of displaying the measurement result, the meter displays the parameter symbol and its value	The meter operates in the parameter preview mode or in the programming mode. Press the cancel key.
A delay in the activation of the alarm was introduced, e.g. 30 s, but the alarm did not work after this time	The duration of the alarm occurrence condition was shorter than the programmed one, i.e. the alarm condition subsided before the delay time elapsed. In this case, the meter starts counting down the time from the beginning
The meter does not establish communication with the computer via the RS-485 interface	Check if the interface cables (A, B, GND) have been correctly connected and then check the interface parameters in the meter menu. These parameters must be compatible with those in the software used

10. SOFTWARE UPDATE

The meter software update can be done via a PC with installed free e-Con program. e-Con program and the current update file are available on the website www.lumel.com.pl. Update can be performed via the RS-485 interface.

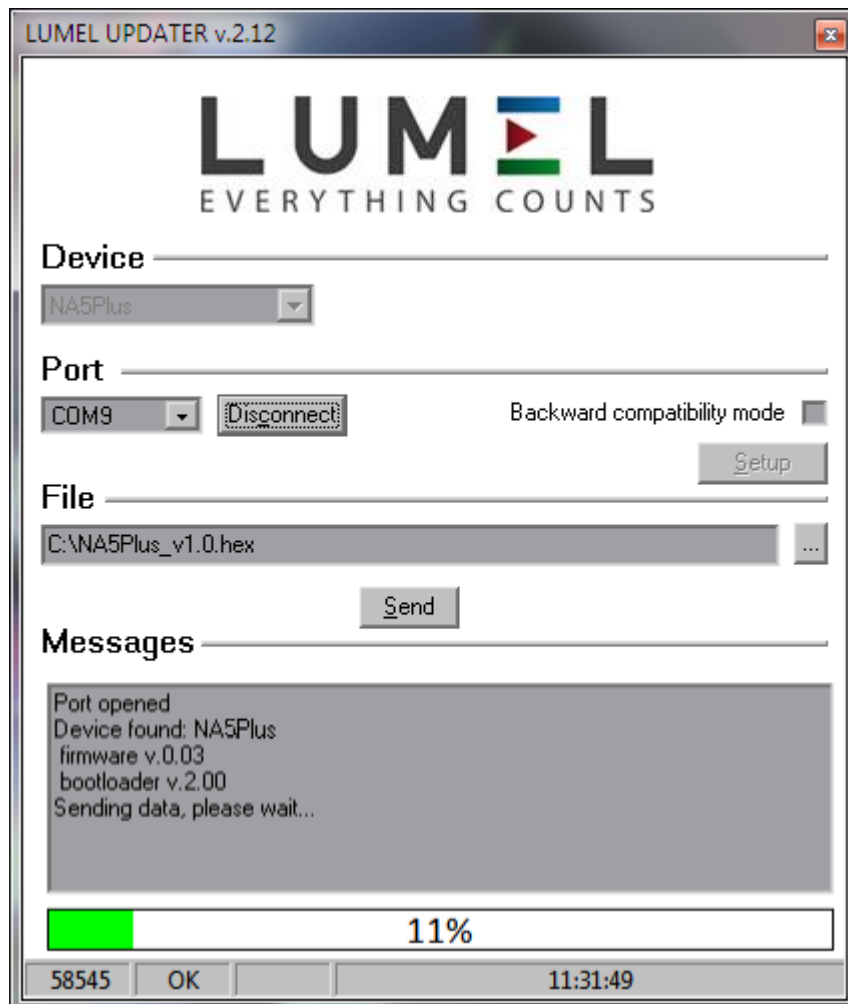

Fig 13: Software update

Caution! It is recommended that before updating the meter software, the user should read and save the current configuration of the meter to a file.

After starting the e-Con, set the communication parameters in the *Communication* field on the left side of the main window, then select *Connect*. The meter will be automatically recognized.

When communication is established it is recommended to read the current configuration of the module and save it to a file, for later restoration.

Then select *Firmware Update* on the right side of the program menu. LUMEL UPDATER (LU) will be launched (Fig. 16). NA5Plus meter is supported by LU starting from version 2.09. Select the device (NA5Plus) in the program, the port on which the device is installed in Windows, set the appropriate transmission parameters (115200, 8n1) in the access window under *Setup*, and indicate the update file. Then establish connection using *Connect* button. The Messages window

displays information about the detected device and the update progress. After the meter is properly detected by LU, you must start the update by selecting *Send* button. LU will show the update progress bar with percentage information, and the NA5Plus meter will indicate the updating process on the display throughout the update. After the update is completed, the meter will restart, restore factory parameters and start normal operation. LU message window will display *Done* and the meter update duration. LU program can be closed and then we can read the previous configuration from the file and save it to the meter using e-Con.

Caution! If the connection is interrupted or the power is turned off while updating the meter software, it may cause permanent damage to the device.

11. TECHNICAL DATA

Input:

Pt100	(-200...850) °C	
Pt500	(-200...850) °C	
Pt1000	(-200...850) °C	
J (Fe-CuNi)	(-100...1100) °C	
K (NiCr-NiAl)	(-100...1370) °C	
N (NiCrSi-NiSi)	(-100...1300) °C	
E (NiCr-CuNi)	(-100...850) °C	
R (PtRh13-Pt)	(0...1760) °C	
S (PtRh10-Pt)	(0...1760) °C	
T (Cu-CuNi)	(-50...400) °C	
Resistance measurement	0...10 kΩ	
Voltage measurement	-75...75 mV	input resistance > 100 kΩ
Voltage measurement	-300...300 mV	input resistance > 100 kΩ
Voltage measurement	-10...10 V	input resistance > 3.5 MΩ
Voltage measurement	-600...600 V	input resistance > 3.5 MΩ
Current measurement	-40...40 mA	input resistance < 4 Ω
Current measurement	-5...5 A	input resistance 10 mΩ ±10 %

Current flowing through the resistance thermometer: < 400 μA

Resistance of conductors linking the resistance thermometer with the meter: < 20 Ω/wire

Thermocouple characteristics according to EN 60584-1

Resistance thermometer characteristics acc. IEC 751+A1+A2

Outputs:

Analog outputs galvanically isolated

- current 0/4...20 mA load resistance ≤ 500 Ω
- voltage 0...10 V load resistance ≥ 500 Ω
- output error 0.2 %
- additional error due to ambient temperature changes ±(0.1 % of the range / 10 K)

Relay outputs

- 4 relays; potential free - make contacts, maximum load:
- voltage 250 V AC/ 150 V DC
- current 5 A 30 V DC, 250 V AC.
- resistive load 1250 VA, 150 W

Transistor:

- 8 open collector (OC) outputs, maximum load:
- voltage 5...30 V DC
- current 25 mA DC

Digital:

- interface RS-485
- protocol MODBUS RTU
- transmission type 8N2, 8E1, 8O1, 8N1
- baud rate 2400, 4800, 9600, 19200, 57600, 115200 b/s,
- maximum response time 500 ms

Additional supply output 24 V DC, maximum load 30 mA

Memory parameters:

- meter memory (recording) 800 samples (input 1 or input 2), or 400 samples (channel 1) + 400 samples (channel 2)
- min. recording interval 1 s

Basic error: 0.1% of measuring range @1 digit
0.2% of measuring range @1 digit (for thermocouples R, S, T)

Additional errors in rated operating conditions:

- compensation of reference joints temperature changes $\leq \pm 1 \text{ }^\circ\text{C}$
- compensation of lead resistance changes

when the resistance of conductors is changed, $< 10 \text{ } \Omega$ $\leq \pm 0.5 \text{ }^\circ\text{C}$

when the resistance of conductors is changed, $< 20 \text{ } \Omega$ $\leq \pm 1 \text{ }^\circ\text{C}$

- from ambient temperature changes $\leq \pm(0.1 \text{ \% of the range} / 10 \text{ K})$

Averaging time: $\leq 0.5 \text{ s}$ (default)

Nominal operating conditions:

- supply voltage 95...253 V AC40..400 Hz; 90...300 V DC
20...40 V AC40...400 Hz, 20...60 V DC
- ambient temperature -10...23...+55 $^\circ\text{C}$
- storage temperature -25...+85 $^\circ\text{C}$
- humidity $< 95\%$ (without condensation)
- external magnetic field 0..40..400 A/m
- operation position vertical
- warm-up time 30 min.

Degree of protection IP:

from the front	IP 50
from the terminals	IP 20

Test voltage:

2210 V AC rms 1 minute between housing / power supply and:

- RS485
- binary outputs
- analog inputs

1390 V AC rms 1 minute between:

- analog inputs / RS485
- analog inputs / binary outputs
- RS485 / binary outputs

Power consumption:	≤ 13 VA
Weight	< 0.4 kg
Dimensions	48 X 144 X 100 mm

EMC compatibility:

- immunity to interference in accordance with EN 61000-6-2
- interference emission in accordance with EN 61000-6-4

Safety requirements:

in accordance with the standard EN 61010-1

- insulation between circuits basic
- installation category III,
- degree of pollution 2,
- maximum voltage relative to earth:
 - for power circuit 300 V
 - for input circuit 600 V
 - for other circuits 50 V
- altitude < 2000 m

12. ORDERING CODES

NA5Plus meter	-	X	X	X	X	X	X	XX	X	X	
Bar graph colour	three-colour (R, G)	T									
	seven-colour (R, G, B)	M									
The colour of displays on channels 1 and 2	red	R									
	green	G									
	on request *)	X									
Input signal	universal inputs	U									
	on request *)	X									
Analog output signals	none	0									
	current 0/4..20 mA	1									
	voltage 0..10 V	2									
	2 x current 0/4..20 mA	3									
	2 x voltage 0..10 V	4									
	current 0/4..20 mA and voltage 0..10 V	5									
Alarm outputs	none	0									
	4 relay outputs	4									
	8 OC type outputs	8									
Power supply	95..253 V a. c. / d. c.	2									
	20..40 V AC 20..60 V DC.	4									
Version	standard	00									
	special *)	XX									
Language	Polish	P									
	English	E									
	other *)	X									
Acceptance tests:	without additional requirements	0									
	with quality inspection certificate	1									
	acc. to customer's requirements *)	X									

*)After agreement with the manufacturer

SAMPLE ORDER:

The code NA5Plus-TGU18200E0 means:

NA5A – NA5A meter

T – RG bar graph

G – display in green colour

U – universal inputs

1 – current output 0/4...20 mA

8 – 8 binary OC outputs

2 – power supply 95..253 V a. c. / d. c.

00 – standard version,

E – English language version,

0 – without additional requirements.



LUMEL S.A.

ul. Sulechowska 1, 65-022 Zielona Góra, POLAND

tel.: +48 68 45 75 100, fax +48 68 45 75 508

www.lumel.com.pl

Export department:

tel.: (+48 68) 45 75 139, 45 75 233, 45 75 321, 45 75 386

fax.: (+48 68) 32 54 091

e-mail: export@lumel.com.pl