

SYNCHRONIZING UNIT
KS5



USER'S MANUAL



Contents

1	APPLICATION.....	2
2	METER SET.....	2
3	BASIC REQUIREMENTS, OPERATIONAL SAFETY.....	3
4	INSTALLATION.....	4
5	DESCRIPTION OF THE INSTRUMENT.....	5
5.1	Voltage inputs.....	5
5.2	External connections diagram.....	5
6	KS5 PROGRAMMING.....	7
6.1	General description.....	7
6.2	Starting operation.....	10
7	CONFIGURATION OF THE METER.....	10
	PARAMETERS.....	10
7.1	Measurement.....	12
7.2	Parameters.....	12
7.3	Relays.....	14
7.4	Ethernet.....	16
7.5	Modbus.....	17
7.6	Settings.....	18
7.7	Information.....	18
8	SERIAL INTERFACES.....	19
8.1	RS485 INTERFACE – the list of parameters.....	19
8.2	Examples of registers reading and saving.....	19
8.3	Ethernet 10/100-BASE-T.....	22
8.3.1	Connection of 10/100 BASE-T interface.....	22
8.3.2	Web Server.....	23
8.3.3	Modbus TCP/IP.....	25
9	MAP OF REGISTERS OF KS5 METER.....	25
10	FIRMWARE UPGRADE.....	30
11	ERROR CODES.....	31
12	TECHNICAL DATA.....	31
13	ORDERING CODES.....	33

1 APPLICATION

The KS5 digital synchronizing unit has been designed for the synchronization of generators switched for parallel operation with the grid or with other generators with rated frequency of 50 or 60 Hz. Frequency differences, voltage values, and phase shifts are shown on a 3.5" color TFT display screen with a resolution of 320 x 240 pixels.

Bar graphs with zero in the middle marked δf and δU indicate respectively the difference in frequency and the difference in voltage values of the generator and network signals. Phase shift φ of the generator and network voltage signals is indicated by a circular synchronoscope. The spin speed corresponds to the difference between the network and the generator frequency.

The synchronization point, i.e. the moment when the frequency, voltage and phase values of the generator and the network are equal, is indicated by green indicators on the bar graphs and inside the circle. With proper control of the BLK and START signals (detailed in p.7.3), the SYNC synchronization relay will be activated.

The values of the measured quantities and deviations can be transferred to the master system via RS485 interface or Ethernet.

The synchronizing unit has a galvanic separation between the individual blocks of:

- power supply,
- voltage inputs,
- Input control signals,
- RS485 Interface,
- Ethernet Interface:
- relay outputs

2 METER SET

Complete set of the Analyzer includes:

- | | |
|-----------------------------------------------------|--------|
| 1. KS5 synchronizing unit | 1 pc. |
| 2. gasket | 1 pc. |
| 3. mounting brackets to fix the device in the panel | 4 pcs. |
| 4. connector with 16 screw terminals | 1 pc. |
| 5. connector with 14 screw terminals | 1 pc. |

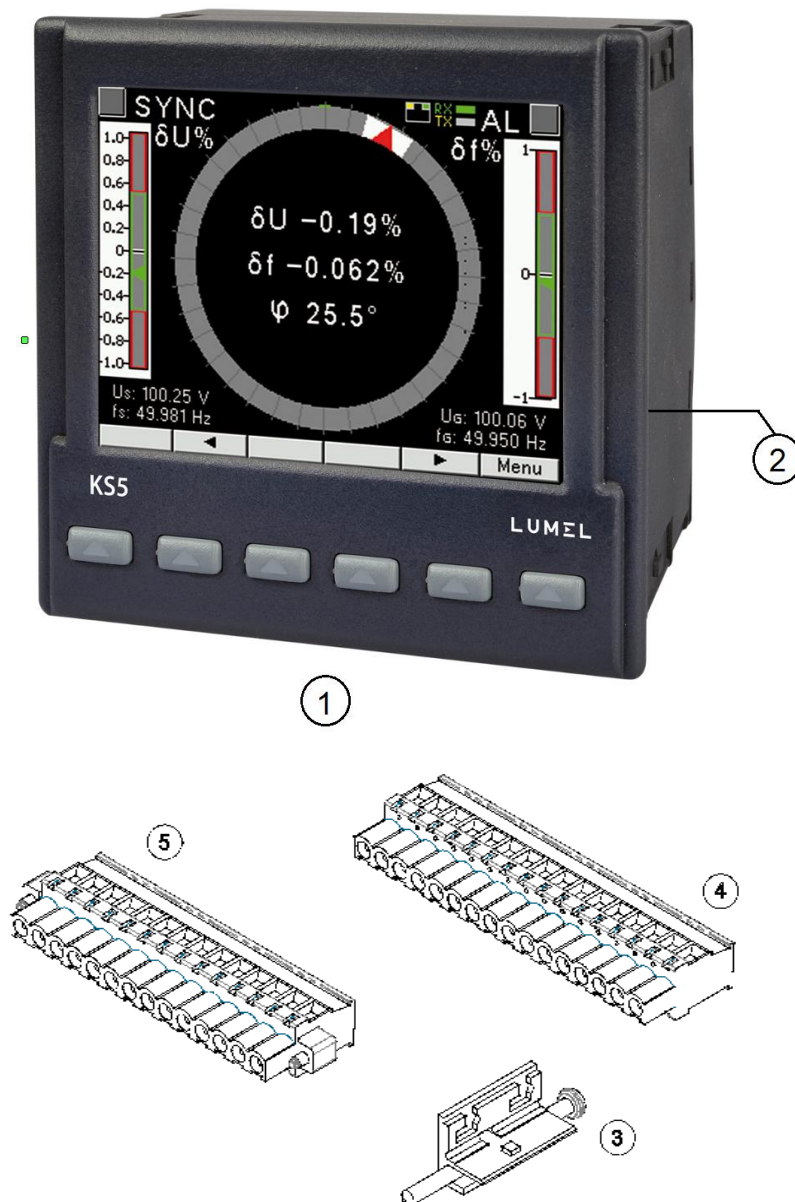

Fig.1, Meter set

3 BASIC REQUIREMENTS, OPERATIONAL SAFETY

In terms of operational safety the synchronizing unit meets the requirements of DIN EN 61010-1.

Safety instructions: 

- The meter installation and connection should be made by qualified personnel. All available protection requirements must be taken into consideration.
- Prior to turning the meter on verify the connections.
- Prior to removing the meter housing, always turn the supply off and disconnect the measurement circuits.
- Removal of the meter housing during the warranty period voids the warranty.
- The synchronizing unit meets the requirements for electromagnetic compatibility in industrial environment.
- A switch or a circuit-breaker should be installed inside the building or facility. It should be located near the device, easily accessible to the operator, and suitably marked.

4 INSTALLATION

The synchronizing unit is adapted to be fixed to the panel by means of mounting brackets, according to fig. 1. The housing is made of self-extinguishing plastic.

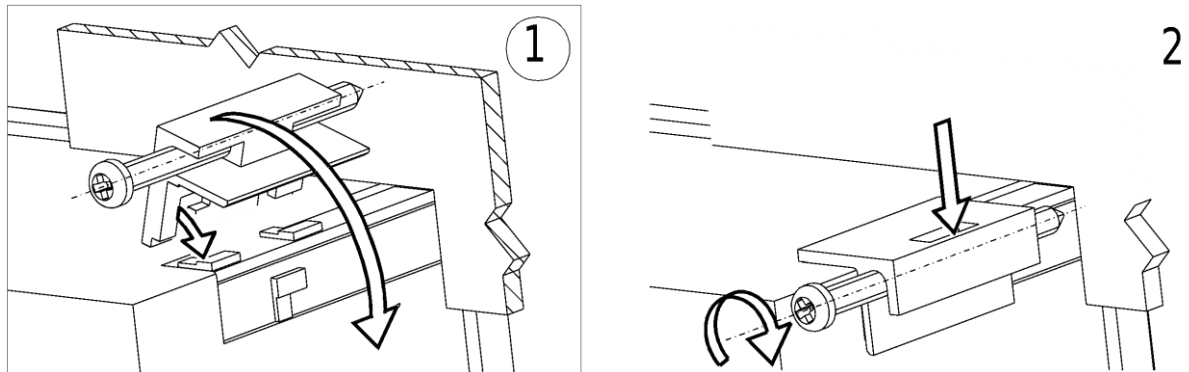

Fig.2. Meter fixing

Housing dimensions 96 x 96 x 77 mm, mounting hole dimensions 92.5 x 92.5 mm. Outside the meter there are screw terminals that allow connection of external wires with a cross-section up to 2.5 mm².

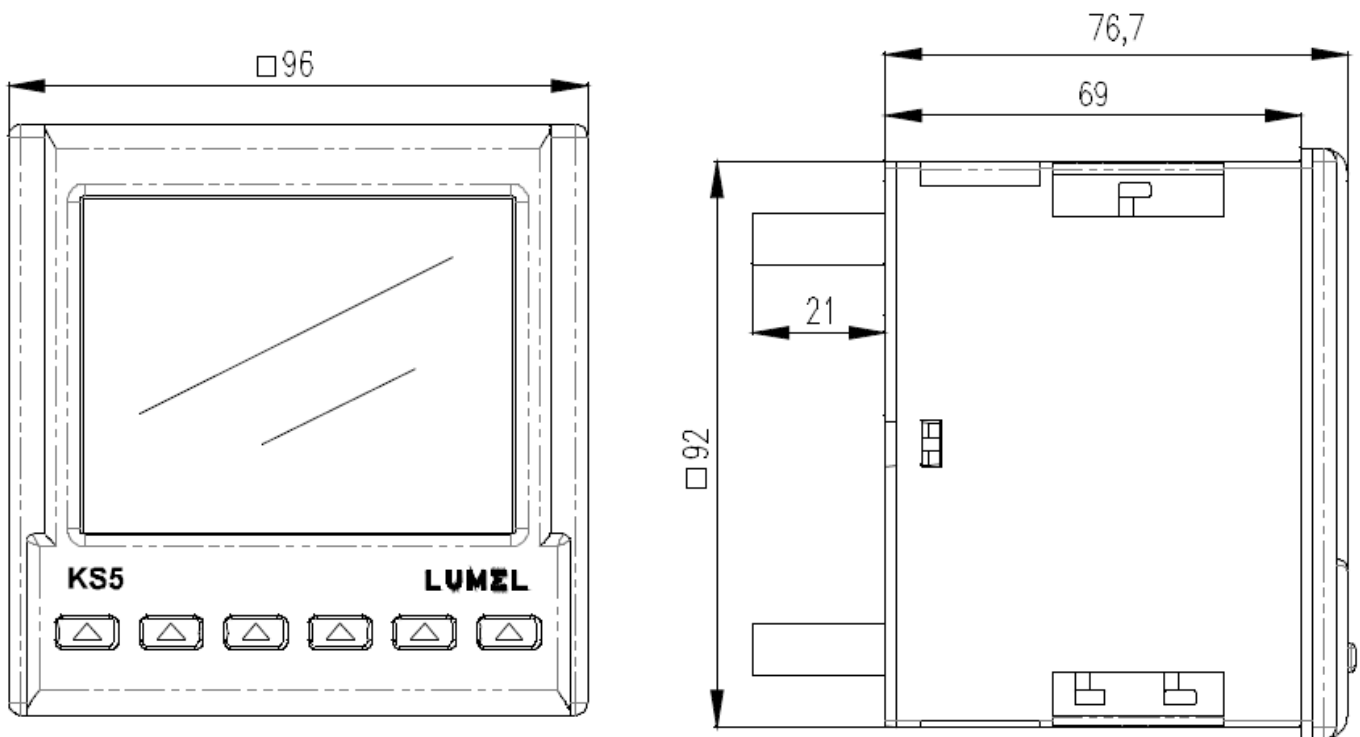

Fig.3. Overall dimensions of KS5 meter

5 DESCRIPTION OF THE INSTRUMENT

5.1 Voltage inputs

Voltage inputs are galvanically isolated (internal transformers). Un voltages (phase or phase-to-phase) are automatically recalculated by the input value of the external voltage transformer ratio. The voltage inputs specified in the order as 50...150 V or 150...400 V are programmable in the selected range. Maximum operating voltage relative to earth is 300 V.

5.2 External connections diagram

External connections are shown in Figures 4a, 4b.

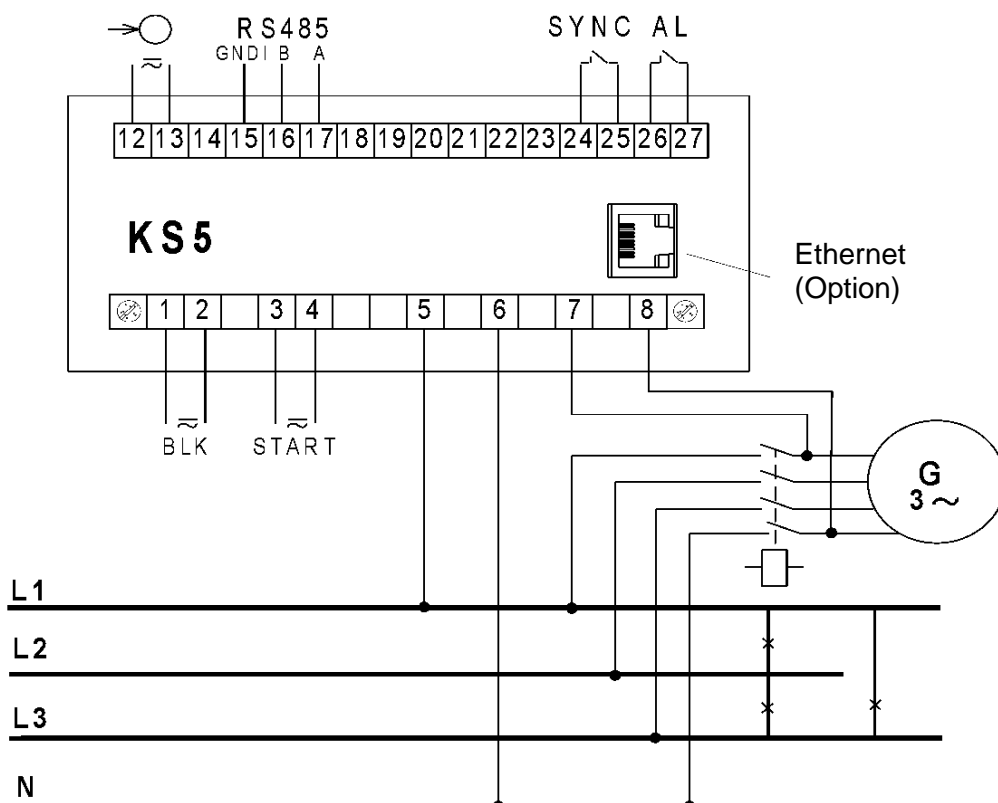

Fig. 4a. Connections of the synchronizing unit - phase measurement voltages

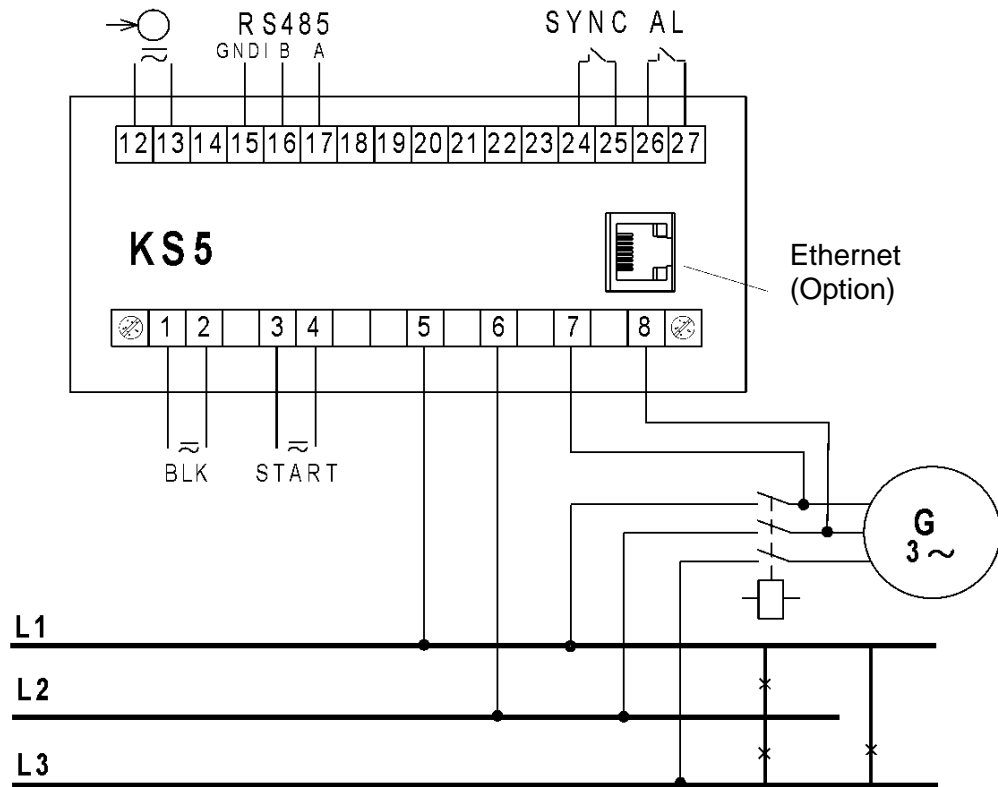

Fig. 4b Connections of the synchronizing unit - phase-to-phase measurement voltages

6 KS5 PROGRAMMING

6.1 General description



Fig.5, Front panel

KS5 synchronizing unit has 6 buttons and a graphical color display.

Description of the front panel:

V, Hz, °,% units of displayed quantities

K kilo = 10^3 ,

U_S, f_S , Indications of displayed parameters

U_G, f_G

$\delta f, \delta U, \phi$

Input measuring signals:

U_S - network voltage, f_S – network frequency,

U_G - generator voltage, f_G – generator frequency,

Input control signals:

BLK - synchronization lock (SYNC relay will not be activated even if the other synchronization conditions are met)

START - start of synchronization - unlocking the SYNC relay. After the START signal, the meter expects that measured values of the voltage δU and frequency δf difference and the phase shift ϕ of the voltage signals from the generator and the network will be within the set admissible values, then it generates a pulse that activates the SYNC relay with the set lead in time.

Output signals (relay contacts):

- AL - fault relay is activated in case of faulty external circuit connection when a fault occurs and if the measured values are outside the measuring range,
- SYNC - synchronization relay,

Calculated values:

δf , δU - difference in frequency and difference of voltage values of the generator and network signals,

ϕ - phase shift of the generator and network voltage signals,

The SYNC synchronization relay will be energized after synchronization conditions have been met.

Synchronization conditions:

$$-\delta U \leq \delta U \leq +\delta U$$

$$-\delta f \leq \delta f \leq +\delta f$$

$$|\phi| \leq \Delta\phi$$

BLK = "0"; START = "1" (detailed description in p. 7.3 Relays)

where:

$-\delta U$ - lower limit of voltage difference during synchronization,

$+\delta U$ - upper limit of voltage difference during synchronization,

$-\delta f$ - acceptable frequency difference when connecting "from below",

$+\delta f$ - acceptable frequency difference when connecting "from above",

ϕ - phase shift,

$\Delta\phi$ - acceptable phase shift,

The difference in the values of the voltage and frequency of the generator U_G, f_G and network U_S, f_S is calculated according to the formulas:

$$\delta U = 100 (U_G - U_S) / U_S [\%]$$

$$\delta f = 100 (f_G - f_S) / f_S [\%]$$

The phase shift of the generator voltage U_G relative to the network voltage U_S is expressed in degrees:

$$\phi = \angle (U_G, U_S) [^\circ]$$

Fixed phase shift compensation: positive value means that the generator voltage U_G is ahead of the network voltage U_S .

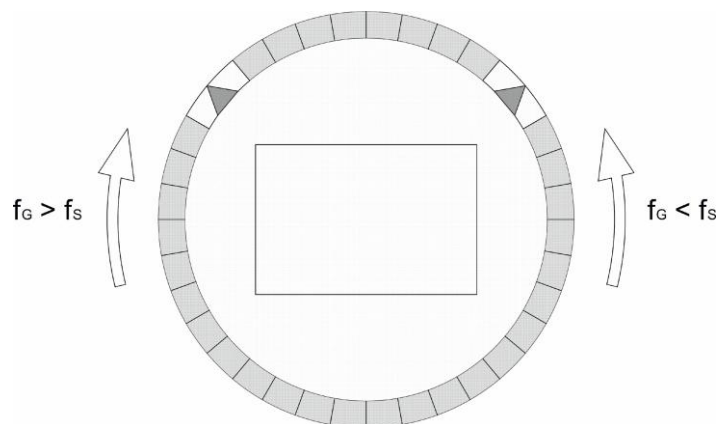

Fig.6, Synchronoscope with phase shift visualization

The spin speed and direction correspond to the difference between the network and the generator frequency.

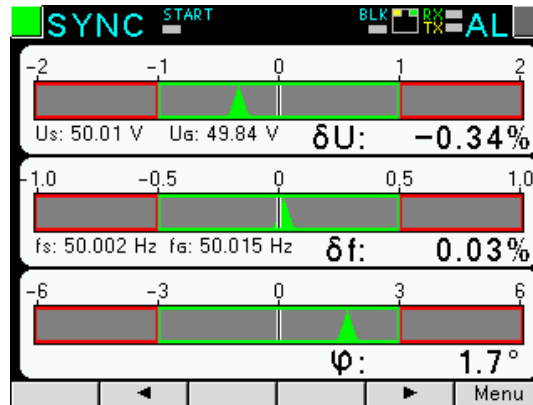

Fig.7, Screen when synchronization conditions are met

The values of measured parameters are presented on the next pages selected by pressing the following buttons: (next page) or (previous page).

Meter buttons can perform various functions depending on the operating location. Functions are described on the bar at the bottom of the screen. If no description is present, it means that the button is inactive at that moment.

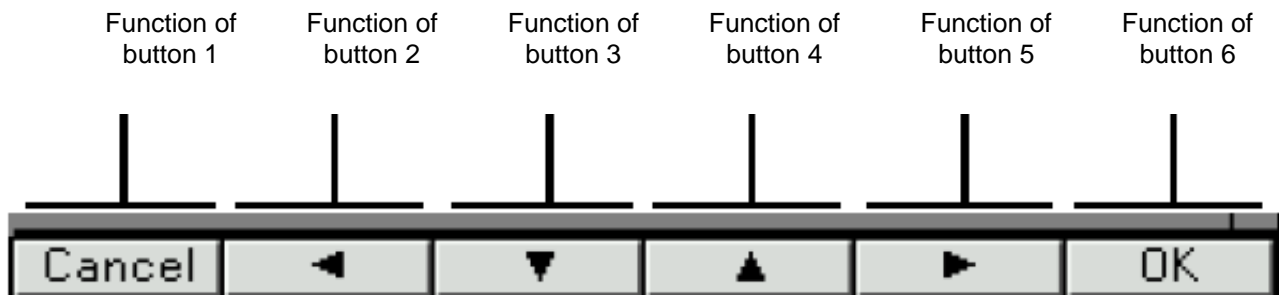

Fig.8, Sample designation of buttons

The top of the screen shows the status of the relay outputs (SYNC, AL), the status of control input signals START, BLK, the Ethernet connection symbol , indicators of receipt and transmit of the data at RS485 (RX, TX)

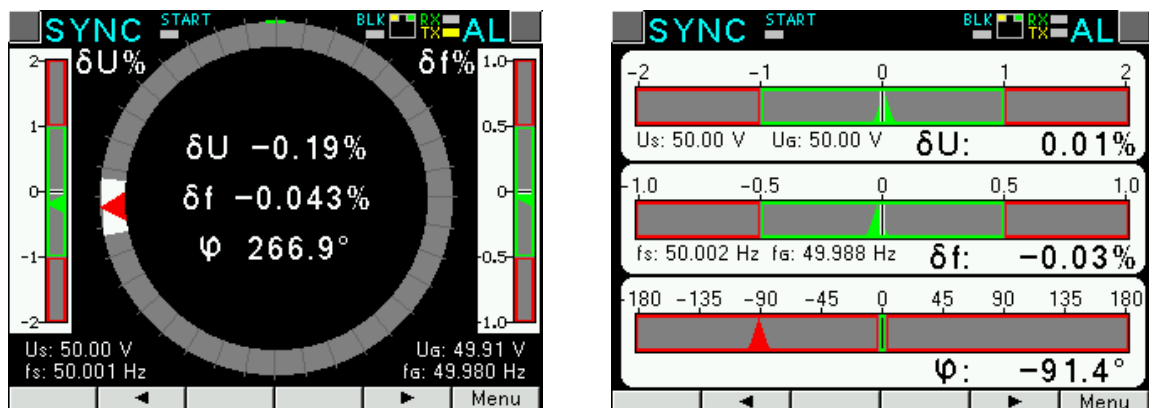

Fig.9, Visualization of measurements (synchronoscope, bar graphs)*

*The phase shift range on the synchronoscope screen: 0..360°,
 the phase shift range on the bar graphs screen: -180..+180°

6.2 Starting operation

When power is turned on, the synchronizing unit displays the logo, KS5 meter name, version, current firmware version and MAC for versions with Ethernet, and then switches to measurement mode. Displayed information:

- KS5 v:1.00– type of the synchronizing unit, program version number
- Bootloader v.01.05 bootloader version number
- U: 50...150 V – voltage version
- MAC: AA:BB:CC:DD:EE:FF (versions with Ethernet)

7 CONFIGURATION OF THE METER PARAMETERS

During normal operation (**Measurement**) the unit displays and signals the values that characterize the state and the course of the generator synchronization process. The KS5 meter performs voltage measurement functions (voltage difference), frequency (frequency difference), and phase shift between the voltage signals of the network and the generator.

The meter menu is divided into the following groups:

- Parameters** – configuration of parameters of the meter,
- Relays** – configuration of SYNC and AL relays,
- Ethernet** – configuration of Ethernet interface parameters,
- Modbus** – configuration of RS485 interface parameters,
- Settings** - settings: password, language, brightness level,
- Information** – preview of program version, serial no., MAC address,

To enter the parameter menu, press the button  for about 3 seconds.

Use the buttons   to select the desired group and accept with the button 

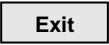
Return to normal operation by pressing the button 

Parameters	Primary voltage of transformer	Secondary voltage of transformer	Compensation of fixed phase shift	Default settings of parameters
	0000100	00100.0	±000,0	<input checked="" type="checkbox"/> No <input type="checkbox"/> Yes

Fig. 10a. Programming matrix

Relays	SYNC	Low value of voltage difference -δU [%] 000.0	High value of voltage difference δU [%] 000.0	Acceptable freq. difference at down -δ[f] 000.00	Acceptable freq. difference at up δ[f] 000.00	Down switching acceptable ZL- <input checked="" type="checkbox"/> Yes <input type="checkbox"/> No	Up switching acceptable ZL+ <input checked="" type="checkbox"/> Yes <input type="checkbox"/> No
		Acceptable phase shift Δφ [°] 000.0	Relay lead time t _b SYNC [ms] 000	Pulse mode <input checked="" type="checkbox"/> permanent switching <input type="checkbox"/> switching pulse	Width of the switching pulse [ms] 000	Input signals BLK, START <input checked="" type="checkbox"/> Active <input type="checkbox"/> Inactive	Set defaults <input checked="" type="checkbox"/> No <input type="checkbox"/> Yes
	AL	Relative voltage difference δU [%] ≥ 000.0	Relative frequency difference δf [%] ≥ 000.0	Phase shift Δφ [°] ≥ 000.0	Set defaults <input checked="" type="checkbox"/> No <input type="checkbox"/> Yes		

Fig. 10b. Programming matrix

Ethernet	Addresses	DHCP <input type="checkbox"/> Deact. <input checked="" type="checkbox"/> Act.	Mode <input type="checkbox"/> Auto <input checked="" type="checkbox"/> 10Mb/s <input type="checkbox"/> 100Mb/s	IP Address 00.000.000.000	Subnet Mask 255.255.255.000	Gateway Address 000.000.000.000	DNS Address 008.008.008.008	MAC Address aa.bb.cc.00:21:01
		Acquired from DHCP or entered manually when DHCP is deactivated.						
	Modbus TCP	Address 001	Port 00502	Max. connection limit 1	Waiting time [s] 001			
WWW	Port 00080							



Fig. 10c. Programming matrix

Modbus	Address 001	Baudrate <input type="checkbox"/> 4800b/s <input checked="" type="checkbox"/> 9600 b/s <input type="checkbox"/> 19,2 kb/s <input type="checkbox"/> 38,4 kb/s <input type="checkbox"/> 57,6 kb/s <input type="checkbox"/> 115,2 kb/s	Mode <input checked="" type="checkbox"/> RTU 8N2 <input type="checkbox"/> RTU 8E1 <input type="checkbox"/> RTU 8O1 <input type="checkbox"/> RTU 8N1			
Settings	Password ****	Language <input type="checkbox"/> English <input checked="" type="checkbox"/> Polski <input type="checkbox"/> Deutsch	Back light level <input type="checkbox"/> Minimum <input type="checkbox"/> Medium <input checked="" type="checkbox"/> Maximum	Set defaults meter params <input checked="" type="checkbox"/> No <input type="checkbox"/> Yes		
Information	Type KS5	Order code 12200	Boot Version 1.04	Program Version 1.00	Serial Number 15070006	MAC Address aa.bb.cc.00:21:01

Fig. 10d. Programming matrix





7.1 Measurement

Measurement – normal meter operation. Values of quantities characterizing the state and the course of the synchronization process of the generator are displayed and signaled. The KS5 meter performs voltage measurement functions (voltage difference), frequency (frequency difference), and phase shift between the voltage signals of the network and the generator.

You can change the page by pressing the button  or .

Maximum and minimum values are displayed on a separate page. Deleting maximum or minimum values is done by pressing the button .

7.2 Parameters

In this group the parameters of the meter are set. To enter the Parameters group press the button  for about 3 seconds and then using the button  or  select Parameters and confirm with the button .

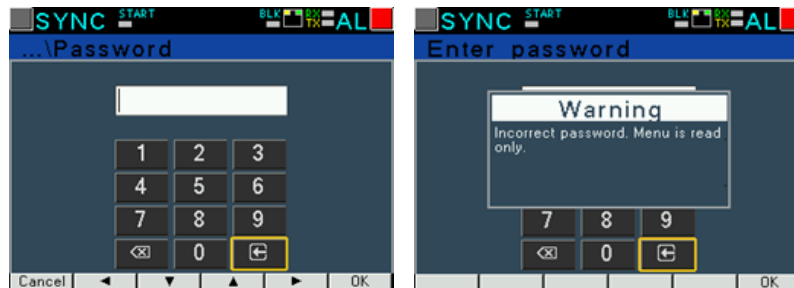

Fig. 11. Screens for entering a password

Access to configuration of parameters is protected by a password, if it has been introduced and is different from zero. When the password is 0000, the password prompt is bypassed. If the password is incorrect, the message "Invalid password. Read-only menu." is displayed. Then you can view the parameters, but the changes are blocked.

When the password is valid or not entered, we can set values according to Table 1.

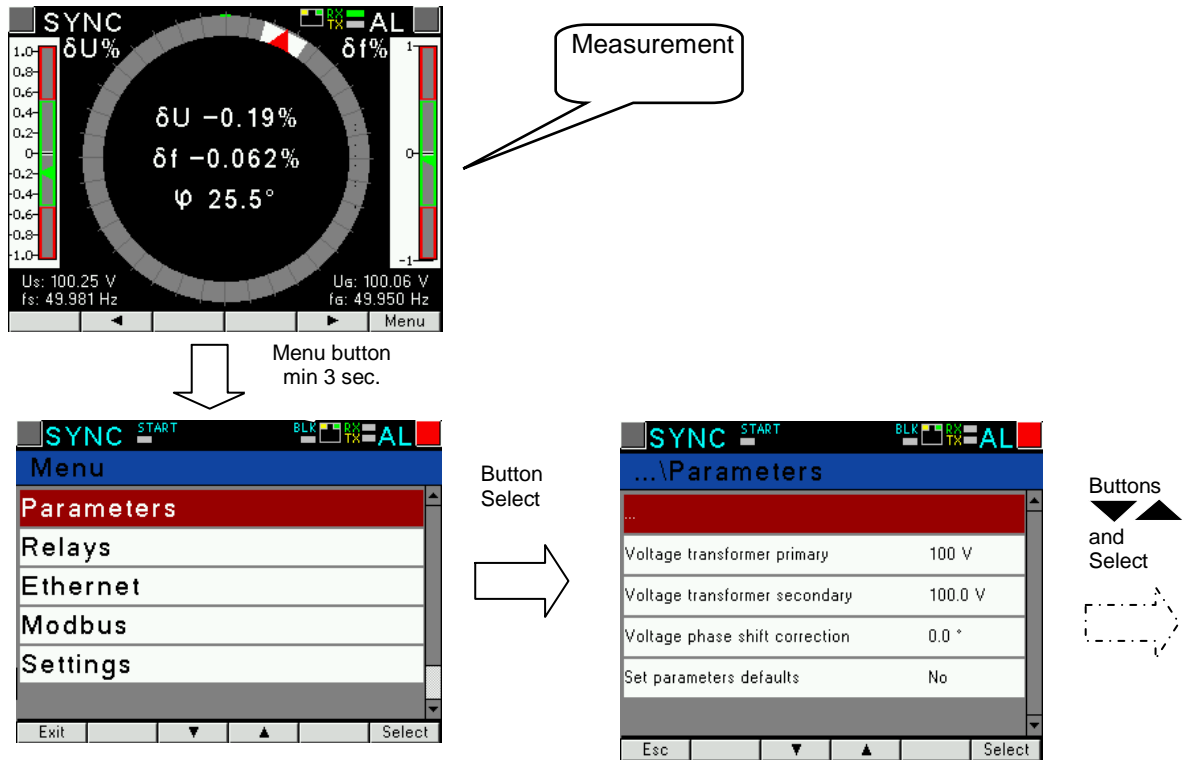
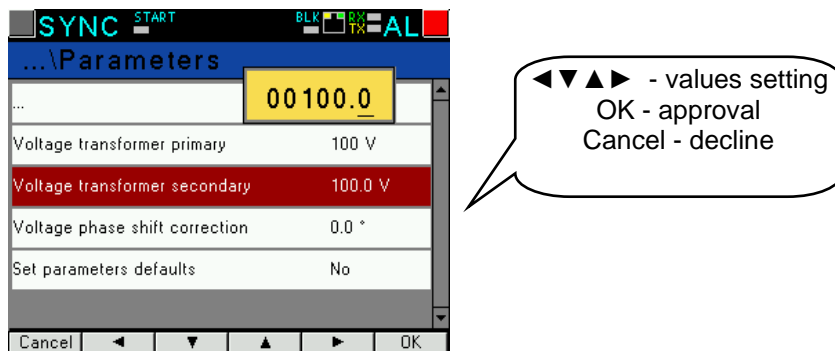

Fig.12, Screens of Parameter group

Using the buttons we select a parameter and confirm it using the button . Then using the buttons you can select the parameter characteristics or set the desired parameter values, i.e. the decimal digit position can be selected with the button or , the value of the digit with the button or . The active position is indicated by the cursor. The selected characteristic or value of the parameter should be confirmed by pressing the button or canceled by pressing the button . To exit the Parameter procedure press the button or wait for about 120 seconds. To exit the Menu of the parameter selection press the button



or wait for about 120 seconds.

Table 1

No.	Parameter name	Characteristic / value	Description	Default value
1	Primary voltage of transformer	1 .. 1245183 V		100
2	Secondary voltage of transformer	0.1 .. 1000.0		100.0
3	Compensation of fixed phase shift	-90.0° .. +90.0°		0.0°
4	Default settings of parameters	No, Yes		No

When a parameter changes, it is checked whether the value is within the range. In case of setting the value out of range, the value is set to the maximum value (when the value is too high) or to the minimum value (when the value is too low).

To configure KS5 synchronizing unit you can also use the free eCon software available at www.lumel.com.pl.

7.3 Relays

Select **Relays** in the options and confirm by pressing the button .

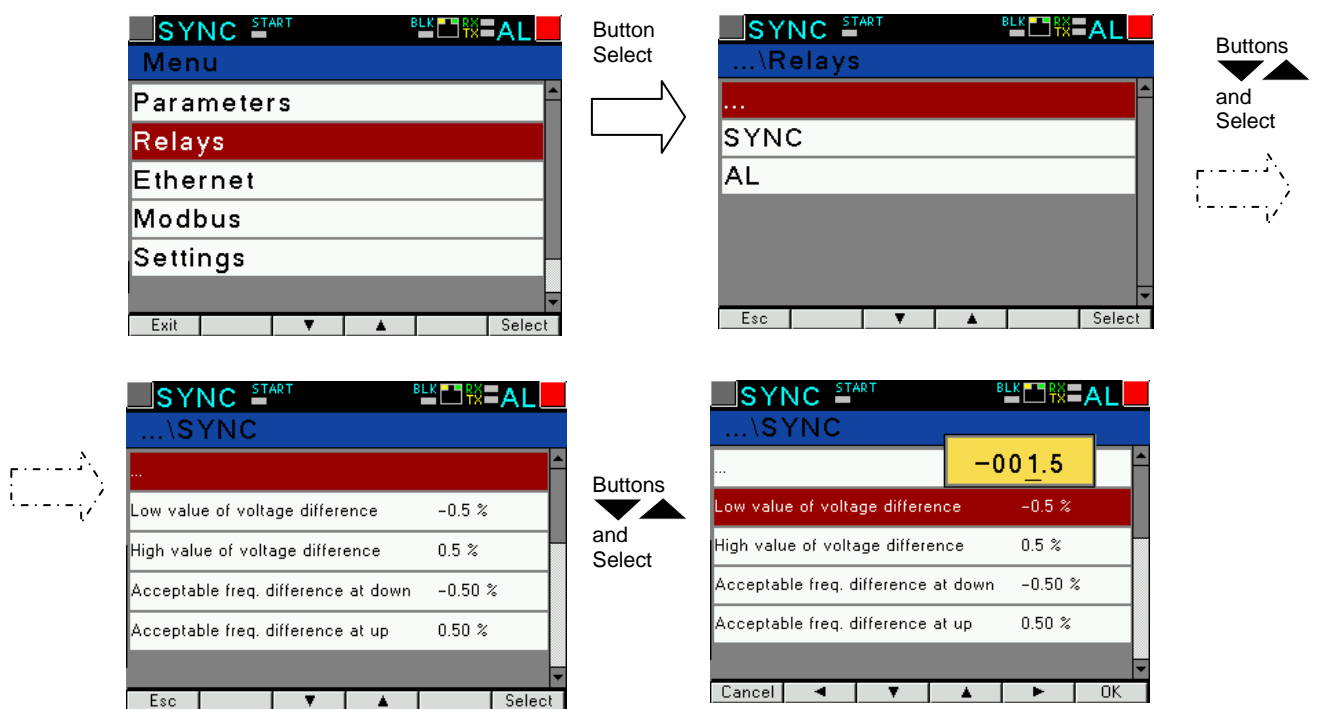
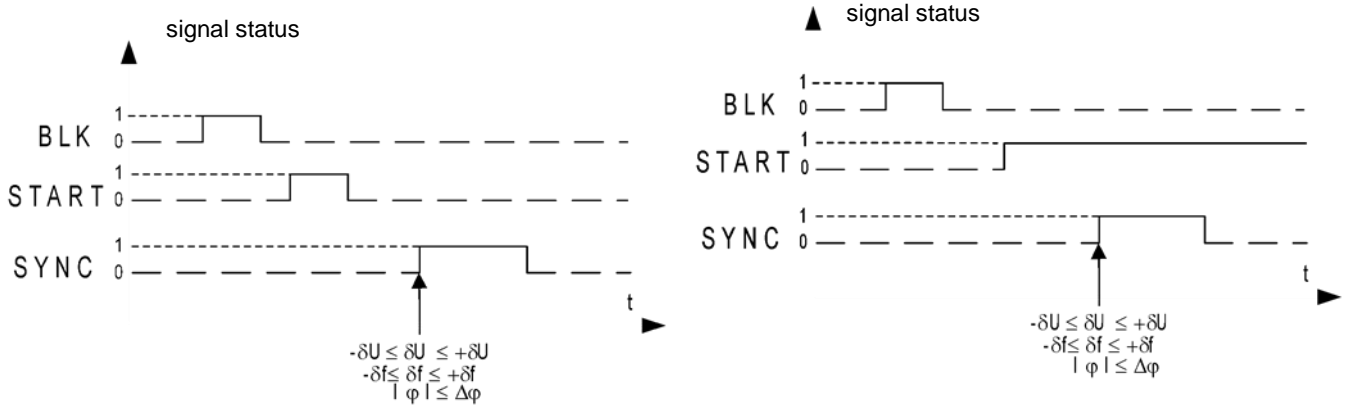

Fig.13, Screens of Relays group

Table 2

No.		Parameter name	range	Notes / description	Default value
1	SYNC relay	Low value of voltage difference $-\delta U$	-20.0 .. 0 [%]	$\delta U = 100 (U_G - U_S) / U_S$ [%]	-0.5
2		High value of voltage difference δU	0 .. 20.0 [%]		0.5
3		Acceptable freq. difference at down $-\delta f$	-3.00 .. -0.00 [%]	$\delta f = 100 (f_G - f_S) / f_S$ [%]	-0.05
4		Acceptable freq. difference at up δf	0.00 .. 3.00 [%]		0.05
5		Down switching acceptable ZL-	Yes No		Yes
6		Up switching acceptable ZL+	Yes No		Yes
7		Acceptable phase shift $\Delta\phi$	0.0..20.0 [°]		2
8		Relay lead time t_b SYNC [ms]	0..999 [ms]	t_b SYNC	0
9		Pulse mode	No Yes	permanent switching switching pulse	No
10		Width of the switching pulse [ms]	0..999 [ms]		0
11		Input signals BLK, START	Active Inactive	Graphic illustration of BLK and START input signals control with SYNC synchronization relay in Fig.14	Active
12		Set defaults	Yes No		No
13					
14	AL relay	Relative voltage difference $\delta U \geq$	20..100.0 [%]	$\delta U = 100 (U_G - U_S) / U_S $ [%]	20
15		Relative frequency difference $\delta f \geq$	10..100.0 [%]	$\delta f = 100 (f_G - f_S) / f_S $ [%]	10
16		Phase shift $\Delta\phi \geq$	20.0 .. 360.0 [°]		20
17		Set defaults	No yes		No



a,b) **SYNC** relay energized after synchronization conditions are met

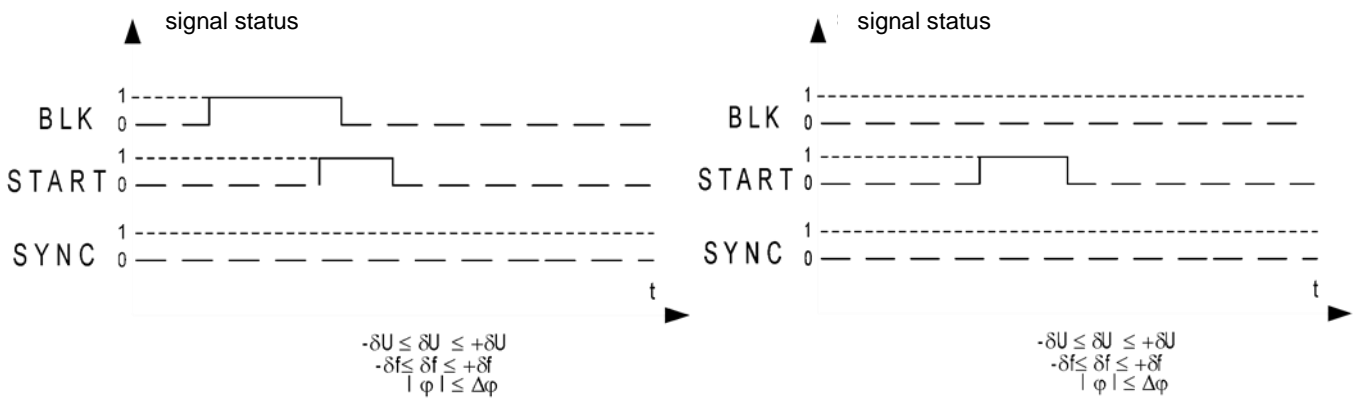

c) **SYNC** relay not energized despite meeting synchronization conditions (START signal blocked by BLK signal)

d) **SYNC** relay not energized despite meeting synchronization conditions (BLK signal did not change its status from "1" to "0")

Fig.14, Graphic illustration of BLK and START input signals control with SYNC synchronization relay

7.4 Ethernet

Select **Ethernet** group in the options and confirm selection using the button .

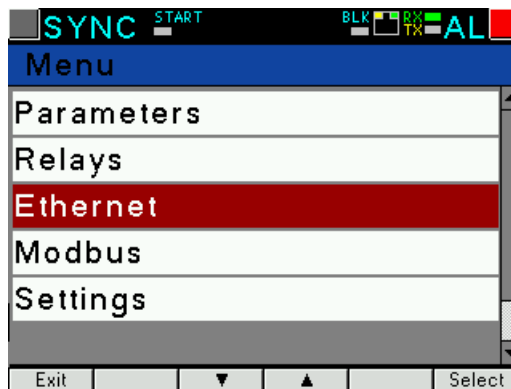

Fig.15, Ethernet mode screen

Table 3

No.		Parameter name	range	Notes / description	Default value	
1		DHCP	Deact./Act.	Enabling/disabling DHCP client (the service of automatic acquiring the parameters of Ethernet interface IP protocol of the meter from external DHCP servers located within the same LAN network).	Deact.	
2	Addresses	Mode	Auto, 10Mb/s, 100Mb/s		Auto	
3		IP Address	0.0.0.0...255.255.255.255	10.0.1.161	Acquired from DHCP or entered manually when DHCP is deactivated.	-
4		Subnet Mask	0.0.0.0...255.255.255.255	255.0.0.1		-
5		Gateway Address	0.0.0.0...255.255.255.255	0.0.0.0		-
6		DNS Address	0.0.0.0...255.255.255.255	10.0.0.44		-
7		MAC Address		Aa:bb:cc:00:21:01	-	
8	Modbus TCP	Address	1 ... 247		1	
9		Port	80 ... 32000		1	
10		Max. connection limit	1 ... 4		1	
11		Waiting time	10 .. 360		60s	
12	WWW	Port	80 ... 32000		80	

7.5 Modbus

Select **Modbus** group in the options and confirm by pressing the button .

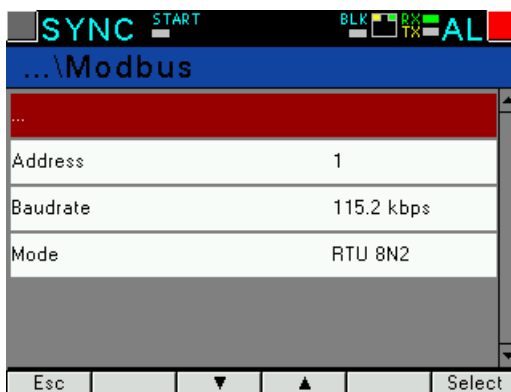

Fig.16. Screens of Modbus group

Table 4

No.	Parameter name	Characteristic / value	Description	Default value
1	Address	1...247	Address on the Modbus network.	1
2	Baudrate	4800 b/s, 9600 b/s, 19,2 kb/s, 38,4 kb/s, 57,6 kb/s, 115,2 kb/s	Baud rate	9600 b/s
3	Mode	RTU 8N2, RTU 8E1, RTU 8O1, RTU 8N1	Transmission mode	RTU 8N2

7.6 Settings

Select **Settings** group in the options and confirm by pressing the button .

Table

5

No.	Parameter name	Characteristic / value	Description	Default value
1	Password	0 ... 9999	0 – off	0
2	Language	English, Polish, Deutsch		Polish
3	Backlight level	Minimum, Medium, Maximum		Maximum
4	Set defaults meter params.	No, Yes		No

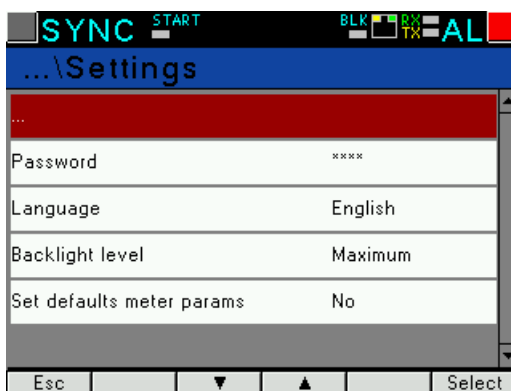

Fig.17, Screens of Settings group

7.7 Information

Select **Information** group in the options and confirm by pressing the button .

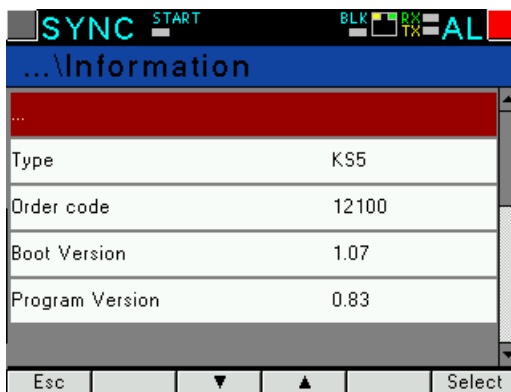

Fig.18. Screen of Information group

Table 6

No.	Parameter name	Characteristic / value	Description	Default value
1	Type		Type of synchronizing unit	KS5
2	Order code		First 5 digits of ordering code	e.g.12200
3	Boot Version		Loader version	e.g.1.04
4	Program Version		Version of the meter main program	e.g.0.60
5	Serial Number	ddmmxxxx	Current serial number of the meter day month current number	np.16070006
6	MAC Address	xx:xx:xx:xx:xx:xx	48-bit hardware address of the Ethernet interface written in hexadecimal	e.g.64:0E:0D:0C:0B:0A

8 SERIAL INTERFACES

8.1 RS485 INTERFACE – the list of parameters

The implemented protocol is in accordance with the standard PI-MBUS-300 Rev G of Modicon Company. The list of serial link parameters of KS5 meter:

- ID 0xDF
- meter address 1..247,
- baud rate 4.8, 9.6, 19.2, 38.4, 57.6, 115.2 kb/s,
- operation mode Modbus RTU,
- information unit 8N2, 8E1, 8O1, 8N1,
- maximum time to commence the response 600 ms,
- maximum number of read registers in one query
 - 61 registers – 4 byte,
 - 122 registers – 2 byte,
 - 03, 04, 06, 16, 17,
 - 03, 04 registers reading,
 - 06 one register record
 - 16 n - registers record,
 - 17 device identification
- implemented functions

Default settings: address 1, baud rate 9.6 kbit/s, RTU 8N2 mode,

8.2 Examples of registers reading and saving

Readout of n-registers (code 03h)

Example 1 . Readout of 2 16-bit registers of integer type, starting with the register addressed 0FA0h (4000) - registers values 10, 100.

Request:

Address of the device	Function	Address of the register		Number of registers		Checksum CRC
		B1	B0	B1	B0	
01	03	0F	A0	00	02	C7 3D

Response:

Address of the device	Function	Number of bytes	Value from the register 0FA0 (4000)		Value from register 0FA1 (4001)		Checksum CRC
			B1	B0	B1	B0	
01	03	04	00	0A	00	64	E4 6F

Example 2 . Readout of 2 32-bit registers of float type as a combination of 2 16-bit registers starting with the register addressed 1B58h (7000) - registers values 10, 100.

Request:

Address of the device	Function	Address of the register		Number of registers		Checksum CRC
		B1	B0	B1	B0	
01	03	1B	58	00	04	C3 3E

Response:

Address of the device	Function	Number of bytes	Value from the register 1B58 (7000)		Value from the register 1B59 (7001)		Value from the register 1B5A (7002)		Value from the register 1B5B (7003)		Checksum CRC
			B3	B2	B1	B0	B3	B2	B1	B0	
01	03	08	41	20	00	00	42	C8	00	00	E4 6F

Example 3 . Readout of 2 32-bit registers of float type as a combination of 2 16-bit registers starting with the register addressed 1770h (6000) - registers values 10, 100.

Request:

Address of the device	Function	Address of the register		Number of registers		Checksum CRC
		B1	B0	B1	B0	
01	03	17	70	00	04	4066

Response:

Address of the device	Function	Number of bytes	Value from the register 1770h(6000)		Value from the register 1770h(6000)		Value from the register 1772h(6002)		Value from the register 1772h(6002)		Checksum CRC
			B1	B0	B3	B2	B1	B0	B3	B2	
01	03	08	00	00	41	20	00	00	42	C8	E4 6F

Example 4 . Readout of 2 32-bit registers of integer type, starting with the register addressed 1D4Ch (7500) - registers values 10, 100.

Request:

Address of the device	Function	Address of the register		Number of registers		Checksum CRC
		B1	B0	B1	B0	
01	03	1D	4C	00	02	03 B0

Response:

Address of the device	Function	Number of bytes	Value from the register 1D4C (7500)				Value from register 1D4D (7501)				Checksum CRC
			B3	B2	B1	B0	B3	B2	B1	B0	
01	03	08	41	20	00	00	42	C8	00	00	E4 6F

Readout of single register (code 06h)

Example 5 . Record of 543 (0x021F) value to register 4000 (0x0FA0)

Request:

Address of the device	Function	Address of the register		Value of register		Checksum CRC
		B1	B0	B1	B0	
01	06	0F	A0	02	1F	CA 54

Response:

Address of the device	Function	Address of the register		Value of register		Checksum CRC
		B1	B0	B1	B0	
01	06	0F	A0	02	1F	CA 54

Recording to n-registers (code 10h)

Example 6. Readout of 2 registers, starting with the register addressed 0FA3h (4003)

Recording values 20, 2000.

Request:

Address of the device	Function	Address of reg.Hi	Address of reg.Lo	No. of reg. Hi	No. of reg. Lo	Number of bytes	Value for reg. 0FA3 (4003)		Value for reg. 0FA4 (4004)		Checksum CRC
							B1	B0	B1	B0	
01	10	0F	A3	00	02	04	00	14	07	D0	BB 9A

Response:

Address of the device	Function	Address of the register		Number of registers		Checksum CRC
		B1	B0	B1	B0	
01	10	0F	A3	00	02	B2 FE

Report identifying the device (code 11h)

Example 7. Device identification

Request:

Address of the device	Function	Checksum
01	11	C0 2C

Response:

Address	Function	Number of bytes	ID	Device state	Information field for device software version (e.g. "KS5-1.00 b-1.06" - KS5 device with software version 1.00 and bootloader version 1.06)	Checksum (CRC)
01	11	19	CF	FF	4E 34 33 20 2D 31 2E 30 30 20 20 20 20 20 20 20 62 2D 31 2E 30 36 20	E0 24

8.3 Ethernet 10/100-BASE-T

KS5 synchronizing units in the KS5-XX2XXXX version are equipped with Ethernet interface that allows for connection of the synchronizing unit (using RJ45 socket) to a local or global network (LAN or WAN). Ethernet interface allows to use network services implemented in the meter: web server, Modbus TCP/IP. To use the network services of the meter, you need to configure the parameters from the meter Ethernet group. Standard Ethernet parameters of the meter are shown in table 3. The basic parameter is the IP address of the meter - e.g. by default 10.0.1.161, which must be unique within the network to which we connect the device. The IP address can be assigned to the meter automatically by DHCP server present on the network provided that the option to acquire IP address from DHCP server is enabled in the meter. Ethernet → Addresses → DHCP → Enabled. If DHCP service is disabled then the meter will work with the default IP address allowing the user to change the IP address, e.g. from the meter menu. The Ethernet parameters of the meter can also be changed via the serial interface. Then the approval of changes is required by entering value "1" to the register 4149. After the changes are applied, the Ethernet interface is re-initialized according to the new parameters - all Ethernet interface services will be restarted.

8.3.1 Connection of 10/100 BASE-T interface

To access the Ethernet services, it is required to connect the meter to the network via the RJ45 slot located at the rear / inside the panel part of the meter, operating in accordance with TCP/IP protocol.

Description of RJ45 socket diodes function:

- yellow LED - illuminates when the meter is properly connected to the Ethernet network 100 Base-T, does not light up when the meter is not connected to the network or is connected to 10-Base-T network.
- green LED - Tx/Rx illuminates when the meter sends and receives data, it flickers irregularly, when no data is transmitted the diode lights up permanently

In order to connect the meter to the network the user should use twisted pair cable.

- U/FTP – twisted pair cable with each pair foiled,
- F/FTP – twisted pair cable with each pair foiled, additionally cable with foil shield,
- S/FTP (formerly SFTP) – twisted pair cable with each pair foiled, additionally cable with wire mesh shield,
- SF/FTP (formerly S-STP) – twisted pair cable with each pair foiled, additionally with foil and wire mesh shield,

Categories of twisted pair cable according to the European standard EN 50173 minimum: Class D (category 5) - for high-speed local area networks, includes applications using the frequency band up to 100 MHz. For Ethernet interface the user should use twisted pair cable of STP type (shielded) category 5 with RJ-45 connector with conductors colors (in accordance with the colors described in table 7) acc. to the following standard:

- EIA/TIA 568A for both connectors at the so-called simple connection of KS5 to the network hub or switch,
- EIA/TIA 568A for the first connector and EIA/TIA 568B for the second connector at the so-called patch cord connection (crossover) used, among others, when connecting KS5 to the computer.

Table 7

Conductor no.	Signal	Conductor color acc. to standard	
		EIA/TIA 568A	EIA/TIA 568B
1	TX+	white-green	white-orange
2	TX-	green	orange
3	RX+	white-orange	white-green
4	EPWR+	blue	blue
5	EPWR+	white-blue	white-blue
6	RX-	orange	green
7	EPWR-	white-brown	white-brown
8	EPWR-	brown	brown

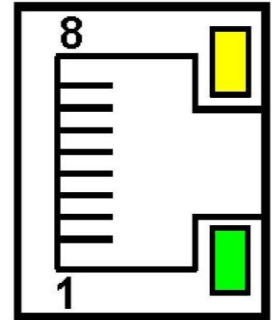

Fig.19. View and numbering of RJ45 slot pins

8.3.2 Web Server

KS5 synchronizing unit provides its own Web server that allows remote monitoring of measured values and readout of the meter status. With the web page the user can:

- obtain device information (serial number, execution code, firmware version, bootloader version, variant (standard or special)),
- preview of the current measurement values, readout of the device status,
- select the language for the Website,

The access to the Web server is achieved by entering the meter IP address in the web browser, e.g.: <http://192.168.1.030> (where 192.168.1.030 is the set address of the meter).

The standard port for web server is port "80". Server port may be changed by the user.

Caution: For proper website operation a browser with JavaScript enabled and compatible with XHTML 1.0 is required (all popular browsers, Internet Explorer, version 8 minimum).

8.3.2.1 General view

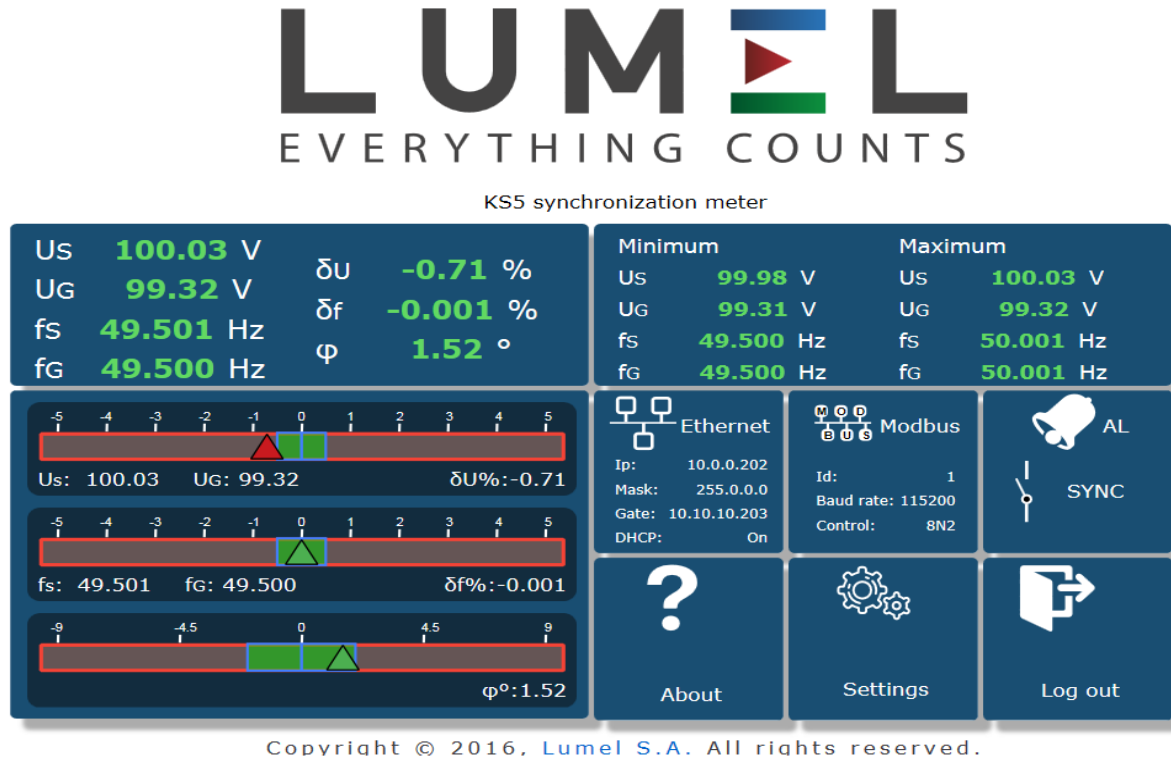

Fig. 20. View of the meter WWW page

8.3.2.2 Selection of Web Server user

The meter has two user accounts for the web server secured with an individual passwords:

- user: **"admin"**, password: **"admin"** - access to configuration and the preview of parameters
- user: **"user"**, password: **"pass"** - access to the preview of parameters only.

Calling the meter IP address in the browser, for example <http://192.168.1.30> will show the start display in the browser where the user must enter the name and password.

KS5 synchronization meter

Username

Password

Fig. 21. View of the synchronizing unit web server log window

Web server user names cannot be changed. However, it is possible to change the password for each user - it is recommended to change passwords for security reasons. Password change is only possible through the web page in "Ethernet" parameters group. Passwords can have a maximum of 8 characters. If the password is lost - which will prevent you from using the web server, you must restore the Ethernet interface parameters e.g. from the menu: Settings → Factory settings → Yes, or by entering a value of "1" in register 4152. All standard parameters of the meter including the Ethernet parameters (according to Table 9) and user passwords for WWW server will be restored:

user "admin" → password: "admin" ;

user "user" → password "pass".

8.3.3 Modbus TCP/IP

KS5 synchronizing unit allows access to internal registers via Ethernet and Modbus TCP/IP. In order to set up a connection it is necessary to set a unique IP address for the meter and to set the connection parameters listed in Table 8.

Table 8

Register	Description	Default value
4146	Device address for Modbus TCP/IP	1
4147	Port number of Modbus TCP	502
4145	Time to close the port of Modbus TCP/IP service [s]	60
4144	The maximum number of simultaneous connections to Modbus TCP/IP service	4

The device address is the device address for Modbus TCP/IP protocol and is not the same as the address value for Modbus RS485 protocol (Modbus Address 4100). By setting the "Device Address for Modbus TCP/IP Protocol" parameter to "255", the meter will skip the address analysis in the Modbus protocol frame (broadcast mode).

9 MAP OF REGISTERS OF KS5 METER

In KS5 meter the data are placed in 16- and 32-bit registers. Process variables and parameters of the meter are located in the address space of registers in a manner dependent on the type of the variable. Bits in 16-bit register are numbered from the youngest to the oldest (b0-b15). 32-bit registers contain floating point numbers in IEEE-754 standard. Byte order 3210 – the oldest is sent first.

Table 9

Address range	Value type	Description
4000 – 4053	Integer (16 bits)	Value placed in one 16-bit register. Registers for the meter configuration. Description of registers can be found in table 10. Registers for recording and reading.
4400- 4420	Integer (16 bits)	Value placed in one 16-bit register. Registers of statuses, energy values, the meter MAC address, configuration data. Description of registers can be found in table 11. Read-only registers.
6000 – 6050	Float (2x16 bits)	Values placed in two successive 16-bit registers. Registers contain the same data as 32-bit registers of 7500 – 7530 range. Read-only registers. Bytes order (1-0-3-2)
7500 – 7525	Float (32 bits)	Values placed in a single 32-bit register. Description of registers can be found in table 12. Read-only registers.
8000 - 8050	Float (2x16 bits)	Values placed in two successive 16-bit registers. Registers contain the same data as 32-bit registers of 7500 – 7525 range. Read-only registers. Bytes

		order (3-2-1-0)
--	--	-----------------

Table 10

Address of the register	Operations	Range	Description	Default
4000	RW	0...9999	Protection - password	0
4001	RW		Reserved	
4002	RW		Reserved	0
4003	RW	0..18	Primary voltage of transformer, two older bytes	0
4004	RW	0..65535	Primary voltage of transformer, two younger bytes	100
4005	RW	0..65535	Secondary voltage of transformer x 10 500...1500 V (version 1) 1500...4000 V (version 2)	1000 or 2300
4006	RW	-200 .. 0 [%o]	SYNC relay - lower limit value of voltage difference	-5
4007	RW	0 .. 200 [%o]	SYNC relay - upper limit value of voltage difference	5
4008	RW	-300 .. 0 [%/100]	Acceptable frequency difference when connecting "from below",	-5
4009	RW	0 .. 300 [%/100]	Acceptable frequency difference when connecting "from above",	5
4010	RW	-900 .. 900 [°/10]	Correction of combined voltages phase shift x 10	0.0
4011	RW	0.1	Permit to connect the generator "from below" 0 - No 1 - Yes	1
4012	RW	0.1	Permit to connect the generator "from above" 0 - No 1 - Yes	1
4013	RW	0 .. 200 [°/10]	Acceptable phase shift x 10	20
4014	RW	0 .. 999 [ms]	Lead time of SYNC relay switching	0
4015	RW	0.1	Switching pulse 0 - permanent switching 1 - switching pulse	0
4016	RW	100 .. 999 [ms]	Length of switching pulse	150
4017	RW	0.1	External lock 0 - No 1 - Yes	1
4018	RW	0.1	Deleting minimum and maximum values	0
4019	RW		Reserved	
4020	RW	200 .. 1000 [%o]	AL relay - relative voltage difference \geq	200
4021	RW	100 .. 1000 [%o]	AL relay - relative frequency difference \geq	100
4022	RW	200 .. 3600 [°/10]	AL relay - phase shift x10 \geq	200
4023	RW		Reserved	
4024	RW		Reserved	
4025	RW	1..247	Address on the Modbus network.	1
4026	RW	0..3	Transmission mode: 0->8n2, 1->8e1, 2->8o1, 3->8n1	0
4027	RW	0..5	Transmission speed: 0->4800, 1->9600 2->19200, 3->38400, 4->57600, 5->115200	1
4028	RW		Reserved	
4029	RW	0.1	Update the change of transmission parameters	0
4030	RW		Reserved	
4031	RW		Reserved	
4032	RW	0...65535	Third and second byte (B3.B2) of meter IP address, format IPv4: B3.B2.B1.B0	49320 (0xC0A8 = 192.168)
4033	RW	0...65535	First and zero byte (B1.B0) of meter IP address, format IPv4: B3.B2.B1.B0	356 (0x0164 = 1.100)
4034	RW	0...65535	Third and second byte (B3.B2) of meter subnet mask address, mask format: B3.B2.B1.B0	65535
4035	RW	0...65535	First and zero byte (B1.B0) of meter subnet mask address, mask	65280

			format: B3.B2.B1.B0	
4036	RW	0...65535	Third and second byte (B3.B2) of meter default gateway, gateway address format: B3.B2.B1.B0	49320
4037	RW	0...65535	First and zero byte (B1.B0) of meter default gateway address, format: B3.B2.B1.B0	257
4038	RW	0...65535	Third and second byte (B3.B2) of meter DNS address, format IPv4: B3.B2.B1.B0	0x0808=8.8
4039	RW	0...65535	First and zero byte (B1.B0) of meter DNS address, format IPv4: B3.B2.B1.B0	0x0808=8.8
4040	RW		Reserved	
4041	RW	0.1	Enabling/Disabling DHCP Client (service of automatic acquiring of the meter Ethernet IP parameters from External DHCP Servers within the same Local Area Network) 0 - DHCP service disabled – manually configure the IP address and subnet mask of the meter; 1 - DHCP service enabled, after powering up, or after selecting the menu option APPL, or after entering value “1” to register 4099 the meter will automatically receive the IP address, subnet mask and gateway address from the DHCP server, the gateway address will be the address of the server which assigned the meter parameters,	1
4042	RW	0 .. 2	Ethernet interface baud rate: 0 – automatic selection of baud rate 1 – 10 Mb/s 2 – 100 Mb/s	0
4043	RW		Reserved	
4044	RW		Reserved	
4045	RW	1...4	The maximum number of simultaneous connections to Modbus TCP/IP service	1
4046	RW	10...360	Time to close the port of Modbus TCP/IP service, in seconds	60
4047	RW	1...247	Device address for Modbus TCP/IP	1
4048	RW	80...32000	Port number of Modbus TCP	502
4049	RW	80...32000	Web server port number	80
4050	RW	0.1	Storing new parameters of Ethernet interface and re-initiating the interface 0 – no changes, 1 – memorizing new parameters and re-initiating Ethernet interface,	0
4051	RW	0..2	Menu language: 0-ENG, 1-PL, 2-DE	1
4052	RW	1...3	Level of brightness: 1 – Minimum, 2- Medium 3 - Maximum	3
4053	RW	0.1	Recording standard parameters (with resetting min, max) including Ethernet,	0

Table 11

Address of the register	Operations	Range	Description	Default
4400	R		Reserved	
4401	R	0..65535	Identifier	DF
4402	R	0..65535	Bootloader version x 100	-
4403	R	0..65535	Program version x100	-
4404	R		Reserved	
4405	R	0..65535	Ordering code	-
4406	R	0..65535	Nominal voltage x10	1000 or 2300
4407	R		Reserved	
4408	R		Reserved	
4409	R		Reserved	

4410	R		Reserved	
4411	R		Reserved	
4412	R		Reserved	
4413	R	0..65535	Reserved	
4414	R	0..65535	First and zero byte (B1.B0) of serial number, format B7:B6:B5:B4:B3:B2:B1:B0	-
4415	R	0..65535	Status register 1– description below	-
4416	R	0..65535	Status register 2– description below	-
4417	R		Reserved	
4418	R		Reserved	
4419	R		Reserved	
4420	R		Reserved	
4421	R	0...65535	Fifth and fourth byte (B5.B4) of meter MAC address, format B5:B4:B3:B2:B1:B0	-
4422	R	0...65535	Third and second byte (B3.B2) of meter MAC address, format B5:B4:B3:B2:B1:B0	-
4423	R	0...65535	First and zero byte (B1.B0) of meter MAC address, format B5:B4:B3:B2:B1:B0	-
4424	R		Reserved	

Device status register 1 (address 4414, R):

Bit 15 – “1” – FRAM memory corruption
 Bit 14 - "1" - no input calibration
 Bit 13 – “1” – reserved
 Bit 12 – “1” – reserved
 Bit 11 – “1” – reserved
 Bit 10 – “1” – reserved
 Bit 9 – “1” – reserved
 Bit 8 – “1” – reserved

Bit 7 – “1” – reserved
 Bit 6 – “1” – reserved
 Bit 5 – “1” – reserved
 Bit 4 – “1” – reserved
 Bit 3 – “1” – reserved
 Bit 2 - "1" - device version with Ethernet
 Bit 1 - "1" - Ethernet connection established
 Bit 0 - "1" - Ethernet cable connected

Device status register 2 (address 4415, R):

Bit 15 – “1” – SYNC
 Bit 14 – “1” – AL
 Bit 13 – “1” – reserved
 Bit 12 – “1” – reserved
 Bit 11 - "1" - generator frequency too low
 Bit 10 - "1" - generator frequency too high
 Bit 9 – “1” – START
 Bit 8 – “1” – BLK

Bit 7 – “1” – reserved
 Bit 6 - "1" - phase shift error ϕ
 Bit 5 - "1" - frequency difference error δf
 Bit 4 - "1" - voltage difference error δU
 Bit 3 - "1" - generator frequency f_G outside the range
 Bit 2 - "1" - network frequency f_S outside the range
 Bit 1 - "1" - generator voltage U_G outside the range
 Bit 0 - "1" - network voltage U_S outside the range

Table 12

Address of 16-bit registers 2x16 1032/ 2x16 3210	Address of the register 32 bits	Operations	Description	Unit
6000/8000	7500	R	Network voltage U_S	V
6002/8002	7501	R	Generator voltage U_G	V
6004/8004	7502	R	Network frequency f_S	Hz
6006/8006	7503	R	Generator frequency f_G	Hz
6008/8008	7504	R	Value of voltage difference δU	%
6010/8010	7505	R	Value of frequency difference δf	%
6012/8012	7506	R	Phase shift ϕ , range: 0..360	°
6014/8014	7507	R	Phase shift ϕ , range: -180..+180	°
6016/8016	7508	R	Reserved	
6018/8018	7509	R	Reserved	
6020/8020	7510	R	Reserved	
6022/8022	7511	R	Reserved	

6024/8024	7512	R	Reserved	
6026/8026	7513	R	Reserved	
6028/8028	7514	R	Reserved	
6030/8030	7515	R	Status register 1	-
6032/8032	7516	R	Status register 2	-
6034/8034	7517	R	Reserved	
6036/8036	7518	R	Reserved	
6038/8038	7519	R	Reserved	
6040/8040	7520	R	Voltage U_S min	V
6042/8042	7521	R	Voltage U_S max	V
6044/8044	7522	R	Voltage U_G min	V
6046/8046	7523	R	Voltage U_G max	V
6048/8048	7524	R	Frequency f_S min	Hz
6050/8050	7525	R	Frequency f_S max	Hz
6052/8052	7526	R	Frequency f_G min	Hz
6054/8054	7527	R	Frequency f_G max	Hz
6056/8056	7528	R	Value of voltage difference δU_{min}	V
6058/8058	7529	R	Value of voltage difference δU_{max}	V
6060/8060	7530	R	Value of frequency difference δf min	%
6062/8062	7531	R	Value of frequency difference δf max	%
6064/8064	7532	R	Reserved	
6066/8066	7533	R	Reserved	

10 FIRMWARE UPGRADE

KS5 meters have a feature that allows the user to upgrade the software using a PC with eCon software. Free eCon software and update files are available at www.lumel.com.pl. Software update of the meter (firmware) can be performed via RS485 interface. The update is done in LUMEL UPDATER tab.

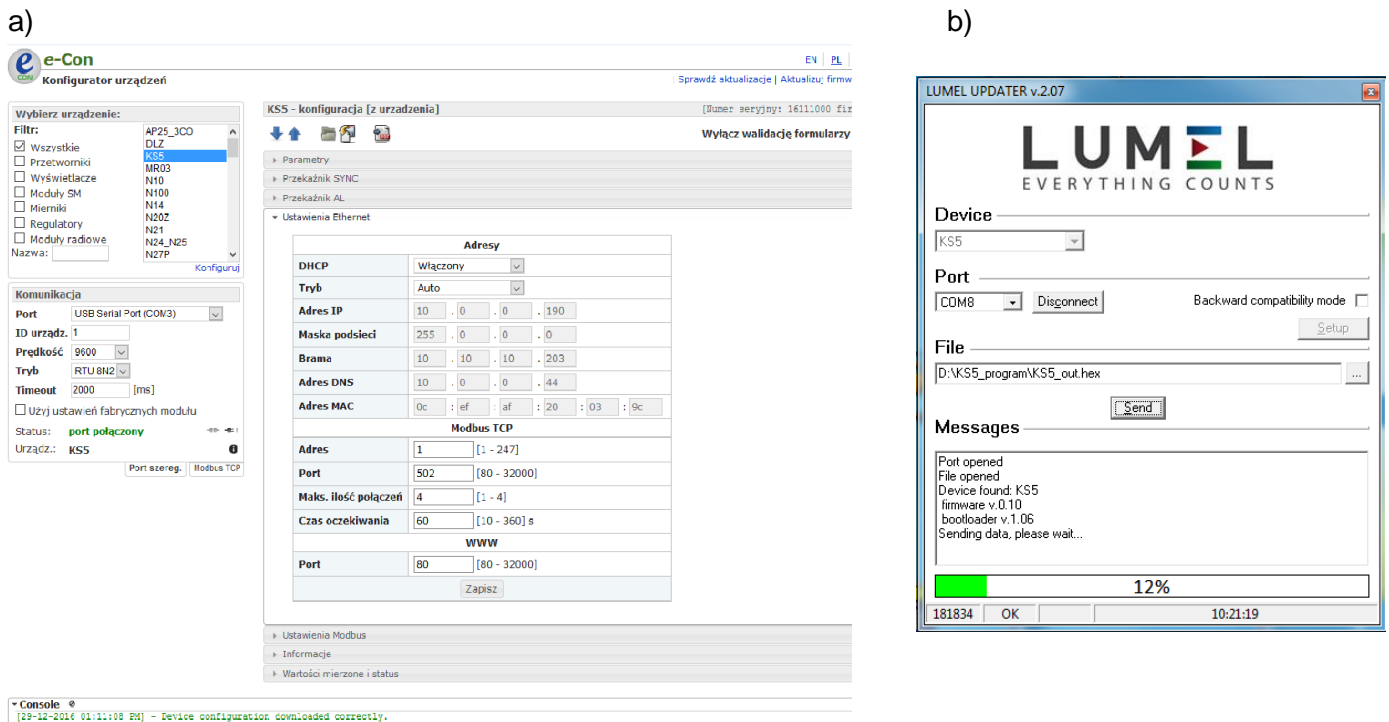



Fig.22. View of program window: a) eCon, b) firmware upgrade

Caution! After upgrading the software, the user should set the factory settings of the meter, therefore it is recommended to preserve the initial meter parameters before the upgrade with the use of eCon software.



After starting eCon the serial port, speed, mode and meter address should be set in the settings. Then select KS5 meter and click *Configure* To read all the settings, click the down arrow, then the floppy icon to save the settings to a file (to restore them later). After selecting *Update firmware* (in the upper right corner of the screen) *Lumel Updater* (LU) window will open - Fig. 22 b. Press *Connect*. *Messages* information window contains info about the progress of the upgrade process. When the port is properly opened the display shows: *Port opened*. There are two ways to enter the upgrade mode: remotely through the LU (based on settings in eCon - address, mode, speed, COM port) and by turning on the meter power by pushing the button  (when entering the bootloader mode with the button, communication parameters: speed 9600, RTU8N2, address 1). The display will show boot with bootloader version, and LU program will show the message *Device found* and the name and program version of the connected device. Press the "..." button and select the meter update file. When the file is properly opened the following message is displayed *File opened*. Press *Send* button. After successful upgrade the monitor switches to normal operation, and the information window shows *Done* and the upgrade duration. After closing the LU window, go to *Service Parameters*, select *Set Meter Defaults* and press the *Restore* button. Then press the folder icon to open the previously saved settings file and press the up arrow to save the settings in the meter. The current software version can also be checked by reading the greeting messages of the

meter after powering up.

Caution! Turning off the power during the software upgrade may result in permanent damage to the meter!

11 ERROR CODES

During operation of the meter, error messages may appear on the display. The causes of the errors are listed below.

- **Err bat** – displayed when the battery of the internal RTC clock is worn. Battery check is performed after powering. The message can be turned off with the button . Disabled message remains inactive until the sync meter is turned on again;
- **Err CAL, Err EE** – displayed when the memory in the sync meter has been damaged. The meter must be returned to the manufacturer.
- **Err PAr** – displayed when the operating parameters of the meter are incorrect. Restore the factory settings (from the menu or via RS485). The message can be turned off with the button .
- **ΛΛΛΛ** – upper overrun. The value is measured outside the measurement range.
- **VVVV** – lower overrun. The value is measured outside the measurement range.

12 TECHNICAL DATA

Measurement ranges and acceptable errors

Table 13

Measured quantity	Measurement range	Resolution	Class / intrinsic error
Voltage U_n : 50 .. 150 V~ 150 .. 400 V~	<u>20 .. 180 V</u> <u>60 .. 480 V</u> (*) ...1920 kV (tr_U≠1)	0.1 V 0.1 V 0.01 kV	0.2 (PN-EN 61557-12)
Frequency f	40..45 ..65..100 Hz	0.001 Hz	0.02 (PN-EN 61557-12)
Phase shift ϕ	<u>0..360°</u> <u>-180..+180°</u>	0.1°	±0.5°

* U_n - phase or phase-to-phase voltage (programmable in the selected range); maximum operating voltage relative to earth 300 V,

tr_U - Ratio of voltage transformer = Primary voltage of transformer / Secondary voltage of voltage transformer,

Power consumption:

- in power supply circuit ≤ 6 VA
- in voltage circuit ≤ 0.5 VA

Readout field

color graphic screen TFT 3.5" with resolution of 320 x 240 pixels

Relay outputs (AL, SYNC)

2 programmable relays, volt free NO contacts, resistive load 0.5 A/250 V a.c. or 5 A/30 V d.c.

Relay switching time 8 ms (max),

Number of switchings: mechanical minimum 5×10^6
electric minimum 1×10^5

Control inputs (BLK, START)

2 voltage inputs 20..250 V d.c./a.c.

Power consumption per input ≤ 0.25 W

RS485 serial interface

Modbus RTU 8N2,8E1,8O1,8N1. Address 1..247,

Baud rate 4.8, 9.6, 19.2, 38.4, 57.6, 115.2 kbit/s

maximum time to commence the response: 600 ms

Ethernet Interface	10/100 Base-T, RJ45 socket, Web Server, Modbus TCP/IP server, DHCP client
Sampling	A/C converter 16-bit Sampling rate 6.4 kHz for 50 Hz 7.68 kHz for 60 Hz Simultaneous sampling across all channels, 128 samples per period
Real-time clock	±20 ppm, battery of RTC CR2032

Terminals

Cross-section	0.05 .. 2.5 mm ²
Clamping screws	M3
Tightening torque	0.5 Nm

Degree of protection provided by housing

from the front side	IP 65
from the panel side	IP 20

Weight

0.3 kg

Dimensions

96 x 96 x 77 mm

Reference**conditions and rated operating conditions.**

- power supply →  85..253 V a.c. (40..50..400) Hz or 90..300 V d.c.
or 20..40 V a.c. (40..50..400) Hz or 20..60 V d.c.
- input signal: 0,4..1,2U_n
frequency 40..50 .. 60 ..100 Hz; sinusoidal (THD ≤ 8%)
- phase shift 0 .. 360° or -180..+180° for frequency f_n±5 Hz (f_n =50 or 60 Hz)
- ambient temperature -10..23..+55 °C, K55 class acc. to PN-EN61557-12
- storage temperature -20..+70 °C
- humidity 0 .. 40 ..60 ..95 % (no condensation)
- acceptable crest factor :
- voltage 2
- external magnetic field ≤ 40...400 A/m d.c.
≤ 3 A/m a.c. 50/60 Hz
- short-term overload
- voltage inputs 5 sec. 2 U_n
- operation position any
- warm-up time 15 min.

Real-time clock battery: CR2032**Additional errors:**

in % of intrinsic error

- due to ambient temperature changes < 50 % / 10 °C
- for THD > 8% < 50 %

Standards met by the synchronizing unit**Electromagnetic compatibility**

- immunity to interference in accordance with EN 61000-6-2

- noise emission acc. to EN 61000-6-4

Safety requirements:

according to PN-EN 61010-1 standard

- insulation between circuits: basic,
- installation category III for voltages up to 300V in relation to earth
- degree of pollution 2
- maximum operating voltage relative to earth
 - for power and relay outputs circuits 300 V
 - for measurement input 300 V
 - for RS485, Ethernet circuits: 50 V
- altitude < 2000m

13 ORDERING CODES

Ordering code for KS5 synchronizing unit

Table 14

Meter	KS5-	X	X	X	XX	X	X
Input voltage Un*							
50...150 V	1						
150...400 V	2						
Interfaces							
RS485	1						
RS485 and Ethernet	2						
Power supply							
85..253 V a.c., 90..300 V d.c.				1			
20..40 V a.c., 20..60 V d.c.				2			
Versions							
standard					00		
special**					XX		
Language							
Polish						P	
English						E	
other**						X	
Acceptance tests:							
without additional requirements							0
with quality inspection certificate							1
acc. to customer's requirements**							X

* Un - phase or phase-to-phase voltage (programmable in the selected range); maximum operating voltage relative to earth 300 V,

**after agreement with the manufacturer

SAMPLE ORDER, code **KS5-1 2 1 00 E 0** means:

KS5 –synchronizing unit,

1 – input voltage 50...150 V,

2 – RS485 and Ethernet,

1 – power supply voltage 85..253 V a.c., 90..300 V d.c.

00 – standard version,

E –English language version,

0 – without extra requirements.



LUMEL S.A.

ul. Sulechowska 1, 65-022 Zielona Góra, POLAND

tel.: +48 68 45 75 100, fax +48 68 45 75 508

www.lumel.com.pl

Export department:

tel.: (+48 68) 45 75 139, 45 75 233, 45 75 321, 45 75 386

fax.: (+48 68) 32 54 091

e-mail: export@lumel.com.pl