

NEW









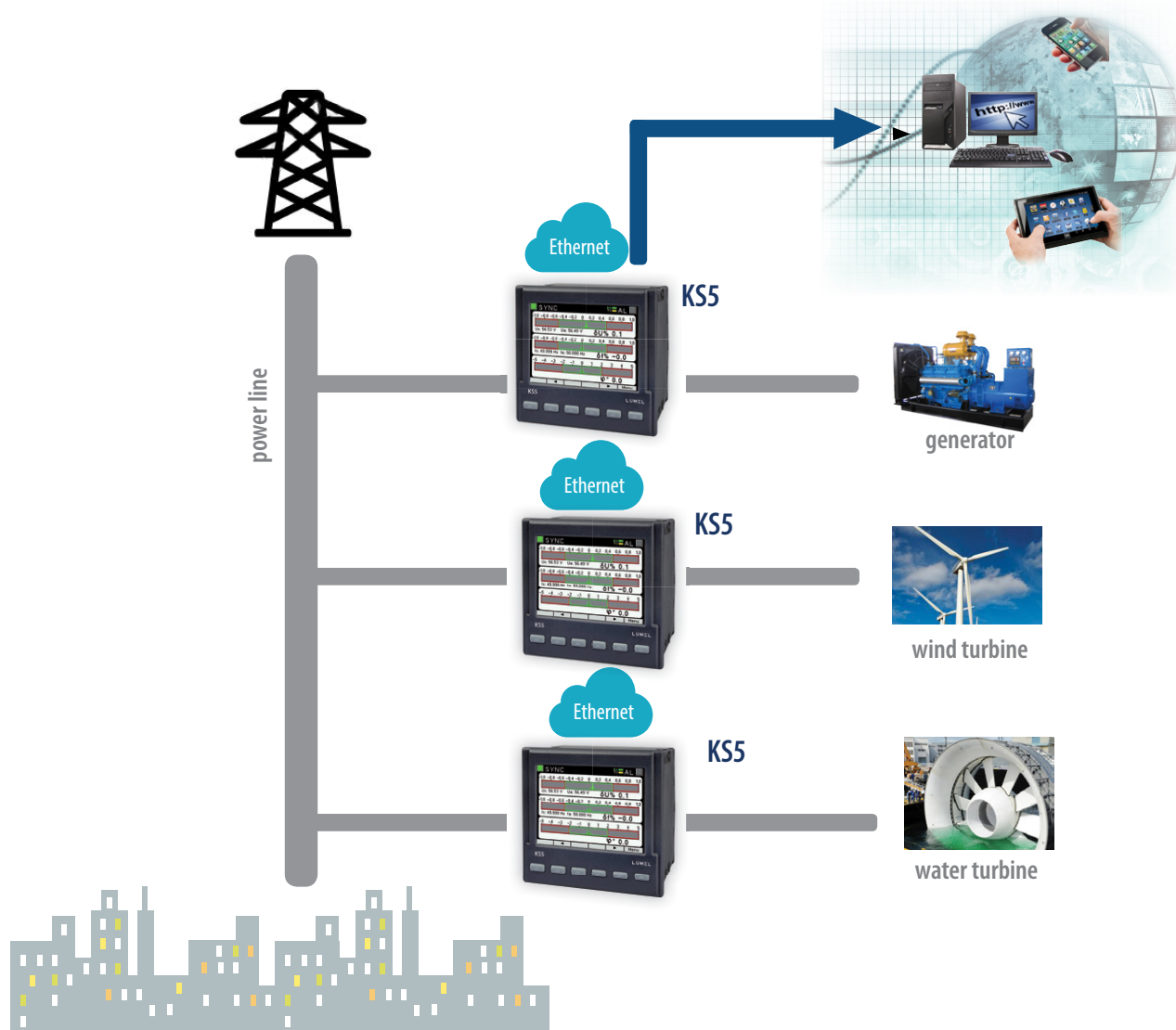

KS5 - SYNCHRONIZATION METER

- Clear data visualization thanks to color graphic display 3.5" TFT (separately for the synchroscope, differential voltmeter, frequency meter);
- Range of input signals: 50...150 V or 150...400 V;
- Direct or indirect measurement through voltage transformers;
- Additional control inputs: BLK - lock synchronization, START - start synchronization
- Programmable hysteresis of voltage difference, frequency, and phase shift angle
- **Ethernet interface 10/100 BASE-T** for connecting the synchronization meter to the local area network (LAN) or the global one (WAN);
- Network services: web server, Modbus TCP / IP, DHCP server;
- RS-485 interface with Modbus RTU protocol;
- Password protection for two accounts of Web Server user,
- Measurement of the minimum and maximum values of voltage and frequency
- External dimensions: 96 x 96 x 77mm.

EXAMPLE OF APPLICATION



FEATURES	INPUTS	OUTPUTS	GALVANIC ISOLATION
 	  	  	

TECHNICAL DATA

MEASURING RANGE

Measured value	Measuring range	Resolution	Class/ basic error
Voltage Un: 50 ... 150 V~ 150 ... 400 V~	20 ... 180 V 60 ... 480 V ... 1920 kV (tr_U≠1)	0.1 V 0.1 V 0.01 kV	0.2 (EN 61557-12)
Voltage difference ΔU	-20..0..20 %	0.1%	0.5 (EN 61557-12)
Frequency f	45 ..65 Hz	0.001 Hz	0.02 (EN 61557-12)
Frequency difference Δf	-10..0..10 %	0.01%	0.02 (EN 61557-12)
Phase shift φ	0..360°	0.1°	±0.5°

tr_U - ratio of voltage transformer = transformer primary voltage / transformer secondary voltage

INPUTS

Input type	Properties
Control inputs (BLK, START)	2 voltage input 20..250 V d.c./a.c. Power consumption per input ≤ 0.25 W

OUTPUTS

Output type	Properties
Relay outputs (AL, SYNC)	2 programmable relays, NO contacts, resistance load 0.5 A/250 V a.c. or 5 A/30 V d.c.; activation time of the relay - max. 8 ms; number of switching: mechanical - minimum 5 x 10 ⁶ , electrical - minimum 1 x 10 ⁵

DIGITAL INTERFACE

Interface type	Transmission protocol	Remarks
RS-485	Modbus RTU 8N2, 8E1, 8O1, 8N1 Adres 1..247	baud rate: 4.8, 9.6, 19.2, 38.4, 57.6, 115.2 kbit/s
Ethernet 10/100 Base-T	Modbus TCP/IP, DHCP client	RJ45 socket, WWW server

EXTERNAL FEATURES

Readout field	graphic color display LCD TFT 3,5", 320 x 240 pixels	
Overall dimensions	96 x 96 x 77 mm	mounting hole 92.5 x 92.5 mm
Weight	0.3 kg	
Protection grade	from frontal side: IP65	from terminal side: IP20

RATED OPERATING CONDITIONS

Supply voltage	→ 85..253 V a.c. (40..50..400) Hz or 90..300 V d.c. or 20..40 V a.c. (40..50..400) Hz or 20..60 V d.c.	
Power consumption	in supplying circuit ≤ 6 VA	in voltage circuit ≤ 0.5 VA
Input signal	0.2..0.4..1.2 U _n	frequency 45...50...60...65 Hz, sinusoidal (THD ≤ 8%)
Phase shift	0 .. 360° for frequency f _n ± 5 Hz (for f _n = 50 or 60 Hz)	
Preheating time	15 min.	
Ambient temperature	-10...23...55°C, class K55 acc. to EN 61557-12	
Humidity	0...40...65...95%	without condensation
Operating position	any	
External magnetic field	≤ 40...400 A/m d.c.	≤ 3 A/m a.c. 50/60 Hz
Short-term overload	voltage input: 2 U _n (5 sek.)	
Admissible crest factor	current: 2	

SAFETY AND COMPABILITY REQUIREMENTS

Electromagnetic compatibility	noise immunity	acc. to EN 61000-6-2
	noise emissions	acc. to EN 61000-6-4
Isolation insured by the casing	double	acc. to EN 61010-1
Isolation between circuits	basic	acc. to EN 61010-1
Pollution level	2	acc. to EN 61010-1
Installation category	III for phase-to-earth voltages up to 300 V	acc. to EN 61010-1
Maximal phase-to-earth voltage	<ul style="list-style-type: none"> for supplying circuits and relay outputs 300 V for measuring inputs 300 V for circuits RS-485, Ethernet: 50 V 	acc. to EN 61010-1
Altitude a.s.l.	< 2000 m	

CONNECTION DIAGRAMS

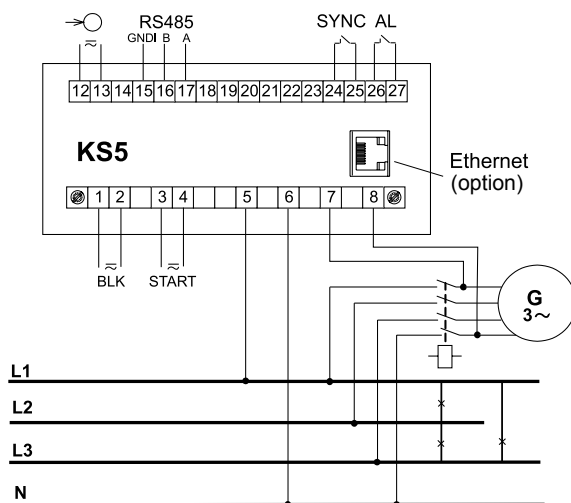

Meter connections -
measurement phase voltages

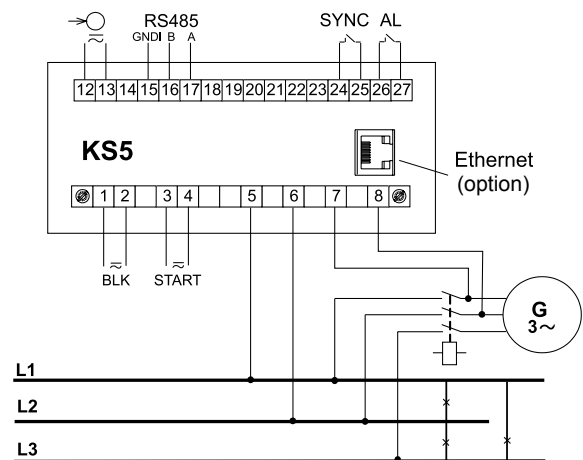

Meter connections -
measurement phase-to-phase voltages

DISPLAYING OF MEASUREMENTS PARAMETERS

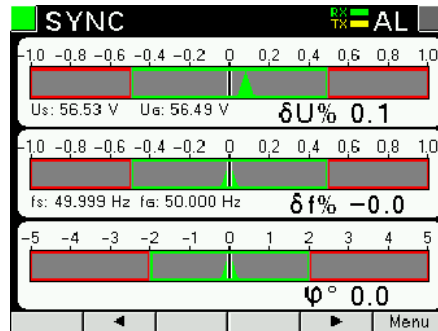
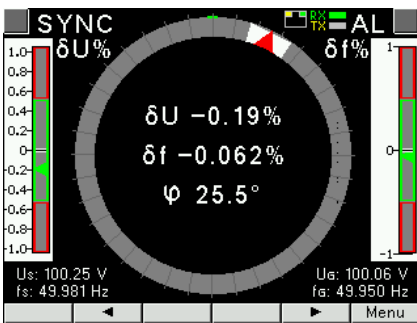

Visualization of measurement
(synchroscop, bargraphs)

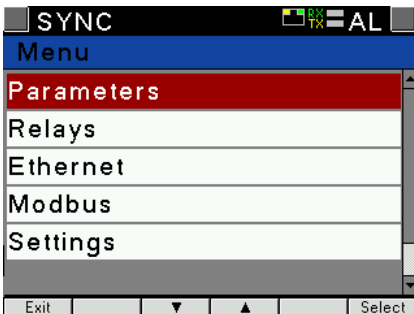

easy to use and intuitive menu

METER CONFIGURATION WITH FREE eCON SOFTWARE

eCon Device configurator

Select device: AP25_3C0, DLZ, HT20, **KS5**, MR03, N100, N14, N202, N21, N24_N25, N27P

Communication: Port USB Serial Port (COM3), Device ID 1, Baud rate 9600, Mode RTU 8N2, Timeout 1000

Status: port disconnected, Device: unknown

KS5 - configuration

Parameters

Input voltage range: 50...150 V

Primary voltage transformer: [1 - 1245183] V

Secondary voltage transformer: [1 - 1000] V

Rated frequency: 50 Hz

Brightness level: Minimum

Language: English

Password: [0 - 9999]

Restoration of factory settings:

Save

Console

[27-1-2017 02:36:41 RM] - Factory settings are not configured yet.
[27-1-2017 02:38:03 RM] - Port configuration downloaded correctly.

eCon v. 0.1.77
Copyright © 2016 Lumel S.A.
LUMEL

ability to configure and update KS5
with free eCon software
(via RS-485 or Ethernet interface)

REMOTE READOUT OF PARAMETERS THROUGH ETHERNET: WWW SERVER

LUMEL
EVERYTHING COUNTS
KS5 synchronization meter

US: 100.05 V	δU : -1.56 %	Minimum Us: 99.60 V	Maximum Us: 100.59 V
UG: 98.50 V	δf : -0.088 %	UG: 96.56 V	UG: 98.60 V
fs: 50.002 Hz	ϕ : 8.0 °	fs: 49.998 Hz	fs: 50.006 Hz
fG: 49.958 Hz		fG: 49.586 Hz	fG: 49.960 Hz

Ethernet
 Ip: 192.168.0.33
 Mask: 255.255.255.0
 Gate: 192.168.0.1
 DHCP: On

Modbus
 Id: 1
 Baud rate: 9600 b/s
 Control: 8N2

AL
 SYNC

About **Settings** **Log out**

Copyright © 2016, Lumel S.A. All rights reserved.

WEB server for remote reading of current measurement data

ORDERING CODE

	KS5 -	X	X	X	XX	X	X
Input voltage Un*:							
50...150 V		1					
150...400 V		2					
Interface:							
RS-485			1				
RS-485 and Ethernet			2				
Supply:							
85...253 V a.c., 90...300 V d.c.				1			
20...40 V a.c., 20...60 V d.c.				2			
Version:							
standard					00		
custom-made**					XX		
Language:							
Polish						P	
English						E	
other**						X	
Acceptance tests:							
without additional quality requirements							0
with an extra quality inspection certificate							1
acc.to customer's request							X

* Un - phase and phase-to-earth voltage (programmable in selected range); maximal phase-to-earth voltage 300 V,
 ** after agreeing with the manufacturer

Order example:

The code: **KS5-1 2 1 00 E 0** means:

- KS5** –synchronization meter
- 1** – input voltage 50...150 V,
- 2** – RS485 and Ethernet,
- 1** –supply 85...253 V a.c., 90...300 V d.c.
- 00** – standard version,
- E** - user's manual in English
- 0** - without additional quality requirements.

For more information about Lumel products please visit our website:
www.lumel.com.pl

Join us at Facebook!