

PMAC735 Multifunction Measuring Meter

Installation & Operation Manual

V8.2



ZHUHAI PILOT TECHNOLOGY CO., LTD.



Danger and warning!

This device can be installed only by professionals.

The manufacturer shall not be held responsible for any accident caused by the failure to comply with the instructions in this manual.



Risks of electric shocks, burning, or explosion

- This device can be installed and maintained only by qualified people.
- Before operating the device, isolate the voltage input and power supply and short-circuit the secondary windings of all current transformers.
- Put all mechanical parts, doors, or covers in their original positions before energizing the device.
- Always supply the device with the correct working voltage during its operation.

Failure to take these preventive measures could cause damage to equipment or injuries to people.

CONTENTS

1. General Information	6
1.1 Pictures of the main unit	7
1.2 Picture of the extension module	7
1.3 Type of the extension module	8
1.4 Characteristics	9
2. Installation and Connection	10
2.1 Environment	10
2.2 Dimension	10
2.3 Description of the main unit terminals.....	11
2.4 Description of extension module terminals	12
2.5 Order information.....	16
2.6 Connection.....	17
3. Measuring Capability	20
3.1 Real-time basic electrical parameters	20
3.2 Power factor symbols.....	21
3.3 Demand parameters.....	22
3.4 Energy parameters	23
3.5 Harmonic parameters (optional)	24
4. Operation	26
4.1 Display and keys	26
4.2 Data query	27
4.3 Setting.....	41

- 5. Input/output Characteristics (optional)..... 52
 - 5.1 Status input 52
 - 5.2 Relay output 53
 - 5.3 Pulse outputs..... 54
 - 5.4 Analog output 56
- 6. Alarm System (optional) 59
- 7. SOE /Event Log (optional)..... 61
- 8. Communication Protocol 62
 - 8.1 Overview 62
 - 8.2 Abnormal response..... 63
 - 8.3 Relay control 64
 - 8.4 Register reading..... 65
 - 8.5 Register setting..... 66
 - 8.6 Description of data types..... 67
 - 8.7 Calculation factors..... 67
 - 8.8 Communication values and actual values 68
 - 8.9 List of universal data registers 69
 - 8.10 List of real-time measured data registers 72
 - 8.11 List of energy data registers 75
 - 8.12 List of demand data registers 77
 - 8.13 List of harmonic data registers 80
 - 8.14 List of max./min. real time data register 81
 - 8.15 List of SOE and time registers 84
 - 8.16 List of configuration registers 85

8.17 List of energy setting registers	91
8.18 05H command control relays	92
9. Maintenance and Trouble Shooting.....	93
10. Technical Datasheet	96

1. General Information

PMAC735 is a multi-functional power meter, integrating data acquisition and control into a whole. It can take the place of numerous meters, relays, transducers, and other components. Besides, it can be used in electric power systems of various voltage classes.

PMAC735 provides one RS485 communication port, so it can be integrated into any electric power monitoring system. The management software or other configuration software with which it is equipped enables the setting to be carried out easily. Furthermore, it provides an optional PROFIBUS communication port, whose 1.5 M communication speed can fully meet the demand for obtaining real-time data on the site.

PMAC735 is really a measuring meter based on true effective values, able to carry out accurate measurement of highly non-linear loads. The complicated sampling technology enables it to measure true effective values up to the 31st harmonic. The user can read remotely some dozens of measured values and minimum/maximum values on a display screen or via software.

PMAC735 provides multiple extension modules and advanced software functions to meet the demands of different sites. Its flexible DI/DO configuration facilitates the design of the user.

PMAC735 adopts connection realized by terminals that can be pulled out and inserted, thus facilitating on-site wiring and maintenance. Especially for the parts to which current is inputted, PMAC735 uses lockable fixation connections to prevent dangers that may be caused by accidental coming off of connections.

1.1 Pictures of the main unit

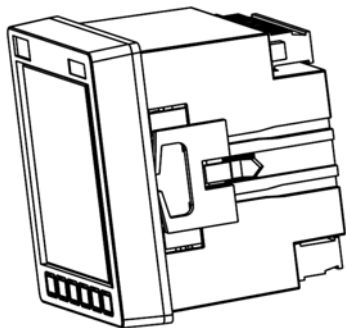

Side view

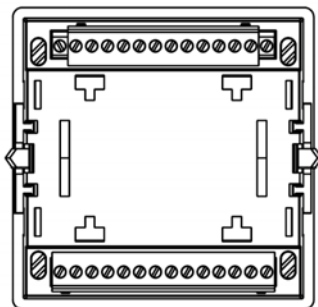

Rear view

1.2 Picture of the extension module

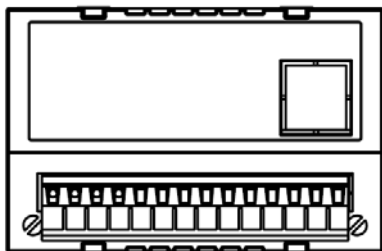

Rear view

1.3 Type of the extension module

Product Model	Description
PMAC735-A	4 status inputs and 4 relay outputs
PMAC735-B	8 status inputs and 2 relay outputs
PMAC735-E	8 status inputs and 2 pulse outputs
PMAC735-P	PROFIBUS communication port

【Notes】

1. Each PMAC735 main unit can be equipped with one extension module at most.
2. Digital input requires external dry contact.
3. The capacity of each relay output node is 250 Vac/5A or 30 Vdc/5 A.
4. For pulse output circuits, refer to the subsequent descriptions.
5. The maximum communication speed of the PROFIBUS port is 1.5 Mbps.
6. Some of the customized extension modules are not included.

1.4 Characteristics

The main parameters and characteristics of PMAC735 are as follows:

- ◆ Up to the 31st harmonic.
- ◆ Accepting standard CT and PT inputs.
- ◆ The voltage that can be directly measured is up to 500 V (phase-phase).
- ◆ Achieving the class-1 measuring accuracy stipulated by IEC 62053, with bidirectional four-quadrant energy values.
- ◆ High-accuracy measurement of current and voltage (0.1%) (typical situation).
- ◆ Measurement of THD and K factor.
- ◆ Build-in clock.
- ◆ Demand calculation and maximum recording.
- ◆ Large high-contrast LCD screen, easy for operating and setting with password lock.
- ◆ Revisable fixed value alarm and relay functions.
- ◆ RS485 communication, standard MODBUS protocol (extendible PROFIBUS port)
- ◆ Operating temperature: -20°C~+60°C.
- ◆ One optional programmable 4-20 mA analog output.
- ◆ Multiple optional extendible modules, providing flexible on-site combinations.
- ◆ Optional SOE event log.
- ◆ Standard pluggable connecting terminals, facilitating on-site installation and maintenance.
- ◆ Maximum and minimum of instant measurement.

2. Installation and Connection

2.1 Environment

1. Storage temperature: $-30^{\circ}\text{C} \sim +70^{\circ}\text{C}$
2. Operating temperature: $-20^{\circ}\text{C} \sim +60^{\circ}\text{C}$
3. Humidity: 5% ~ 90%, non-condensing

2.2 Dimension

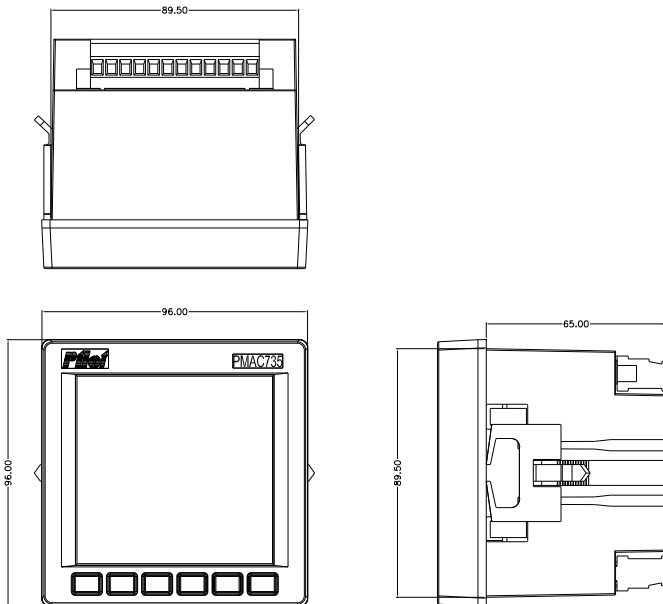

Panel size: 96.00×96.00 mm

Installation size: 89.50×89.50 mm

Depth: 65.00 mm (the depth will be increased by 25.00 mm if an extension module is added)

2.3 Description of the main unit terminals

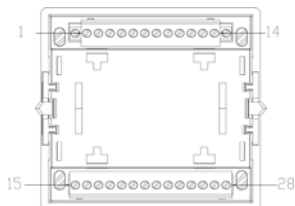

No.	Code	Definition	No.	Code	Definition
1	L/+	Positive pole of power supply	15	RS485+	Positive pole of RS485
2	NC	Null	16	RS485-	Negative pole of RS485
3	N/-	Negative pole of power supply	17	SHLD	Communication shielded earth
4	NC	Null	18	NC	Null
5	FG	Earth protection	19	NC	Null
6	NC	Null	20	A1	Positive analog output
7	\	\	21	AG	Negative analog output
8	\	\	22	VN	Voltage neutral line
9	I32	Phase C current outgoing line	23	NC	Null
10	I31	Phase C current incoming line	24	V3	Phase C voltage
11	I22	Phase B current outgoing line	25	NC	Null
12	I21	Phase B current incoming line	26	V2	Phase B voltage
13	I12	Phase A current outgoing line	27	NC	Null
14	I11	Phase A current incoming line	28	V1	Phase A voltage

2.4 Description of extension module terminals

PMAC735-A: 4 status inputs and 4 relay outputs

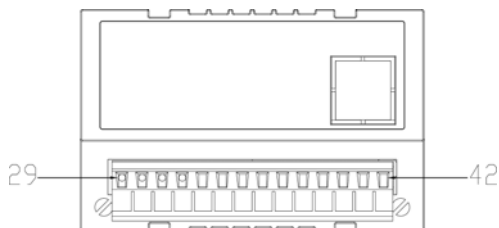

No.	Code	Definition	No.	Code	Definition
29	R42	Negative relay 4 output	36	R11	Positive relay 1 output
30	R41	Positive relay 4 output	37	Scm	Positive status 30V power supply
31	R32	Negative relay 3 output	38	S4	Status 4 input
32	R31	Positive relay 3 output	39	S3	Status 3 input
33	R22	Negative relay 2 output	40	S2	Status 2 input
34	R21	Positive relay 2 output	41	S1	Status 1 input
35	R12	Negative relay 1 output	42	NC	Null

PMAC735-B: 8 status inputs and 2 relay outputs

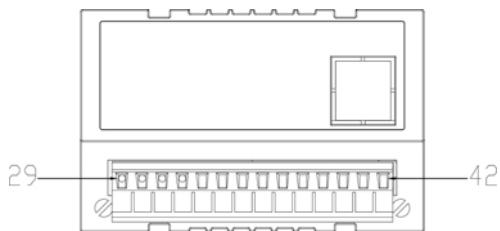

No.	Code	Definition	No.	Code	Definition
29	R22	Negative relay 2 output	36	S6	Status 6 input
30	R21	Positive relay 2 output	37	S5	Status 5 input
31	R12	Negative relay 1 output	38	S4	Status 4 input
32	R11	Positive relay 1 output	39	S3	Status 3 input
33	Scom	Positive status 30 V power supply	40	S2	Status 2 input
34	S8	Status 8 input	41	S1	Status 1 input
35	S7	Status 7 input	42	NC	Null

PMAC735-E: 8 status inputs and 2 pulse outputs

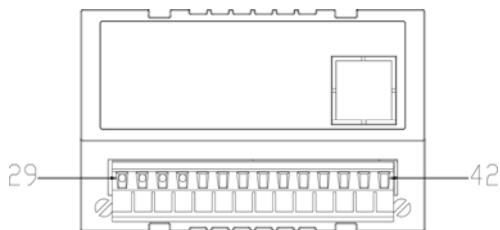

No.	Code	Definition	No.	Code	Definition
29	P2-	Negative reactive energy pulse output	36	S6	Status 6 input
30	P2+	Positive reactive energy pulse output	37	S5	Status 5 input
31	P1-	Negative active energy pulse output	38	S4	Status 4 input
32	P1+	Positive active energy pulse output	39	S3	Status 3 input
33	Scom	Positive status 30 V power supply	40	S2	Status 2 input
34	S8	Status 8 input	41	S1	Status 1 input
35	S7	Status 7 input	42	NC	Null

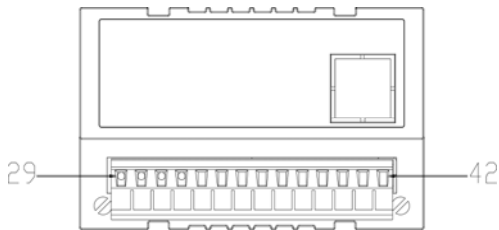

No.	Code	Definition	No.	Code	Definition
29	RB	Terminal resistor B	36	NC	Null
30	P-	Negative pole of profibus	37	NC	Null
31	P+	Positive pole of profibus	38	NC	Null
32	RA	Terminal resistor A	39	NC	Null
33	SHLD	Communication shielded earth	40	NC	Null
34	NC	Null	41	NC	Null
35	NC	Null	42	NC	Null

Remark:

There should be an resistance (150 Ohms) connected between terminal 29 and 30.

There should be an resistance (150 Ohms) connected between terminal 31 and 32.

2.5 Order information

Model: PMAC735-①-②-③-④-⑤	
Code ①:	
N	Basic module
A	4 status inputs (passive) + 4 relay outputs
B	8 status inputs (passive) + 2 relay outputs
E	8 status inputs (passive) + 2 pulse outputs
P	Profibus communication module
Code ②:	
H	Analysis of the 31 st harmonic of current and voltage, THD, K factor
T	SOE event log
AO	One 4-20 mA analog output
Code ③:	
A	AC85-265V~50Hz/60Hz DC80-300V
D	DC24 - 48V
Code ④:	
V1	Rated Voltage/Current Input: 57.7/100V, 5A
V2	Rated Voltage/Current Input: 57.7/100V, 1A
V3	Rated Voltage/Current Input: 220/380V, 5A
V4	Rated Voltage/Current Input: 220/380V, 1A
V5	Rated Voltage/Current Input: 120/ 208V, 5A
V6	Rated Voltage/Current Input: 240/ 415V, 5A
V7	Rated Voltage/Current Input: 277/ 480V, 5A
V8	Rated Voltage/Current Input: 63.5/ 110V, 5A
Code ⑤:	

50Hz	50Hz
60Hz	60Hz

Example: The ordered model is PMAC735-A-H-AO-V3.

PMAC735-A-H-AO-V3 = PMAC735 basic module+ 4 status inputs + 4 relay outputs + harmonic analysis + one 4 – 20 mA analog output + rated measurement of 220 V/380 V, 5 A.

Basic Module: Real-time measurement and energy measurement; Demand and its maximum value, max./min. recording, build-in clock.

2.6 Connection

A. Low voltage 3-phase 4-wire star connection:

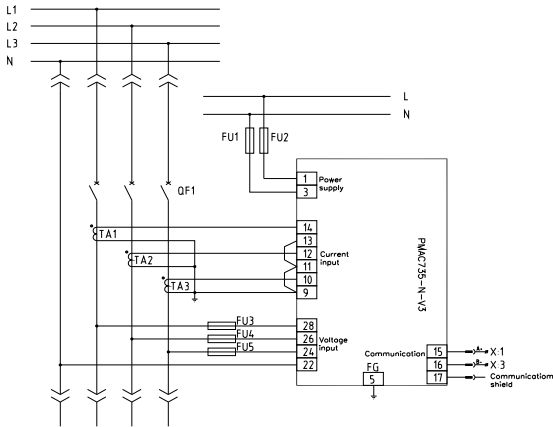

B. Low voltage 3-phase 3-wire delta connection (3 CTs):

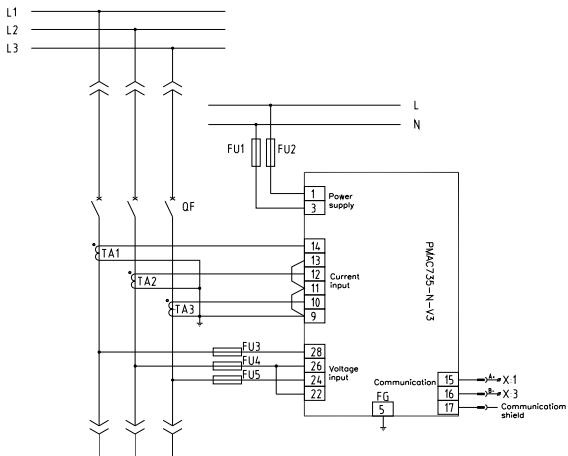

C. Low voltage 3-phase 3-wire delta connection (2 CTs):

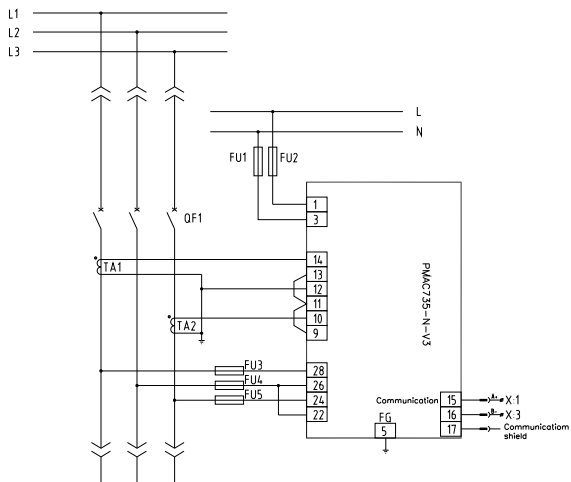

D. High voltage 3-phase 4-wire star connection:

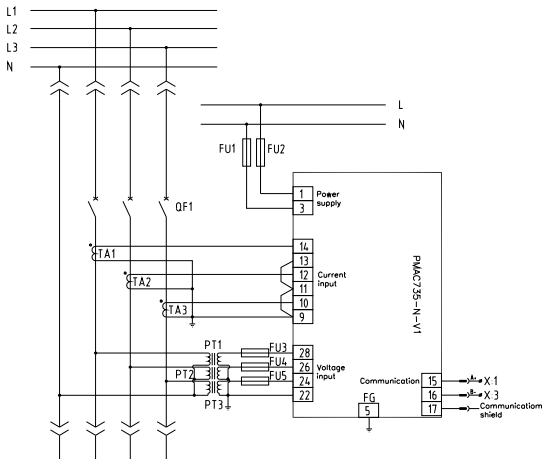

E. High voltage 3-phase 3-wire delta connection (3 CTs):

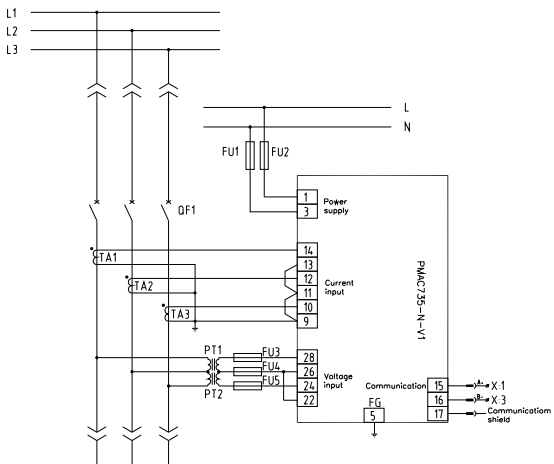

F. High voltage 3-phase 3-wire delta connection (2 CTs):

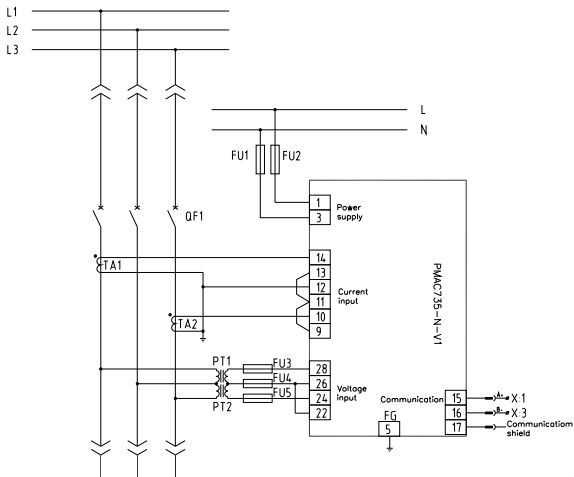

3. Measuring Capability

3.1 Real-time basic electrical parameters

PMAC735 provides voltage, current, power, and frequency etc. basic parameters. The following data are effective real values, and the refresh rate is 1 second.

Real-time reading	Measuring range
Current	
Each phase	0 – 50,000 A
Zero sequence	0 – 50,000 A
Degree of unbalance (%)	0 – 100%
Voltage	
Line-line	0 – 500 kV

Line-neutral line	0 – 500 kV
Degree of unbalance (%)	0 – 100%
Active power/Reactive power /Apparent power	
Single phase	0 - ± 100 MW/Var/VA
Total	0 - ± 100 MW/Var/VA
Power factor	
Single phase	-1.000 – +1.000
Total	-1.000 – +1.000
Frequency	
35 – 65 Hz	35 – 65 Hz

3.2 Power factor symbols

The symbols of measuring power factor conform to the stipulations of IEC, and the figure below describes the relevant definitions.

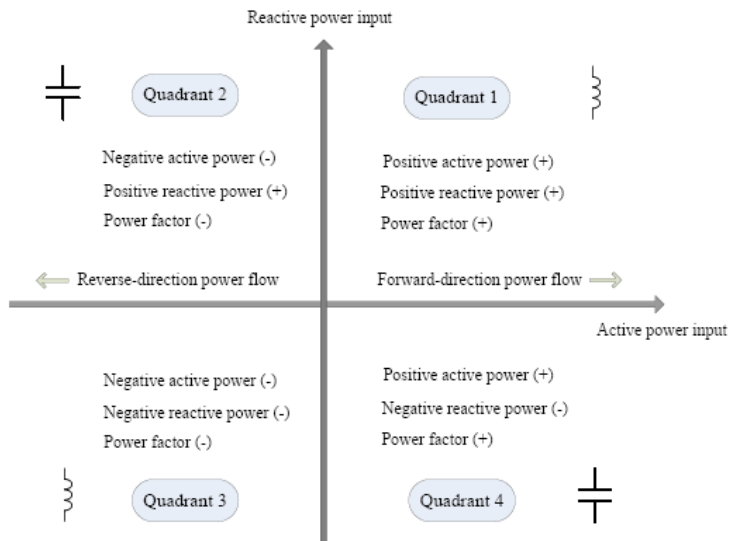

3.3 Demand parameters

Demand refers to the value obtained in the following way: the accumulated electrical parameters within a period of time divided by the time length. To facilitate the operation of the user, PMAC735 adopts the fixed-block calculation method in the fixed period of time, and the period of time is fixed, being 15 minutes.

PMAC735 provides the following demand data and measuring ranges:

Demand reading	Measuring range
Demand current	
Three-phase average value	0 – 50,000 A

Maximum peak	0 – 50,000 A
Active power/Reactive power /Apparent power	
Three-phase total	0 - ± 100MW/Var/VA
Maximum peak	0 - ± 100MW/Var/VA

The figure below describes demand calculation:

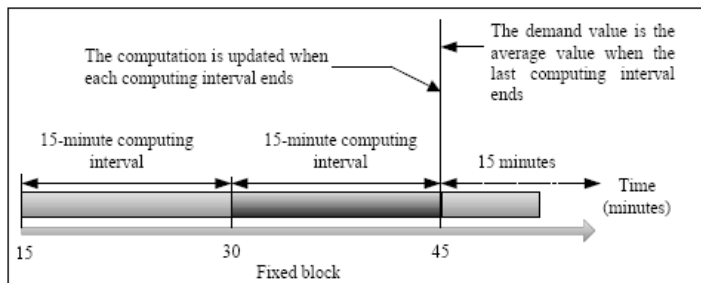

3.4 Energy parameters

PMAC735 can measure bidirectional four-quadrant active and reactive energy, and the maximum accumulated value is up to 99,999,999.9. The decimal place will not show. When the accumulated value reaches to maximum, it will overturn automatically.

The polarity of energy is identical to that of power, both conforming to the stipulations of IEC standards. For the relevant definitions, please refer to the descriptions of *3.2 Power factor symbol*.

The table below describes the interrelationships of various types of energy and the symbolic relationships between energy and power:

Active energy input

First-quadrant active energy

Positive inductive active power

	Fourth-quadrant active energy	Positive capacitive active power
Active energy output	Second-quadrant active energy	Negative capacitive active power
	Third-quadrant active energy	Negative inductive active power
Reactive energy input	First-quadrant reactive energy	Positive inductive reactive power
	Second-quadrant reactive energy	Positive capacitive reactive power
Reactive energy output	Third-quadrant reactive energy	Negative inductive reactive power
	Fourth-quadrant reactive energy	Negative capacitive reactive power

3.5 Harmonic parameters (optional)

PMAC735 provides optional measurement of complete 31st harmonic for voltage and current as well as their total harmonic content (THD) and K factor of current.

The data of harmonics are given according to the percentage of fundamental harmonics and have one digit after the decimal point. That is to say, when the value of the fundamental harmonic is fixed at 1000, it is 100.0% of the effective value of the fundamental harmonic; others are by analogy.

THD refers to the total of higher harmonics except fundamental harmonics, and it is calculated according to the following formula:

$$THD = \sqrt{\sum_{i=2}^{i=n} X_i^2}$$

The formula for calculating K factor is as follows:

$$K = \sqrt{\sum_{i=1}^{i=n} (i \times X_i)^2 / \sum_{i=1}^{i=n} X_i^2}$$

i : Harmonic order.

X_i : Percentage of the effective value of each harmonic to that of the fundamental harmonic.

N : Highest harmonic order, which should be 31 here.

【Attention】

1. Each harmonic and THD can be checked through display or communication.
2. K factor can be checked only through communication.

4. Operation

4.1 Display and keys





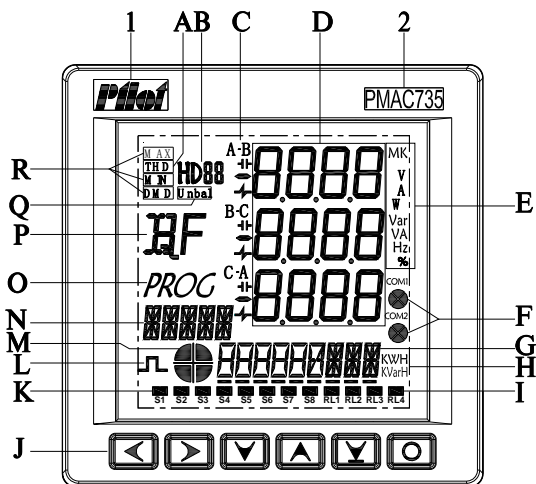

Display instruction

- A: THD prompt
- B: Higher harmonic prompt
- C: Phase sequence & quadrant prompt
- D: Real-time data display area
- E: Real-time data unit
- F: Communication prompt
- G: Energy/programming data area
- H: Energy unit
- I: Relay status indication
- K: Status state indication
- L: Energy pulse function prompt
- M: Energy quadrant prompt
- O: Programming indication
- P: Real-time data type indication
- Q: Unbalance rate prompt
- R: Minimum/maximum value/demand prompt

1: Trademark of the Company



2: Product type





Key-press instruction: function of each key vary with interface			
	Display interface of measured data	Programming interface	
		Enquiry configuration	Modification configuration
	Submenu page-up	\	Move the cursor left
	Submenu page-down	\	Move the cursor right
	Main menu page-down	Menu turning-down	Decrease the numeric value at the cursor
	Main menu page-up	Menu turning-up	Increase the numeric value at the cursor
	Energy page turning	Press the key “Enter” to enter into modification	Press the key “Enter” to confirm the modification
	Enter into programming interface	Exit from programming interface	Exit from programming interface



4.2 Data query



The real-time measured data are indicated in the form of main menu and submenu.

Keys for main menu page turning:  

Keys for submenu page turning:  

Menu tree diagram:

For main menu page turning, press  and .

For page turning of the submenus under each main menu, press  and .

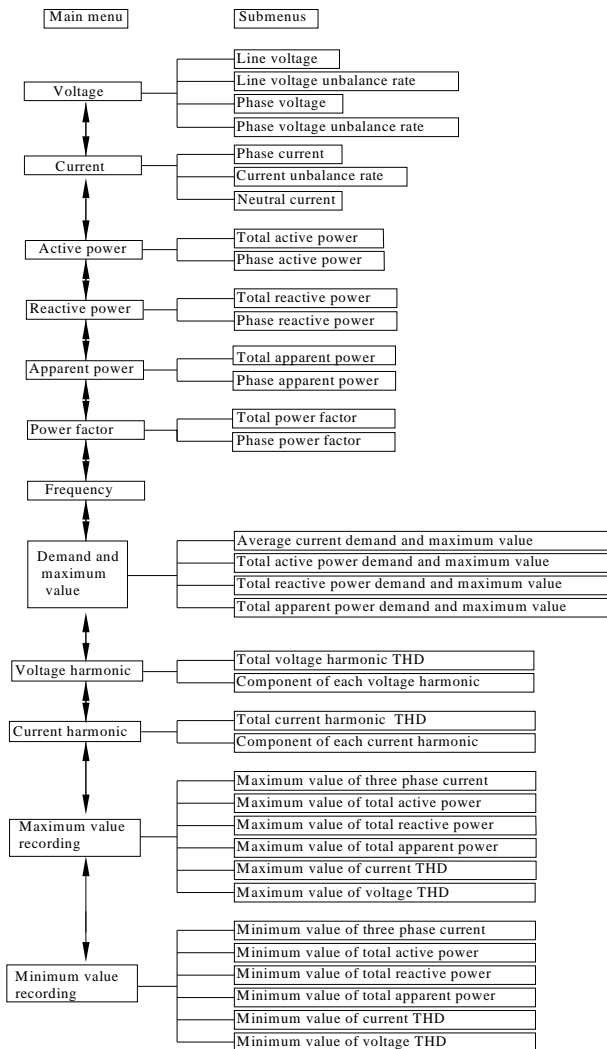

The procedure of real-time data query is as follows:

The initial power-up interface of the meter is shown as follows:

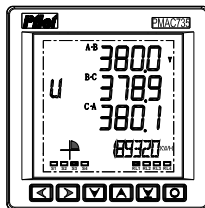

4.2.1 Voltage data query

Press the key  continuously, and you will see the following items one by one:

a. Line voltage

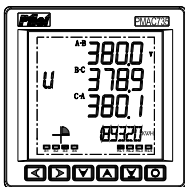

c. Phase voltage



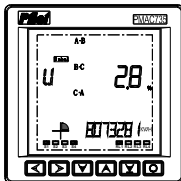

b. Line voltage unbalance rate



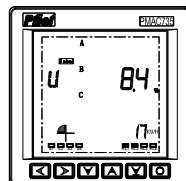

d. Phase voltage unbalance rate





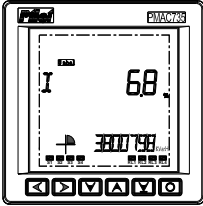

4.2.2 Current data query

1. Press the key  once, and you will see the current data.
2. Press the key  continuously, and you will see the following items one by one:

a. Three phase current	b. Current unbalance rate	c. Neutral current
		

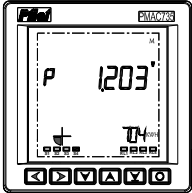
4.2.3. Active power data query

<ol style="list-style-type: none">1. Press the key  once, and you will see total three phase active power.	<ol style="list-style-type: none">2. Press the key  continuously, and you will see the single-phase active power.
	

4.2.4. Reactive power data query

1. Press the key  once, and you will see the total three phase reactive power

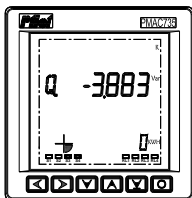



2. Press the key  continuously, and you will see the single-phase reactive power

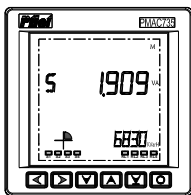

4.2.5. Apparent power data query

1. Press the key  once, and you will see the total three phase apparent power



2. Press the key  continuously, and you will see the single-phase apparent power

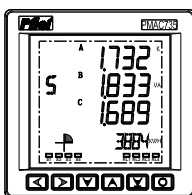

4.2.6. Power factor query

1. Press the key  once, and you will see the total three phase power factor



2. Press the key  continuously, and you will see the single-phase power factor





4.2.7. Frequency

Press the key  once, and you will see the frequency data.



4.2.8. Demand and maximum value query

1. Press the key  once, and you will see the demand parameters.
2. Press the key  continuously, and you will see the following items one by one:

Note: The time record of maximum demand is displayed as below format:

1st row: year, month

2nd row: day, hour

3rd row: minute, second

a. Current demand and maximum value

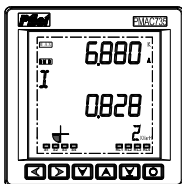

c. Active power demand and maximum value

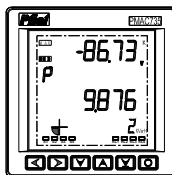

b. Time record of maximum current demand



d. Time record of maximum active power demand

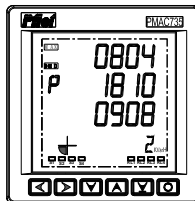

e. Reactive power demand and maximum value



f. Time record of maximum reactive power demand

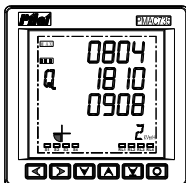

g. Apparent power demand and maximum value



h. Time record of maximum apparent power demand

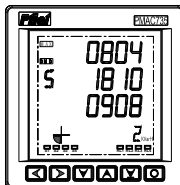

4.2.9. Voltage harmonic query

1. Press the key  once, and you will see the voltage harmonics.

THD value

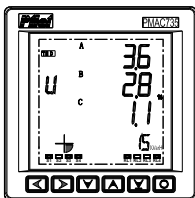

2. Press the key  continuously, and you will see the component of each harmonic (take the component of the 18th harmonic as an example)

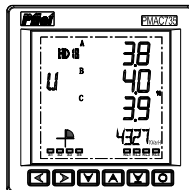

4.2.10. Current harmonic query

1. Press the key  once, and you will be able to see the current harmonics.

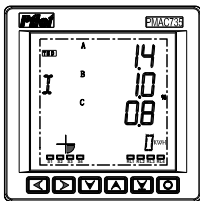

THD value

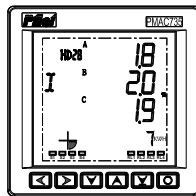

2. Press the key  continuously, and you will see the component of each harmonic (take the component of the 28th harmonic as an example)



4.2.11. Maximum value recording

1. Press the key  once, and you will see the Maximum value of real time data
2. Press the key  continuously, and you will see the following items one by one:

a. Maximum value of three phase current



b. Maximum value of total active power

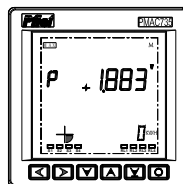

c. Maximum value of total reactive power

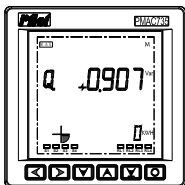

d. Maximum value of total apparent power





e. Maximum value of current THD

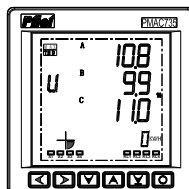

f. Maximum value of voltage THD



4.2.12. Minimum value recording

1. Press the key  once, and you will see the minimum value of real time data.
2. Press the key  continuously, and you will see the following items one by one:

a. Minimum value of three phase current

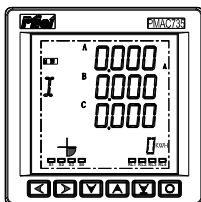

b. Minimum value of total active power

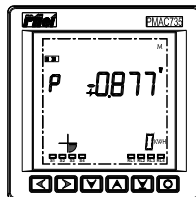

c. Minimum value of reactive power

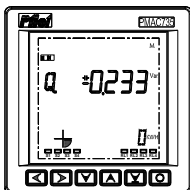

d. Minimum value of total apparent power

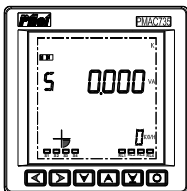

e. Minimum value of current THD

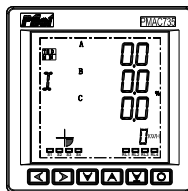

f. Minimum value of voltage THD

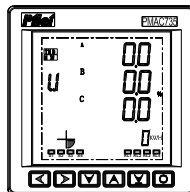

4.2.13. Energy data query:

In any query interface, press the key  continuously, and you will see the following items one by one:

a. First-quadrant active energy

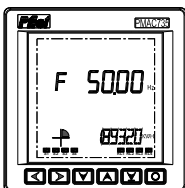

b. Second-quadrant active energy

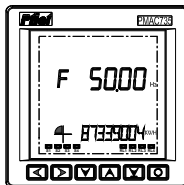

c. Third-quadrant active energy

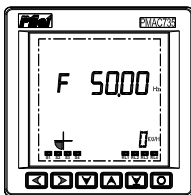

d. Fourth-quadrant active energy

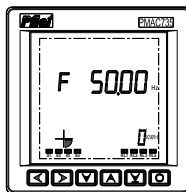

e. First-quadrant reactive energy

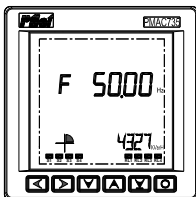

f. Second-quadrant reactive energy

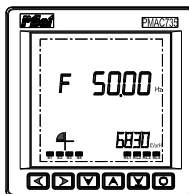

g. Third-quadrant reactive energy

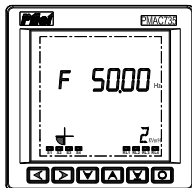

h. Fourth-quadrant reactive energy

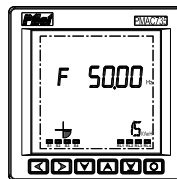

i. Active energy input

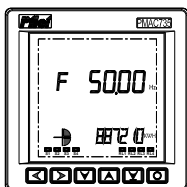

j. Active energy output

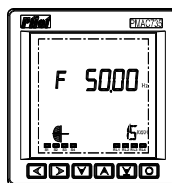

k. Reactive energy input

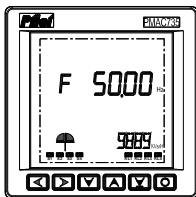

l. Reactive energy output

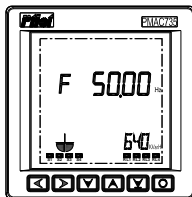

If the meter has the clock function, then, in any query interface, press the key  continuously, you will see the following items after the energy one by one:

Year, month, and day

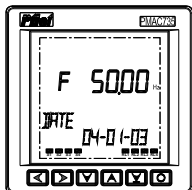

Hour, minute, and second

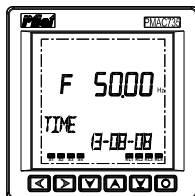

In any query interface, press the key  continuously and you will see the correlative diagnostic message of meter:

Diagnostic message

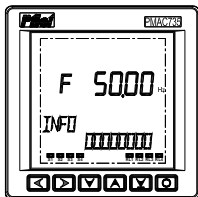

Diagnostic explanation:

0 means no fault, 1 means has fault.

The first four digits are reserved.

The fifth digit: diagnosis of sampling reference point.

The sixth digit: diagnosis of configuration parameter.

The seventh digit: diagnosis of accuracy coefficient.

The eighth digit: diagnostic message of external storage.

【Notes】

1. All the values concerned are assumed for explanation, and they maybe not comply with logical relationship.
2. The real-time data concerned when query about energy data are assumed only for explanation.





4.3 Setting

The setting procedure is as follow:

1. Press the key  to display PROG.

Enter the correct password (the default password is 1).

■ CT primary side setting

1. Press the key  until CT-PR appears;
2. Press the key , and the cursor appears;
3. Press the key  to modify the value;
4. Press the key  to confirm the new value, and the cursor disappears.

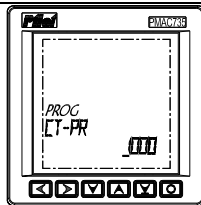

CT primary side can be set 49,999 maximum.



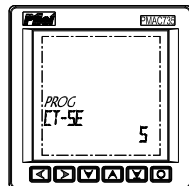

■ CT secondary side setting

Press the key  until CT-SE appears;
Hardware factor cannot be set, just for read only.



5 or 1 is fixed as CT secondary side



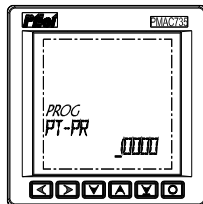

■PT primary side setting

1. Press the key  until PT-PR appears;
2. Press the key , and the cursor appears;
3. Press the key  to modify the value;
4. Press the key  to confirm the new value, and the cursor disappears.



PT primary side can be set 500,000 maximum



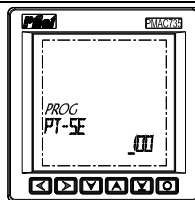

■PT secondary setting

1. Press the key  until PT-SE appears;
2. Press the key , and the cursor appears;
3. Press the key  to modify the value;
4. Press the key  to confirm the new value, and the cursor disappears.





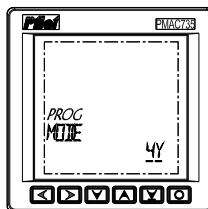

PT secondary side can be set 200 maximum

■Measuring mode setting

1. Press the key  until MODE appears;
2. Press the key , and the cursor appears;
3. Press the key  to select 4-wire star connection (4Y) or 3-phase delta connection (3D);
4. Press the key  to confirm the selection, and the cursor disappears.





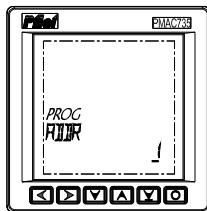

■ Communication address setting

1. Press the key  until ADDR appears;
2. Press the key , and the cursor appears;
3. Press the key  to modify the value;
4. Press the key  to confirm the new value, and the cursor disappears.





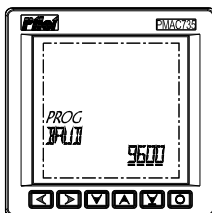

■ Communication baud rate setting

1. Press the key  until BAUD appears;
2. Press the key , and the cursor appears;
3. Press the key  to select 4800, 9600, 19200, or 38400;
4. Press the key  to confirm the selection, and the cursor disappears.





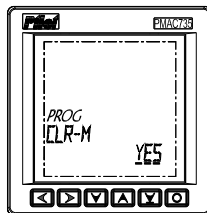

■ The max. /min. of real time data clearance

1. Press the key  until CLR-M appears;
2. Press the key , and the cursor appears;
3. Press the key  to select YES or NO;
4. Press the key  to confirm the selection, and the cursor disappears (YES means executing clearance).





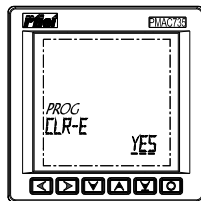

■ Energy data clearance

1. Press the key  until CLR-E appears;
2. Press the key , and the cursor appears;
3. Press the key  to select YES or NO;
4. Press the key  to confirm the selection, and the cursor disappears (YES means executing clearance).





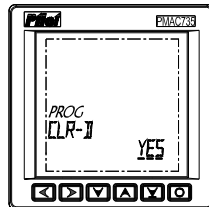

■ Demand data clearance

(Including maximum value of demand)

1. Press the key  until CLR-D appears;
2. Press the key , and the cursor appears;
3. Press the key  to select YES or NO;
4. Press the key  to confirm the selection, and the cursor disappears (YES means executing clearance).





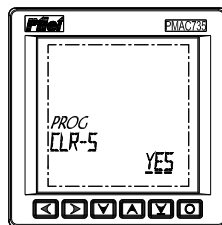

■ Data record clearance

1. Press the key  until CLR-S appears;
2. Press the key , and the cursor appears;
3. Press the key  to select YES or NO;
4. Press the key  to confirm the selection, and the cursor disappears (YES means executing clearance).





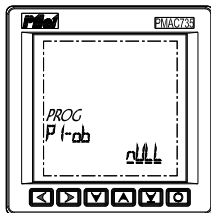

If the meter is equipped with energy pulse (i.e. PMAC735E-), you will be able to look up the relevant object of pulse output and pulse constant.

■ Object of active energy pulse output

1. Press the key  until P1-ob appears;
2. Press the key , and the cursor appears;
3. Press the key  to select nULL or IMP or EXP;
4. Press the key  to confirm the selection, and the cursor disappears.





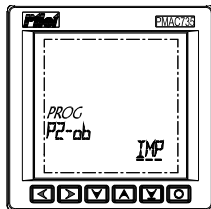

■ Object of reactive energy pulse output

1. Press the key  until P2-ob appears;
2. Press the key , and the cursor appears;
3. Press the key  to select nULL or IMP or EXP;
4. Press the key  to confirm the selection, and the cursor disappears.



■ Pulse output constant

1. Press the key  until P-NUM appears;
2. Press the key , and the cursor appears;
3. Press the key  to modify value;
4. Press the key  to confirm new value, and the cursor disappears.

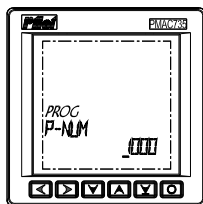





Note:

1. P1-ob refers to the setting for object of active energy pulse output.
2. P2-ob refers to the setting for object of reactive energy pulse output.
3. nULL: disable; IMP: import quantity; EXP: export quantity.
4. P-NUM refers to the setting pulse constant.

If the meter is equipped with analog output (i.e. PMAC735--AO--), you will be able to look up the relevant object of analog output and multiple of analog output.



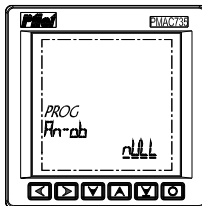

■ Object of analog output

1. Press the key  until An-ob appears;
2. Press the key , and the cursor appears;
3. Press the key  to select nULL or others;
4. Press the key  to confirm the selection, and the cursor disappears.

Note: After re-set the object of analog output, please re-start the device (PMAC735).



■ Multiple of analog output

1. Press the key  until An-MU appears;
2. Press the key , and the cursor appears;
3. Press the key  to modify value;
4. Press the key  to confirm new value, and the cursor disappears.

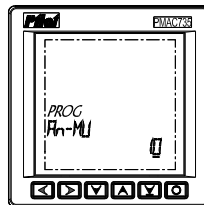

Note:

1. nULL: disable;

U1: Phase A voltage; U2: Phase B voltage; U3: Phase C voltage;

U12: Line AB voltage;

U23: Line BC voltage;

U31: Line CA voltage;





I1: Phase A current ; I2: Phase B current; I3: Phase C current ;

P: Total active power; q: Total reactive power; PF: Total power factor; F: Frequency;

2. In multiple setting, there is one digit of decimal with the displayed data and it is the last digit.



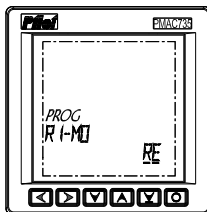

If the meter is equipped with relays (i.e. PMAC735A-/B-), you will be able to look up the mode and return time value of each relay.

■ Relay 1: Control mode

1. Press the key  until R1-MO appears;
2. Press the key , and the cursor appears;
3. Press the key  to select RE or LOCAL;
4. Press the key  to confirm the selection, and the cursor disappears.







■ Relay 1: Return time

1. Press the key  until R1-RE appears;
2. Press the key , and the cursor appears;
3. Press the key  to modify the value;
4. Press the key  to confirm the new value, and the cursor disappears.





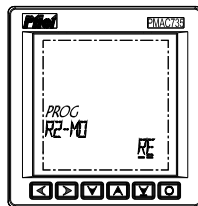

■ Relay 2: Control mode

1. Press the key  until R2-MO appears;
2. Press the key , and the cursor appears;
3. Press the key  to select RE or LOCAL;
4. Press the key  to confirm the selection, and the cursor disappears.





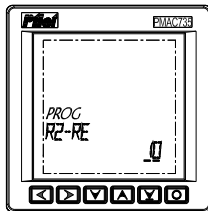

■ Relay 2: Return time

1. Press the key  until R2-RE appears;
2. Press the key , and the cursor appears;
3. Press the key  to modify the value;
4. Press the key  to confirm the new value, and the cursor disappears.





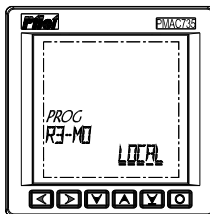

■ Relay 3: Control mode

1. Press the key  until R3-MO appears;
2. Press the key , and the cursor appears;
3. Press the key  to select RE or LOCAL;
4. Press the key  to confirm the selection, and the cursor disappears.





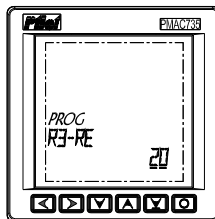

■ Relay 3: Return time

1. Press the key  until R3-RE appears;
2. Press the key , and the cursor appears;
3. Press the key  to modify the value;
4. Press the key  to confirm the new value, and the cursor disappears.





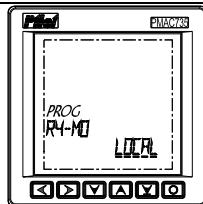

■ Relay 4: Control mode

1. Press the key  until R4-MO appears;
2. Press the key , and the cursor appears;
3. Press the key  to select RE or LOCAL;
4. Press the key  to confirm the selection, and the cursor disappears.





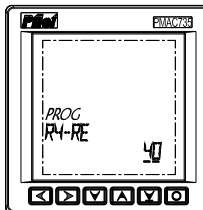

■ Relay 4: Return time

1. Press the key  until R4-RE appears;
2. Press the key , and the cursor appears;
3. Press the key  to modify the value;
4. Press the key  to confirm the new value, and the cursor disappears.



■ Recover system default parameters

1. Press the key  until RESET appears;
2. Press the key , and the cursor appears;
3. Press the key  to select YES or NO;
4. Press the key  to confirm the selection, and the cursor disappears (YES means executing clearance).

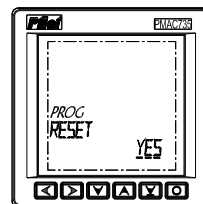



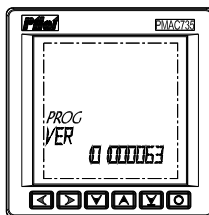

■ Version

1. Press the key  until VER appears.

(This item cannot be modified)



■ Password modification

1. Press the key  until CODE appears;
2. Press the key , and the cursor appears;
3. Press the key  to modify the value;
4. Press the key  to confirm the new value, and the cursor disappears. (Only the correct password be entered can this item be modified)

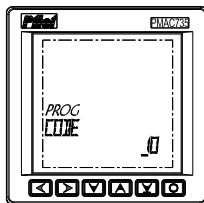

5. Input/output Characteristics (optional)

5.1 Status input

PMAC735A-/B-/E- provides 4 or 8 status input channels, which are used to detect state information such as breaker position signals and isolator position signals.

The DC voltage which product provides is not below 30V. On the site, dry nodes or passive auxiliary nodes can be connected directly. When external nodes are closed, the corresponding status input channels will be closed.

4 status input signals

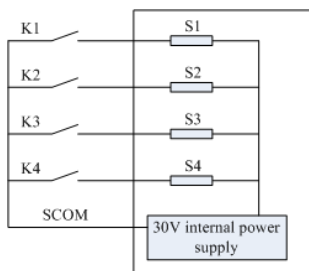

8 status input signals

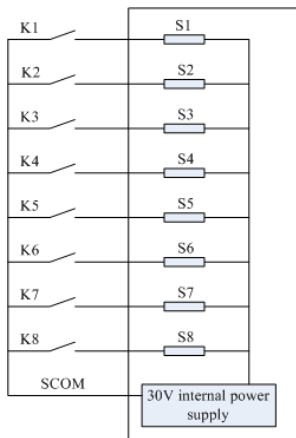

【Attention】

Since there is a power supply available for detection inside the meter, the external nodes cannot be further connected to any another voltage system. Otherwise, the status input channels will be burnt down.

5.2 Relay output

PMAC735A-/B- provides two relay operation modes. They are remote control and local control.

The action of relay is different in these two modes. So, users should distinguish the relay is in remote control mode or in local control mode at first.

The default control mode of this product is remote control. Users can change the mode through communication.

- ◆ Remote control (external) - The relay is controlled by a PC or PLC by using commands through communication.
- ◆ Local control (internal) - The relay is controlled by one of the electrical parameters inside the meter, which serves as the response to the control alarm conditions of a set point.

Once the relay has been in the remote control mode, even though the local control conditions have been set, the relay will not operate. The relay mode must be set at local control mode.

The two relay operation modes are as follows:

- ◆ Normal:
 - Remote control: By receiving a command from a PC or PLC, the relay closes. The relay's status will be kept until the PC or PLC gives a release command or the meter is de-energized.
 - Local control: When an alarm signal activating the relay is generated, the relay operates. The relay will not be released until all the alarm conditions activating the relay disappear or the meter is de-energized. If the power supply for the meter is resumed and the alarm conditions still exist, the relay will operate again.

- ◆ Time delay reset
 - Remote control: By receiving a command from a PC or PLC, the relay operates. The relay's operating status will be kept until a special timer overflows or the meter is de-energized. If, before the timer overflows, there is a new command that makes the relay operate, the timer will restart.
 - Local control: When an alarm signal activating the relay is generated, the relay operates. The relay's operating status will be kept within the period of time for timing. When the timer overflows, the relay will be released and kept released.

5.3 Pulse outputs

PMAC735E provides two pulse output outlets, one for active energy pulse output and the other for reactive energy pulse output. The user can self-define the type of energy, and the default types are active energy input and reactive energy input. The user can also forbid pulse outputs.

A typical wiring mode of external acquisition equipment is shown as follows:

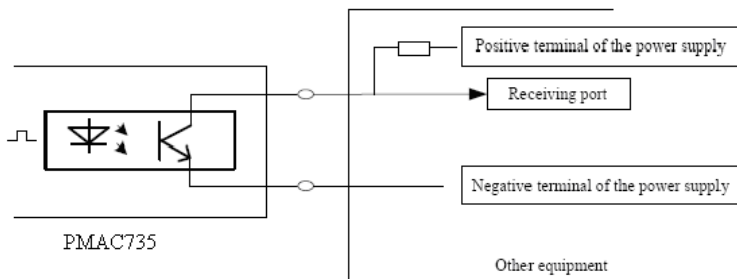

【Attention】

a. Different pulse acquisition devices have different operating modes. The pulse output port circuit provided by PMAC735E is adopting the collecting electrode open-circuit mode, isolated by optically coupled.

b. Electrical characteristics: For the collecting electrodes, open-circuit voltage: $48V \leq V_{cc} \leq 50V$; Current: $I_z \leq 50mA$.

The pulse outputs of PMAC735E correspond to the signal energy values inputted into the meter, and they can also be called secondary side energy values. When the user calculates the actual energy, the pulse outputs should be multiplied by the CT and PT factors. Each pulse does not represent one kilowatt-hour or kilovar-hour, so the user needs to set a reasonable pulse constant. The maximum setting range is between 1000 and 40000. The maximum pulse speed does not exceed 200 ms, which means that, when the accumulated energy of the meter is 1 kwh, the number of pulse outputs is N. Please note that the energy values here are all secondary side data. Therefore, when there are PTs and CTs, the primary side energy corresponding to N pulses should be $1 \text{ kwh} \times \text{PT} \times \text{CT}$.

The maximum settable scope of 220V/5A range is 1000 to 5000, those of 220V/1A and 100V/5A ranges are both 1000 to 20000, and that of 100V/1A range is 1000 to 40000.

The step lengths are all 100.

5.4 Analog output

PMAC735 can provide one optional 4-20 mA analog output, supporting the access of the DCS system. The user can, through the communication interface, set the parameter value corresponding to the analog output. The maximum load resistance of the interface should not exceed 500 Ohms.

On some sites, due to different transmission cables or loading conditions, the analog output at the high end appears to be non-linear. PMAC735 provides a settable magnification factor. By modifying the magnification factor, the user can adjust the proportion factor of the output curve.

The figure below shows the analog output characteristic curve, and the magnification factor is λ :

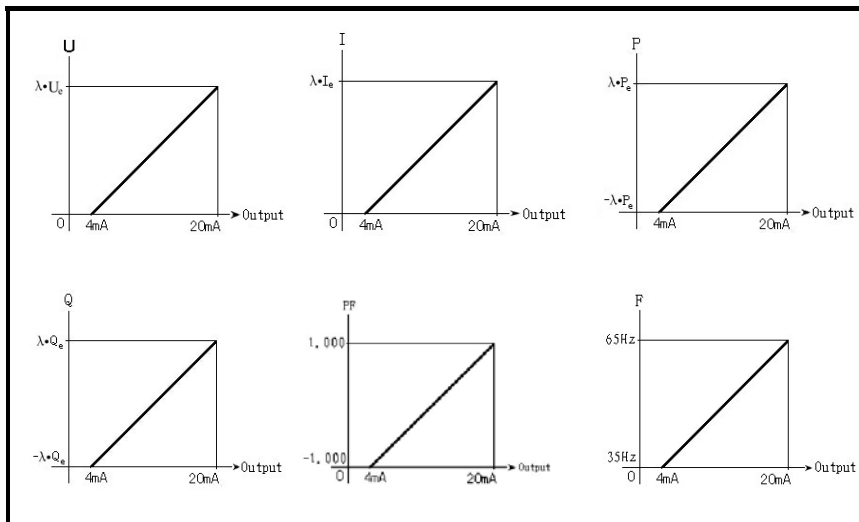

Notes:

$$P = \frac{(P_\lambda - 12)}{8} \times P_e \times \lambda \times CT \times PT$$

Where:

P_λ : Measured value of the analog quantity,

unit: mA;

P_e : Corresponding rated power value, unit:

W/Var;

λ : Magnification factor of the corresponding channel. Its range is between 1 and 10.

$$P_e = \sqrt{3} \times U_e \times I_e$$

Where:

U_e : Rated line voltage of the meter

I_e : Rated current of the meter

The analog output can be set as any of the items in the table below:

Voltage	Phase-A voltage	Phase-B voltage	Phase-C voltage
	Line AB voltage		
	Line BC voltage		
	Line CA voltage		
Current	Phase-A current	Phase-B current	Phase-C current
Active power	Total active power		
Reactive power	Total reactive power		
Power factor	Total power factor		
Frequency	System frequency		

Magnification factor: The minimum magnification factor is 1, and the maximum is 10. Default factor is 1.

6. Alarm System (optional)

PMAC735A-/B- provides multiple relay alarm outputs, any of which can work independently and support the user's programming.

Any of the relay output that has been set at local control mode corresponds to alarm about voltage or current. Each alarm needs 5 parameters programmed, as shown in the table below:

Operation-object	0 – Prohibit 1 - Maximum value of three-phase voltage 2 - Minimum value of three-phase voltage 3 - Maximum value of three-phase line voltage 4 - Minimum value of three-phase line voltage 5 - Maximum value of three-phase current 6 - Minimum value of three-phase current
Operation upper limit value	0% - 120% of rated value
Operation lower limit value	0% - 120% of rated value
Operation time delay	0 – 1200s; 0 means that the relay operates immediately.
Return time	0 – 1200s; 0 means no return.

For example, the user needs to monitor whether there is under-voltage in three phases. If there is under-voltage in any phase, alarm will be given immediately until normal voltage is resumed. Then, programming can be carried out according to the following settings:

Operation-object: Minimum value of three-phase voltage

Operation upper limit value: 120

Operation lower limit value: 80 (it is assumed here that under-voltage refers to a voltage lower than 80% of the rated voltage)

Operation time: 0 s

Return time: 0 s

Other values can be set according to the above procedure, and descriptions will not be given one by one.

7. SOE /Event Log (optional)

PMAC735 provides optional function of recording up to 50 SOE events, and the records can be kept for more than 10 years.

The SOE recording function can record the displacements of switch contacts. When an event occurs, the meter will automatically record the type of the event such as closing of status 1. At the same time, the year, month, day, hour, minute, second, millisecond when the event occurs will be recorded precisely, and the resolution is 2 ms.

Users can read all the SOE records through communication. For details, refer to “SOE” (event log).

A standard structure of SOE event data is as follows:

No. of the relative byte	Definition	Description
0	Type of event	1 – S1 channel 2 – S2 channel 8 – S8 channel
1	Status of operation	0 – Off 1 – On
2 – 3	Millisecond	
4 – 5	UNIX clock low word	
6 – 7	UNIX clock high word	

The basis reference of the UNIX clock is 00:00:00 January 1, 1970 (Greenwich Mean Time). For time conversion, please pay attention to the time difference of your time zone. For example, there is an 8-hour time difference between the time of Beijing time zone and the standard UNIX.

8. Communication Protocol

8.1 Overview

PMAC735 main unit provides the MODBUS-RTU communication protocol, 8 data bits, 1 stop bit, without check bit. Each frame data package contains the address field, functional code field, data field, and check field. The maximum length of each data package is 95 bytes.

The length of the address field is 1 byte, and the content is slave station address. The range of an effective slave station address is 1 to 247. If the slave station receives a package in which the address field information conforms to its own address, it should execute the commands contained in the package. In the package to which the slave station responds, the field is its own address.

The length of the functional code field is 1 byte, used to tell the slave station to execute what operations. The functional codes supported by PMAC735 are listed in the table below:

Functional code	Meaning	Function
0x03	Read register	Obtaining one or more than one current register values inside the current PMAC735.
0x10	Setting register	Writing the designated values into one or more than one registers inside PMAC735.
0x05	Relay control	Controlling a relay inside the current PMAC735.

The length of the data field is not fixed, and it will be defined according to the specific function.

The data in the data field adopts the BIG INDIAN mode, with the high bytes in front and the low bytes at the back.

The check field adopts 16-bit CRC check codes. The transmitting device should make CRC calculation for each of the data inside the package, and the final results will be stored in the check

field. The receiving device should also make CRC calculation for each of the data (except the check field) inside the package and compare the results with the check field. Only the same package will be accepted.

8.2 Abnormal response

If the main station sends an illegal package or asks for an invalid data register, an abnormal data response will be generated. This abnormal data response is composed of the slave station address, functional code, trouble code, and check field. When the highest bit of the functional code field is 1, it means that the data frame is an abnormal response at this time. The table below describes the meanings of abnormal functional codes:

Trouble code	Description
01H	Illegal operation functional code received.
02H	Illegal register operation or over-long data received.

8.3 Relay control

The functional code is 05H.

In this mode, only individual relay can be controlled. The status of a relay can be obtained by reading the relay status register. The relay address starts from 0 in the register. The address of relay 1 is 0, and the rest may be deduced by analogy. Sending hexadecimal FF 00 closes a relay and sending hexadecimal 00 00 releases a relay. All the other values will be invalid.

Control relay format (Main station→PMA735)		Response format (PMA735→main station)	
Slave station address	1 byte	Slave station address	1 byte
Functional code 05H	1 byte	Functional code 05H	1 byte
Channel address	2 bytes	Channel address	2 bytes
Control command	2 bytes	Control command	2 bytes
CRC check code	2 bytes	CRC check code	2 bytes

8.4 Register reading

The functional code is 03H.

The main station can read one or more than one register values, and the register return values not defined are 0.

Read register format (Main station→PMAC735)		Response format (PMAC735→main station)	
Slave station address	1 byte	Slave station address	1 byte
Functional code 03H	1 byte	Functional code 03H	1 byte
Start address	2 bytes	Byte number (2×number of registers)	1 byte
Number of registers	2 bytes	Data of the first register	2 bytes
CRC check code	2 bytes	Data of the second register	2 bytes
		
		CRC check code	2 bytes

Note: The values of up to 45 registers can be read at one time.

8.5 Register setting

The functional code is 10H.

The main station can set one or more than one register values, and the register operations not defined are invalid.

Write register format (Main station→PMAC735)		Response format (PMAC735→main station)	
Slave station address	1 byte	Slave station address	1 byte
Functional code 10H	1 byte	Functional code 10H	1 byte
Start address	2 bytes	Start address	2 bytes
Number of registers	2 bytes	Number of registers	2 bytes
Byte number (2× number of registers)	1 byte	CRC check code	2 bytes
Data of the first register			
Data of the second register			
.....			
CRC check code	2 bytes		

8.6 Description of data types

UINT16	Unsigned 16-digit integer
INT16	Signed 16-digit integer
LUINT32	Unsigned 32-digit integer
LINT32	Signed 32-digit integer
WORD16	Bit denotation word, applicable to on-off and relay status. D0 refers to the first on-off or relay channel. D1 refers to the second on-off or relay channel. The rest bits may be deduced by analogy. Bit 0 refers to “off”, and bit 1 refers to “on”.

8.7 Calculation factors

Due to the restriction of the value ranges, many of the data registers of PMAC735 use calculation factors. This means that, if the user wants to obtain the actual values, the corresponding calculation factors must be multiplied.

For example, the calculation factor of the power factor register is 0.001. When the value read by the user at this time is 892, the current power factor will be: $892 \times 0.001 = 0.892$.

8.8 Communication values and actual values

To ensure that the meter keeps adequate accuracy bits when transmitting data, some of the real-time data registers of PMAC735 adopt some special processing methods, as shown in the table below:

No.	Content	Communication value	Actual value
1	Per phase/line voltage Average phase/line voltage Neutral voltage	Secondary side	Communication value * calculation factor * PT
2	Per phase current Average phase current Neutral current Current demand / minimum/maximum value	Secondary side	Communication value * calculation factor * CT
3	Per phase power Total power Power demand	Secondary side	Communication value * calculation factor * PT * CT

Using secondary side data to transmit numeric values can maintain the calculation accuracy to the utmost extent. The user must, during processing, pay attention to the transformation ratios of the corresponding PT and CT.

8.9 List of universal data registers

Register address	Definition	Data type	Description
40001	Phase A voltage	UNIT16	Calculation factor: 0.01, unit: V
40002	Phase B voltage		
40003	Phase C voltage		
40004	Line AB voltage		
40005	Line BC voltage		
40006	Line CA voltage		
40007	Phase A current		Calculation factor: 0.001, unit: A
40008	Phase B current		
40009	Phase C current		
40010	Neutral current		
40011	Three-phase active power low word	LINT32	Calculation factor: 0.1, unit: W
40012	Three-phase active power high word		
40013	Three-phase reactive power low word		Calculation factor: 0.1, unit: Var
40014	Three-phase reactive power high word		
40015	Three-phase apparent power low word	LUINT32	Calculation factor: 0.1, unit: VA

40016	Three-phase apparent power high word			
40017	Total power factor	INT16	Calculation factor: 0.001.	
40018	Frequency	UINT16	Calculation factor: 0.01, unit: Hz	
40019	Input active energy low word	LUINT32	Calculation factor: 0.1, unit: kwh	
40020	Input active energy high word			
40021	Input reactive energy low word		Calculation factor: 0.1, unit: kvarh	
40022	Input reactive energy high word			
40023	Output active energy low word		Calculation factor: 0.1, unit: kwh	
40024	Output active energy high word			
40025	Output reactive energy low word		Calculation factor: 0.1, unit: kvarh	
40026	Output reactive energy high word			
40027	On-off status		WORD16	When any bit is 0, that means

40028	Relay status		the corresponding contact is cut, otherwise is closed.
40029	Va/Vab - THD	UINT16	Calculation factor: 0.001
40030	Vb/Vbc - THD		
40031	Vc/Vca - THD		
40032	Ia - THD		
40033	Ib - THD		
40034	Ic - THD		
40035	Ia – K factor		
40036	Ib – K factor		
40037	Ic – K factor		
40038	Average phase current demand		UNIT16
40039	Three-phase active power demand	LINT32	Calculation factor: 0.1, unit: W
40040			
40041	Three-phase reactive power demand		Calculation factor: 0.1, unit: Var
40042			
40043	Three-phase apparent power demand	LUINT32	Calculation factor: 0.1, unit: VA
40044			
40045	SOE event counter	UINT16	0 – 59, 999

8.10 List of real-time measured data registers

Register address	Definition	Data type	Description
40101	Phase A voltage	UINT16	Calculation factor: 0.01, unit: V
40102	Phase B voltage		
40103	Phase C voltage		
40104	Phase voltage unbalance rate		Calculation factor: 0.001
40105	Average phase voltage		Calculation factor: 0.01, unit: V
40106	Line AB voltage		
40107	Line BC voltage		
40108	Line CA voltage		
40109	Line voltage unbalance rate		Calculation factor: 0.001
40110	Average line voltage		Calculation factor: 0.01, unit: V
40111	Neutral voltage		
40112	Phase A current	UINT16	Calculation factor: 0.001, unit: A
40113	Phase B current		
40114	Phase C current		
40115	Current unbalance rate		Calculation factor: 0.001
40116	Average phase current		Calculation factor: 0.001, unit: A
40117	Neutral current		
40118	Phase A active power		INT16

40119	Phase B active power		
40120	Phase C active power		
40121	Total active power low word	LINT32	
40122	Total active power high word		
40123	Phase A reactive power	INT16	Calculation factor: 0. 1, unit: Var
40124	Phase B reactive power		
40125	Phase C reactive power		
40126	Total reactive power low word	LINT32	
40127	Total reactive power high word		
40128	Phase A apparent power	UINT16	Calculation factor: 0.1, unit: VA
40129	Phase B apparent power		
40130	Phase C apparent power		
40131	Total apparent power low word	LUINT32	
40132	Total apparent power high word		
40133	Phase A power factor	INT16	Calculation factor: 0.001
40134	Phase B power factor		
40135	Phase C power factor		

40136	Total power factor		
40137	Frequency	UINT16	Calculation factor: 0.01, unit: Hz
40138	On-off status	WORD16	When any bit is 0, that means the corresponding contact is cut, otherwise is closed.
40139	Relay status		

8.11 List of energy data registers

Register address	Definition	Data type	Description
40201	Input active energy low word	LUINT32	Calculation factor: 0.1, unit: kwh
40202	Input active energy high word		
40203	Input reactive energy low word		Calculation factor: 0.1, unit: kvarh
40204	Input reactive energy high word		
40205	Output active energy low word		Calculation factor: 0.1, unit: kwh
40206	Output active energy high word		
40207	Output reactive energy low word		Calculation factor: 0.1, unit: kvarh
40208	Output reactive energy high word		
40209	First-quadrant active energy low word		Calculation factor: 0.1, unit: kwh
40210	First-quadrant active energy high word		
40211	Second-quadrant active energy low word		
40212	Second-quadrant active energy high word		
40213	Third-quadrant active energy low word		
40214	Third-quadrant active energy high word		

40215	Fourth-quadrant active energy low word		Calculation factor: 0.1, unit: kvarh
40216	Fourth-quadrant active energy high word		
40217	First-quadrant reactive energy low word		
40218	First-quadrant reactive energy high word		
40219	Second-quadrant reactive energy low word		
40220	Second-quadrant reactive energy high word		
40221	Third-quadrant reactive energy low word		
40222	Third-quadrant reactive energy high word		
40223	Fourth-quadrant reactive energy low word		
40224	Fourth-quadrant reactive energy high word		

8.12 List of demand data registers

Register address	Definition	Data type	Description
40301	Average current demand	UNIT16	Calculation factor: 0.001, unit: A
40302	Total active power demand low word	LINT32	Calculation factor: 0.1, unit: W
40303	Total active power demand high word		
40304	Total reactive power demand low word		
40305	Total reactive power demand high word		
40306	Total apparent power demand low word	LUINT32	Calculation factor: 0.1, unit: VA
40307	Total apparent power demand high word		
40308	Maximum average current demand	UNIT16	Calculation factor: 0.001, unit: A
40309	Date of max. current demand: year, month	UNIT16	High byte: year, low byte: month
40310	Time of max. current demand: day, hour	UNIT16	High byte: day, low byte: hour
40311	Time of max. current demand:	UNIT16	High byte: minute,

	minute, second		low byte: second
40312	Maximum total active power demand low word	LINT32	Calculation factor: 0.1, unit: W
40313	Maximum total active power demand high word		
40314	Date of max. total active power demand: year, month	UNIT16	High byte: year, low byte: month
40315	Time of max. total active power demand: day, hour	UNIT16	High byte: day, low byte: hour
40316	Time of max. total active power demand: minute, second	UNIT16	High byte: minute, low byte: second
40317	Maximum total reactive power demand low word	LINT32	Calculation factor: 0. 1, unit: Var
40318	Maximum total reactive power demand high word		
40319	Date of max. total reactive power demand: year, month	UNIT16	High byte: year, low byte: month
40320	Time of max. total reactive power demand: day, hour	UNIT16	High byte: day, low byte: hour
40321	Time of max. total reactive power demand: minute, second.	UNIT16	High byte: minute, low byte: second

40322	Maximum total apparent power demand low word	LUINT32	Calculation factor: 0.1, unit: VA
40323	Maximum total apparent power demand high word		
40324	Date of max. total apparent power demand: year, month	UNIT16	High byte: year, low byte: month
40325	Time of max. total apparent power demand: day, hour	UNIT16	High byte: day, low byte: hour
40326	Time of max. total apparent power demand: minute, second	UNIT16	High byte: minute, low byte: second

8.13 List of harmonic data registers

Register address	Definition	Data type	Description
40401	Va/Vab – THD	UNIT16	Calculation factor: 0.001
40402	Vb/Vbc – THD		
40403	Vc/Vca – THD		
40404	Ia – THD		
40405	Ib – THD		
40406	Ic – THD		
40407	Ia – K factor		
40408	Ib – K factor		
40409	Ic – K factor		
40410	2 nd harmonic component of Va/Vab	UINT16	Calculation factor: 0.001
40411	2 nd harmonic component of Vb/Vbc		
40412	2 nd harmonic component of Vc/Vca		
40413	2 nd harmonic component of Ia		
40414	2 nd harmonic component of Ib		
40415	2 nd harmonic component of Ic		
40416	3 rd harmonic component of Va/Vab		
40417	3 rd harmonic component of Vb/Vbc		
40418	3 rd harmonic component of Vc/Vca		
40419	3 rd harmonic component of Ia		
40420	3 rd harmonic component of Ib		

40421	3 rd harmonic component of Ic		
40422	4 th harmonic component of Va/Vab		
40423	4 th harmonic component of Vb/Vbc		
40424	4 th harmonic component of Vc/Vca		
40425	4 th harmonic component of Ia		
40426	4 th of harmonic component Ib		
40427	4 th of harmonic component Ic		
...
40584	31 st harmonic component of Va/Vab	UINT16	Calculation factor: 0.001
40585	31 st harmonic component of Vb/Vbc		
40586	31 st harmonic component of Vc/Vca		
40587	31 st harmonic component of Ia		
40588	31 st harmonic component of Ib		
40589	31 st harmonic component of Ic		

8.14 List of max./min. real time data register

Register address	Definition	Read/write attribute	Description
40601	Maximum phase A current	RO	Calculation factor: 0.001, unit: A
40602	Maximum phase B current	RO	

40603	Maximum phase C current	RO	
40604	Maximum total active power low word	RO	Calculation factor: 0.1, unit: W
40605	Maximum total active power high word	RO	
40606	Maximum total reactive power low word	RO	Calculation factor: 0.1, unit: Var
40607	Maximum total reactive power high word	RO	
40608	Maximum total apparent power low word	RO	Calculation factor: 0.1, unit: VA
40609	Maximum total apparent power high word	RO	
40610	Maximum Ia-THD	RO	Calculation factor: 0.001
40611	Maximum Ib-THD	RO	
40612	Maximum Ic-THD	RO	
40613	Maximum Va-THD	RO	
40614	Maximum Vb-THD	RO	
40615	Maximum Vc-THD	RO	
Register address	Definition	Read/write attribute	Description
40616	Minimum phase A current	RO	Calculation factor: 0.001, unit: A
40617	Minimum phase B current	RO	

40618	Minimum phase C current	RO	
40619	Minimum total active power low word	RO	Calculation factor: 0.1, unit: W
40620	Minimum total active power high word	RO	
40621	Minimum total reactive power low word	RO	Calculation factor: 0.1, unit: Var
40622	Minimum total reactive power high word	RO	
40623	Minimum total apparent power low word	RO	Calculation factor: 0.1, unit: VA
40624	Minimum total apparent power high word	RO	
40625	Minimum Ia-THD	RO	Calculation factor: 0.001
40626	Minimum Ib-THD	RO	
40627	Minimum Ic-THD	RO	
40628	Minimum Va-THD	RO	
40629	Minimum Vb-THD	RO	
40630	Minimum Vc-THD	RO	

8.15 List of SOE and time registers

Register address	Definition	Read/write attribute	Description
40701	Year	R/W	0 – 99
40702	Month	R/W	1 – 12
40703	Day	R/W	1 – 31
40704	Hour	R/W	0 – 23
40705	Minute	R/W	0 – 59
40706	Second	R/W	0 – 59
40707	UNIX clock low word	R/W	
40708	UNIX clock high word	R/W	
40709	UNIX clock millisecond	R/W	0 – 999
40710	SOE event counter	RO	0 – 59, 999
40711 – 40714	1 st event log	RO	
40715 – 40718	2 nd event log	RO	
...
40907 – 40910	50th event log	RO	

Notes concerning writing/reading:

1. The 6 time registers starting from 40701 must be written and read simultaneously, and the writing/reading must begin with 40701, otherwise the writing/reading will be invalid.
2. The two Unix time registers starting from 40707 must be written/read simultaneously, and the writing/reading must begin with 40707, otherwise the writing/reading will be invalid.
3. The SOE event counter 40710 is only allowed to be read alone.
4. The event records must be read from the starting point of each event, and the number of register must be an integral multiple of 4, otherwise the reading will be invalid.

8.16 List of configuration registers

Register address	Definition	Read/write attribute	Description
41001	CT primary side setting	R/W	1 ~49,999
41002	CT secondary side setting	RO	5 or 1
41003	PT primary side setting low word	R/W	1 ~500,000
41004	PT primary side setting high word	R/W	
41005	PT secondary side setting	R/W	1 ~200
41006	Measuring mode	R/W	0 – 4-line star connection 1 – 3-phase delta connection
41007	Communication address	R/W	1 ~247
41008	Communication baud rate	R/W	0 – 4800 1 – 9600 2 – 19200 3 – 38400
41009	Reserved		
41010	Clear max. /min. real time data	WO	FF clearance
41011	Clear energy data	WO	FF clearance
41012	Clear demand data	WO	FF clearance
41013	Clear event logging	WO	FF clearance

41014 – 41015	Reserved		
41016	Return time of relay 1	R/W	0 – 1200s 0 means blocking.
41017	Return time of relay 2	R/W	0 – 1200s 0 means blocking.
41018	Return time of relay 3	R/W	0 – 1200s 0 means blocking.
41019	Return time of relay 4	R/W	0 – 1200s 0 means blocking.
41020 – 41021	Reserved		
41022	Active energy pulse output	R/W	0 – Off 1 – Active energy input 2 – Active energy output
41023	Reactive energy pulse output	R/W	0 – Off 1 – Reactive energy input 2 – Reactive energy output
41024	Pulse output constant	R/W	220 V/5 A, range: 1000 – 5000 100 V/5 A, 220 V/1 A, range: 1000 – 20000 100 V/1 A, range: 1000 – 40000 The step length is 100.

41025	Objects of analog output	R/W	0 – Off 1 – Phase A voltage 2 – Phase B voltage 3 – Phase C voltage 4 – Line AB voltage 5 – Line BC voltage 6 – Line CA voltage 7 – Phase A current 8 – Phase B current 9 – Phase C current 10 – Total active power 11 – Total reactive power 12 – Total power factor 13 – Frequency
41026	Analog output factor	R/W	10 – 100
41027 – 41030	Reserved		
41031	Control mode of relay 1	R/W	0 – Local control 1 – Remote control
41032	Operation-object of relay 1	R/W	0 – Disable 1 – Maximum value of three-phase phase voltage 2 – Minimum value of three-phase phase voltage 3 – Maximum value of three-phase line voltage

			<p>4 – Minimum value of three-phase line voltage</p> <p>5 – Maximum value of three-phase current</p> <p>6 –Minimum value of three-phase current</p>
41033	Operation upper limit value of relay 1	R/W	0 – 120%
41034	Operation lower limit value of relay 1	R/W	0 – 120%
41035	Action time delay of relay 1	R/W	0 – 1200s
41036	Control mode of relay 2	R/W	<p>0 –Local control</p> <p>1 –Remote control</p>
41037	Operation-object of relay 2	R/W	<p>0 – Disable</p> <p>1 – Maximum value of three-phase phase voltage</p> <p>2 – Minimum value of three-phase phase voltage</p> <p>3 – Maximum value of three-phase line voltage</p> <p>4 – Minimum value of three-phase line voltage</p> <p>5 – Maximum value of three-phase current</p>

			6 – Minimum value of three-phase current
41038	Operation upper limit value of relay 2	R/W	0 – 120%
41039	Operation lower limit value of relay 2	R/W	0 – 120%
41040	Action time delay of relay 2	R/W	0 – 1200s
41041	Control mode of relay 3	R/W	0 – Local control 1 – Remote control
41042	Operation-object of relay 3	R/W	0 – Disable 1 – Maximum value of three-phase phase voltage 2 – Minimum value of three-phase phase voltage 3 – Maximum value of three-phase line voltage 4 – Minimum value of three-phase line voltage 5 – Maximum value of three-phase current 6 – Minimum value of three-phase current
41043	Operation upper limit value of relay 3	R/W	0 – 120%

41044	Operation lower limit value of relay 3	R/W	0 – 120%
41045	Action time delay of relay 3	R/W	0 – 1200s
41046	Control mode of relay 4	R/W	0 – Local control 1 – Remote control
41047	Operation-object of relay 4	R/W	0 – Disable 1 – Maximum value of three-phase phase voltage 2 – Minimum value of three-phase phase voltage 3 – Maximum value of three-phase line voltage 4 – Minimum value of three-phase line voltage 5 – Maximum value of three-phase current 6 – Minimum value of three-phase current
41048	Operation upper limit value of relay 4	R/W	0 – 120%
41049	Operation lower limit value of relay 4	R/W	0 – 120%
41050	Action time delay of relay 4	R/W	0 – 1200s

8.17 List of energy setting registers

Register address	Definition	Read/write attribute	Description
41101	First-quadrant active energy low word	WO	0 – 999, 999, 999 Calculation factor: 0. 1
41102	First-quadrant active energy high word		
41103	Second-quadrant active energy low word		
41104	Second-quadrant active energy high word		
41105	Third-quadrant active energy low word		
41106	Third-quadrant active energy high word		
41107	Fourth-quadrant active energy low word		
41108	Fourth-quadrant active energy high word		
41109	First-quadrant reactive energy low word		
41110	First-quadrant reactive energy high word		

41111	Second-quadrant reactive energy low word		
41112	Second-quadrant reactive energy high word		
41113	Third-quadrant reactive energy low word		
41114	Third-quadrant reactive energy high word		
41115	Fourth-quadrant reactive energy low word		
41116	Fourth-quadrant reactive energy high word		

8.18 05H command control relays

Register address	Definition	Read/write attribute	Description
00	Channel of relay 1	WO	FF00 – Close 0000 – Release
01	Channel of relay 2		
02	Channel of relay 3		
03	Channel of relay 4		

9. Maintenance and Trouble Shooting

Possible problem	Possible cause	Possible solution
The meter has no indication after the control power supply is imposed.	The power supply fails to be imposed on the meter.	Check if the correct working voltage has been imposed on the L/+ and N/- terminals of the meter. Check if the fuse for the control power supply has been burnt down.
The measured value is not correct or does not conform to the expectation.	The voltage measurement is not correct.	Check if the neutral point has been connected reliably. Check if the measured voltage matches the rated parameter of the meter. Check if the transformation ratio of the PT has been set correctly.
	The current measurement is not correct.	Check if the measured current matches the rated parameter of the meter. Check if the transformation ratio of the CT has been set correctly.

	<p>The power measurement is not correct.</p>	<p>Check if the measurement mode has been set correctly.</p> <p>Check if the phase sequence corresponding to the voltage and the current is correct.</p> <p>Check if the current terminals of the same name are wrong.</p>
<p>There is no change in the on-off status.</p>	<p>The on-off operating voltage is not correct.</p>	<p>Check if the types of external nodes match the rated parameters of the meter.</p> <p>Check if the external connection is correct.</p>
<p>The relay does not operate.</p>	<p>The relay does not receive the control command.</p>	<p>Check if the communication link is correct.</p>
	<p>The working mode of the relay is not correct.</p>	<p>Check if the current relay is under the correct mode.</p>
	<p>The operating time has not been set correctly.</p>	<p>Check the setting of the operating time of the relay. For the specific information, refer to the content regarding relays of the operation manual.</p>

No analog output.	The analog is set as “disable” or wrong object.	Check through communication the setting of analog.
No pulse output or incorrect pulse output	The setting of the pulse object or constant is wrong.	Check through communication the setting of pulse.
There is no communication between the upper end device and the meter.	The communication address of the meter is not correct.	Check if the address of the meter is consistent with its definition or if there are more than two identical addresses in the same network.
	The communication speed of the meter is not correct.	Check if the communication speed of the meter is consistent with its definition.
	The communication link has not been connected to the terminal resistor.	Check if the 120-Ohm resistor has been connected.
	The communication link suffers interference.	Check if the communication-shielding layer has been earthed effectively.
	The communication line is interrupted.	Check if the communication cable has been disconnected.

10. Technical Datasheet

Structural dimensions	Panel: 96.00×96.00mm Installation: 89.50×89.50mm Depth of main body: 65.00mm Depth of extension module: 25.00mm
Type of display	LCD
Connection of terminals	Standard 5.08-mm pluggable terminals. The current terminals are equipped with fasteners to prevent accidental coming off.
Working power supply	85-265 VAC/45-65 Hz, 100-300 VDC
Weight	0.5Kg

Measuring accuracy	
Voltage	0.2%, typical measure 0.1%
Current	0.2%, typical measure 0.1%
Active Power	0.5%
Power factor	0.5%
Frequency	0.01Hz
Active Energy	1%

Environment	
Operating temperature	-20°C ~ +60°C
Storage temperature	-30°C ~ +70°C
Relative humidity	5% ~ 90% RH, non-condensing

EMC	
Electrostatic Discharge Immunity Test	IEC 61000-4-2,Level 4
Radiated immunity test	IEC 61000-4-3,Level 3
Electrical fast transient/burst immunity test	IEC 61000-4-4,Level 4
Surge immunity test (1, 2/50µs~8/20µs)	IEC 61000-4-5,Level 3
Conducted emissions	EN 55022,Class B
Radiated emissions	EN 55022,Class B

Notice:

- PILOT reserves the right to modify this manual without prior notice in view of continued improvement.
- Technical Consulting: +86 15916202620
- After-sale Services: +86 15916202800
- Email: pilot166@pmac.com.cn

***Pilot* Zhuhai Pilot Technology Co., Ltd.**

Add: No. 15, Keji 6 Road, Chuangxin Haian, Tangjia High-tech Zone, Zhuhai, Guangdong, 519085 China

Tel: +86 -756-3629687/ 3629688

Fax: +86-756-3629600/ 3629670

<http://www.pmac.com.cn>