

# Energom-3M1C

## Single Phase Energy Meter(CTs)



Version: 1.10

Revision: 2024.9



# Read me

**When you use EnergoM-3M1C single phase energy meter, be sure to read this user manual carefully, and be able to fully understand the implications, the correct guidance of operations in accordance with user manual, which will help you make better use of EnergoM-3M1C single phase energy meter, and help to solve the various problems at the scene.**

1. Before the meter turning on the power supply, be sure that the power supply within the provisions of the instrument;
2. When installation, the current input terminal must non-open, voltage input terminals must Non-short circuit;
3. Communication terminal (RS232/RS485) is strictly prohibited to impose on high pressure;
4. Be sure the instrument wiring consistent with the internal system settings;
5. When communicating with the PC, instrument communication parameters must be consistent with the PC.



- **Please read this user manual carefully**
- **Please save this document**

# Directory

<b>1. - SUMMARIZE.....</b>	<b>3</b>
<b>2. - TECHNICAL PARAMETERS .....</b>	<b>4</b>
<b>3. - INSTALLATION AND START-UP.....</b>	<b>5</b>
3.1. - INSTALLATION .....	5
3.2. - CONNECTION TERMINAL.....	9
3.3. – TYPICAL WIRING.....	10
<b>4. - SCREEN DISPLAY .....</b>	<b>11</b>
4.1. - SCREEN DESCRIPTION: .....	11
4.2. - INDICATOR LIGHT DESCRIPTION: .....	11
4.3. - SCREEN PAGES’ DESCRIPTION: .....	12
<b>5. OPERATION MENU DESCRIPTION .....</b>	<b>15</b>
5.1 BUTON DESCRIPTION .....	15
5.2 MAIN MENU.....	16
<b>6.- PULSE OUTPUT (OPTIONAL).....</b>	<b>18</b>
<b>7 - COMMUNICATION INTERFACE .....</b>	<b>19</b>
7.1. - CONNECTION FOR RS485 BUS.....	19
7.2. - MODBUS © PROTOCOL .....	20
7.3. - REGISTER MAP .....	21
7.3.1.- <i>Basic power data—Primary Side</i> .....	21
7.3.2.- <i>Basic power data—Secondary Side</i> .....	22
7.4. - EXAMPLE .....	23
<b>8. - SAFETY CONSIDERATIONS .....</b>	<b>24</b>
<b>9. - MAINTENANCE .....</b>	<b>24</b>
<b>10. - TECHNICAL SERVICE .....</b>	<b>25</b>

## **1. - SUMMARIZE**

Single-phase rail-type electric energy meter is an intelligent device used in medium and low voltage systems (6-35KV and 0.4KV). It integrates data acquisition and control functions, adopts segment code LCD screen, and has single-phase AC power measurement and calculation. Energy accumulation, RS485 communication and other functions.

Energom-3M1C single phase energy meter is a 3M width DIN rail energy meter, and use external CT to expand the current range max to 999A. With RS485-RTU and pulse output port, the LCD screen provides measurement circuit current and voltage reading. This Energom-3M1C single phase energy meter suits scenarios such as residential, public facilities, and industrial use.

### **FEATURES**

- Maximum 999A, 1A/5A CT connection;
- Provide energy import and export measurement (IMP & EXP);
- With one port energy pulse output;
- RS485 Modbus communication (optional);
- Standard 35mm din rail mounting, width 3M size;
- Detect voltage, current, active/reactive energy, power, frequency, Max demand, etc.

### **APPLICATIONS**

- All power parameter measurement;
- Energy measurement and electrical fire monitor and control;
- Transformers, generators, capacitors and electric motors distributed detection;
- Medium and low pressure systems;
- SCADA, EMS, DCS integrators.

## 2. - TECHNICAL PARAMETERS

### Measurement & Display

Voltage	Rated 230V RMS value, Accuracy 0.2%,
Current	Rated 5A, Optional 1A, CT Connection, RMS value. Accuracy 0.2%;
Overload	1.2 times rated continuous; 1 seconds for 10 times the rated
Frequency	50/60Hz, Accuracy $\pm 0.01$ Hz
Display	LCD with white backlit
Maximum display value	9999999MkWh
AUX Power	90-240V AC, <2W/10VA

### Output

Digital port	RS-485 MODBUS-RTU
Pulse port	1600imp/kWh

### Other parameters

Working environment	-25~55°C Altitude $\leq 2500$ m, 0~95%RH, non-condensing, non-corrosive gas
Storage environment	-40~70°C
Voltage tolerance	2KV 1min
Shock voltage	6KV-1.2uS waveform
Insulation	Input, output, power supply to Shell $>5M\Omega$

### 3. - INSTALLATION AND START-UP



The manual you hold in your hand contains information and warnings that the user should respect in order to guarantee a proper operation of all the instrument functions and keep it in safety conditions. The instrument must not be powered on and used until its definitive assembly is on the cabinet's door.

**If the instrument is not used as manufacturer's specifications, the protection of the instrument will be damaged.**

When any protection failure is suspected to exist (for example, it presents external visible damages), the instrument must be immediately powered off. In this case contact a qualified service representative.

#### 3.1.- Installation

##### Mounting

Instrument is to be mounted on 35mm Din-rail. Keep all connections into the cabinet. Please note that with the instrument powered on, the terminals could be dangerous to touch and cover opening actions or elements removal may allow accessing dangerous parts. Therefore, the instrument must not be used until this is completely installed.

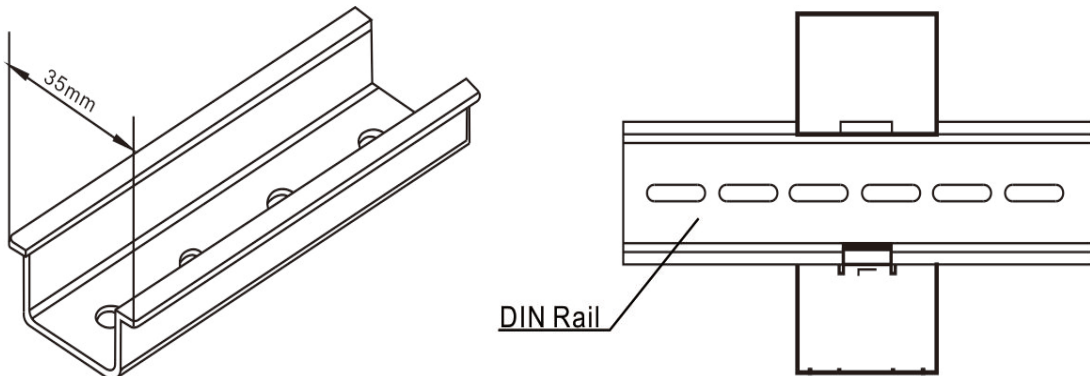

Dimension:

Unit: mm

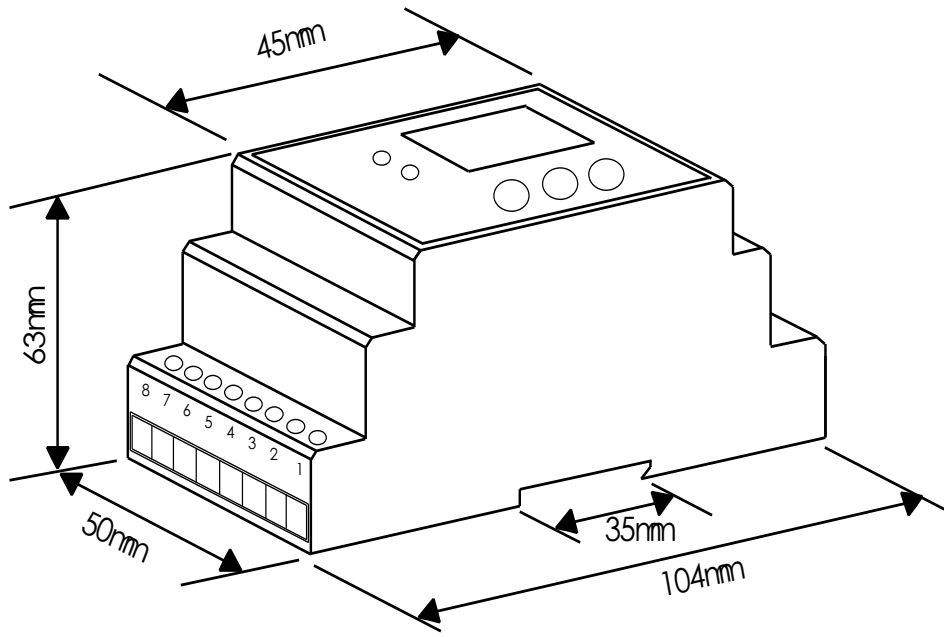

Side view



## Notes:

Input signal: EnergoM-3M1C using a separate acquisition calculate for each measurement channel, to ensure consistent in use, for different load forms, it's a variety of connection mode. Access wire shall be met 3 square mm.

### A. Voltage input

Input voltage should not exceed the rated input voltage products 450V. Otherwise, you should use external VT. Suggest 1A fuse be installed in the voltage input side.

### B. Current Input

Standard input current is 5A or 1A, if greater than 5A/1A should use external CT. When the CT is connected with other meters, make sure wiring methods be used in series.

**Warning: Forbid to install a CT on the live feeder wire with open secondary leads. This can be extremely dangerous!**

Before remove the current input connection, must be sure to disconnect the primary circuit or shorted secondary circuit of CT.

### C. Sequence of wire

**Warning: Please make sure that the input voltage and current corresponding to the same phase, sequence, and the same direction; Otherwise, the Values and symbols will be wrong! (Power and Energy)**

Always observe the physical orientation of CT (P1 - P2) when installing on the feeder wire. Always pay attention to wiring polarity and phasing when terminating the CT leads to the EnergoM-3M1C. S1 connect to  $I_x^*$ , S2 connect to  $I_x$ .

The input network configuration of instrument depends on the CT number of the system:  
in the condition of 2 CT, select the three-phase, three-lines two components;  
in the condition of 3 CT, select the three-phase, four-lines three component mode.

Instrument connection mode, set of the instrument (programming input network NET) should be the same load wiring as measured wiring. Otherwise, the measurement instrument will lead to incorrect voltage or power.

#### **D. Auxiliary power**

Energom-3M1C with universal (AC / DC) power input, if not for a special statement, we provide the 90-240AC/DC power interface for standard products, please ensure that the auxiliary power can match with meter to prevent unexpected damage.

- A. Suggest install 1A fuse in the fire line side.
- B. For the areas with poor power quality, suggest install lightning surge suppressor and rapid burst suppressor to prevent lightning strikes.

### 3.2. - Connection Terminal

#### Upper connection terminal

16	15	14		13	12	11	10	9
UN				UA			I	I*

- 16. Neutral Voltage input*
- 13. Voltage A-phase input*

#### Lower connection terminal

8	7	6	5	4	3	2	1
RP-	RP+	485G	485B	485A		N	L

- 8.Active energy pulse output (-)*
- 7.Active energy pulse output (+)*

- 6. RS-485 (GND)*
- 5. RS-485 (-)*
- 4. RS-485 (+)*

#### **Note:**

The terminal pin definition may change depends on customer order; please refer to the label on the meter!

### 3.3. – Typical Wiring

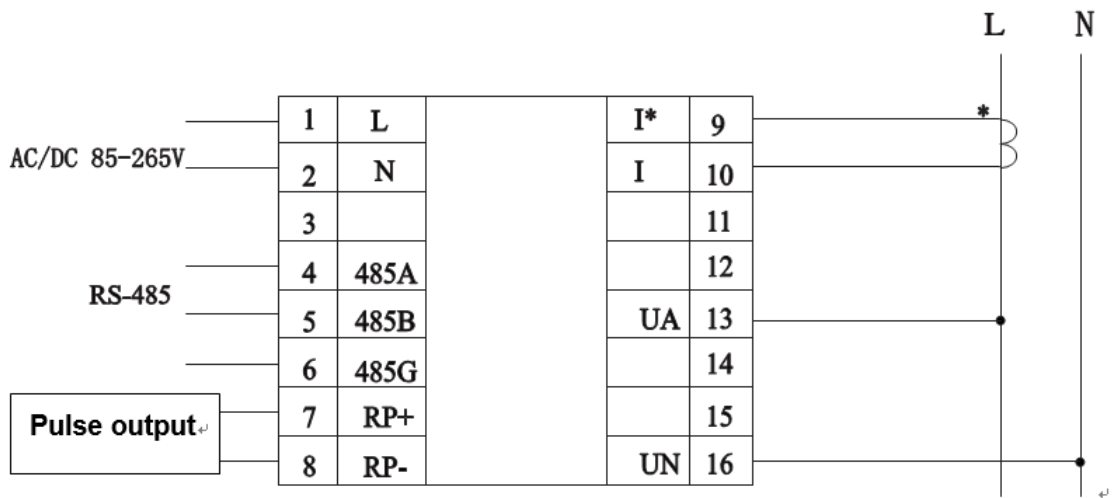

**Note:**

This connection drawing is for reference only; the actual connecting terminal please refer to the label on the rear part.

**WARNINGS!**

If power = -0.01 is shown for any of the phases and voltage and current are not zero for this phase, check out following points:

- Assure that A, B and C phases coincide in voltage and current.
- Correct polarity? Reverse the current transformer placed at this phase.

## 4. - SCREEN DISPLAY

### 4.1.- Screen description:

#### Panel & Screen introduction

- 1.- 7 digital show energy value
- 2.- Symbol for SUM energy record value
- 3.- Symbol for multi-tariff function
- 4.- Imp for energy consumption, Export for energy generate
- 5.- Symbol for Maximum demand
- 6.- Symbol for average value
- 7.- PF=power factory; Hz=Frequency
- 8.- Pulse output channel 1 and channel 2
- 9.-symbol for communication active
- 10.- symbol for timer
- 11.- symbol for screen locked

### 4.2.- Indicator light description:

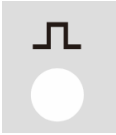
Name	Function definition(when lighting )
	Active power reverse
	Active energy pulse

### **4.3.- Screen pages' description:**

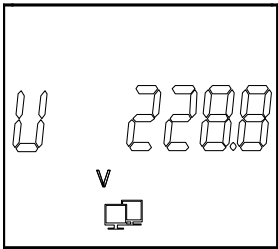
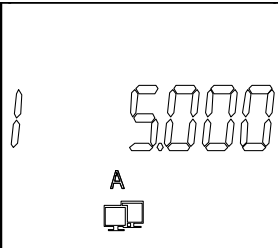
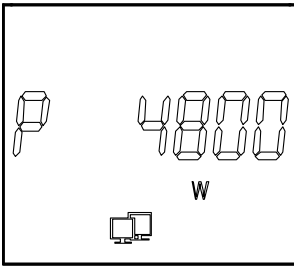
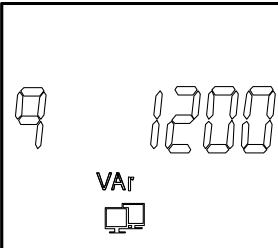
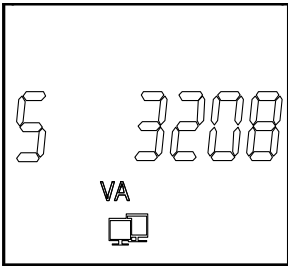
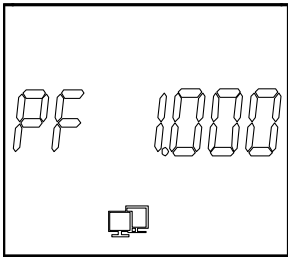
Screen No.	Screen interface	Description
1		Voltage: 228.8V
2		Current: 5.000A
3		Active power: 4800W
4		Reactive power: 1200Var
5		Apparent power: 3208VA
6		Power factor: 1.000

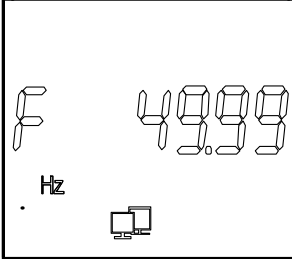
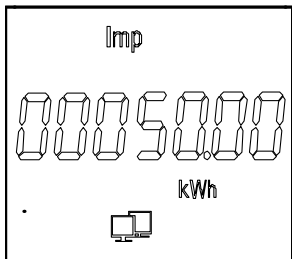
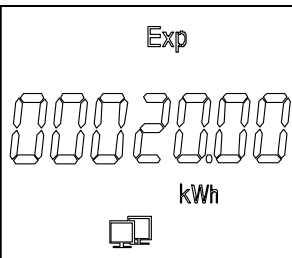
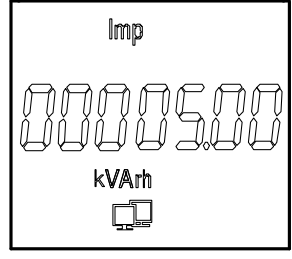
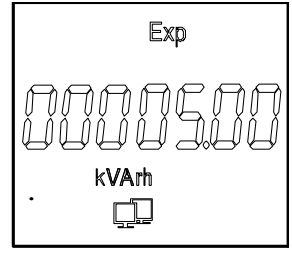
7	 <p>Digital display showing frequency: F 49.99 Hz. The display includes a small icon of a meter at the bottom.</p>	Frequency of grid: 49.99Hz
8	 <p>Digital display showing active power: Imp 00050.00 kWh. The display includes a small icon of a meter at the bottom.</p>	Active power: 50.00kwh
9	 <p>Digital display showing reactive power: Exp 00020.00 kWh. The display includes a small icon of a meter at the bottom.</p>	Reactive power: 20.00kwh
10	 <p>Digital display showing active reactive energy: Imp 00005.00 kVArh. The display includes a small icon of a meter at the bottom.</p>	Active reactive energy: 5.00kvarh
11	 <p>Digital display showing negative reactive energy: Exp 00005.00 kVArh. The display includes a small icon of a meter at the bottom.</p>	Negative reactive energy: 5.00kvarh



## 5. OPERATION MENU DESCRIPTION

### 5.1 Button description



**Short press** is the up button, turning the page to display the measurement data, displaying voltage, current, power, electric energy and other measurement data.

**Short press** is the down key, the function is the same as the up key, but the page turning direction is opposite;

**Long press** is the menu key to enter the programming menu, and it is also a function key to exit the menu step by step.

**Short press** is the confirmation key to confirm and save the entered information or displayed settings.

## 5.2 Main menu

In the case of measuring data, press the "menu" button, and the prompt of "PASS" (that is, "password") will appear, press the "OK" button to enter the user-level password (default is 0001), press the button to enter the programming in this state, the instrument provides three types of input setting menu items: system factory commissioning (SYS), input (-In-), and communication (bus). Adopt LCD display layered menu structure management.

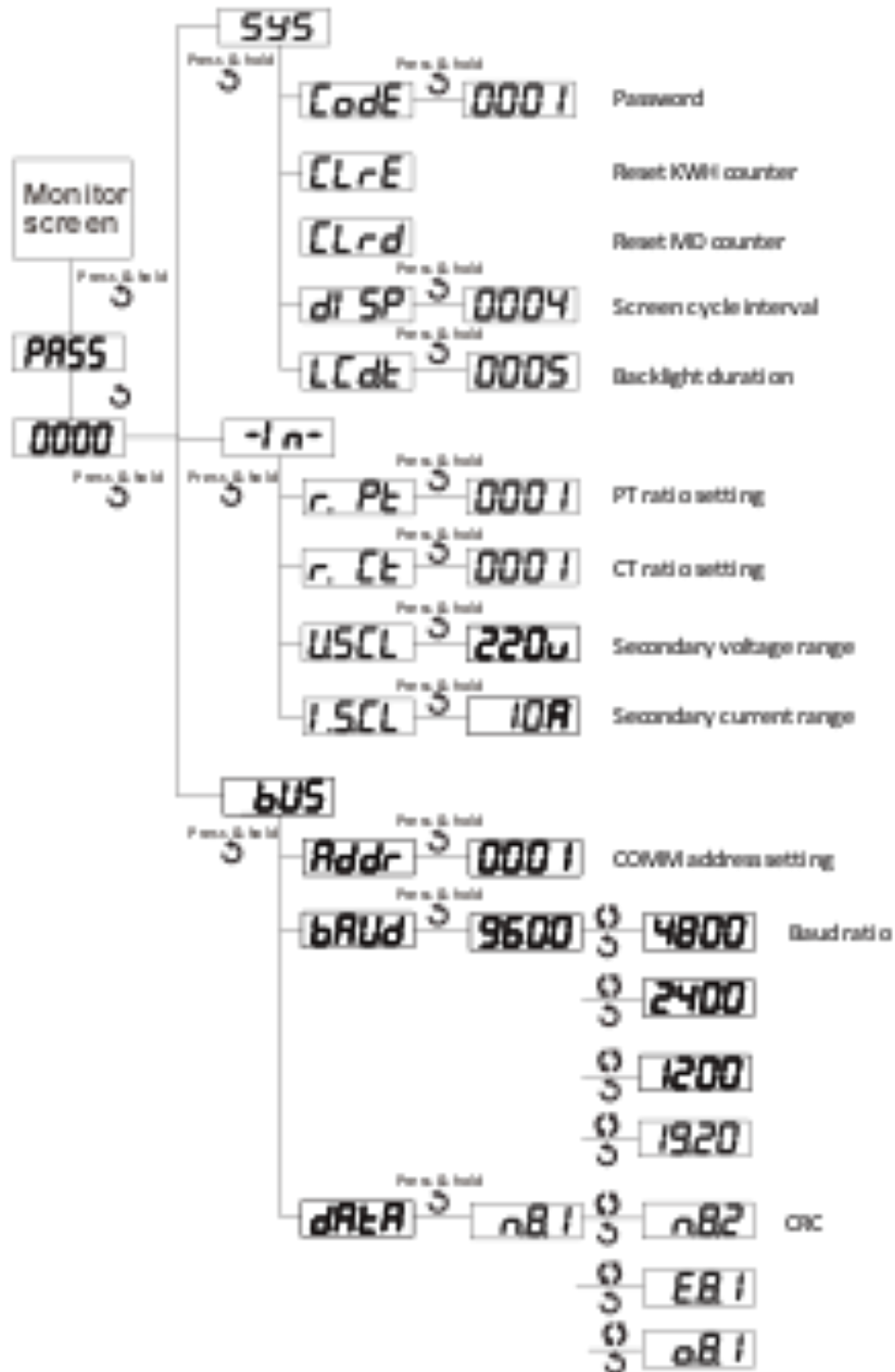

### 5.2.1 Description of menu characters:

<b>PASS</b>	(Password) User password
<b>Erro</b>	(Error) Wrong input information
<b>-I n-</b>	(Input) User Display Data Settings Menu
<b>bUS</b>	(Bus) Communication settings menu
<b>SYS</b>	(System) System settings menu (for factory debugging, not open yet)
<b>Code</b>	(Code) Enter password
<b>dAtA</b>	(Data) Communication parameter setting
<b>Addr</b>	(Address) Local communication address setting
<b>bAUd</b>	(Baud) Communication baud rate
<b>oB.1</b>	(o.8.1) Indicates 8 data bits, 1 stop bit, odd parity
<b>E.B.1</b>	(e.8.1) Indicates 8 data bits, 1 stop bit, even parity
<b>nB.1</b>	(n.8.1) Indicates 8 data bits, 1 stop bit, no parity bit
<b>USCL</b>	(U.scl) Select rated input voltage
<b>ISCL</b>	(I.scl) Select rated input current
<b>r. Ct</b>	(R.ct) Set the current multiplier
<b>r. Pt</b>	(R.pt) Set voltage ratio
<b>SYS</b>	(System) System settings menu (for factory debugging, not open yet)
<b>Code</b>	Modify password value

## 6.- PULSE OUTPUT (OPTIONAL)

Energom-3M1C provides 1\* pulse output for the active energy.

The host / PLC / DI module can cumulative the data of both the active and reactive power energy sent by the pulse from opt coupler relay.

1). Electrical specification: voltage  $VCC \leq 48V$ ,  $I_z \leq 50mA$ .

2). Pulse: 5000 imp / kWh, pulse up to 80ms.

This means: When the device detects 1 kWh, the port will generate 5000 pulse

### Note:

1 kWh energy is for secondary side energy data, if there have PT and CT accessed; primary side energy data is "1 kWh  $\times$ PT ratio $\times$  CT ratio".

Voltage (V)	Current (A)	Pulse constant (imp / kWh)
380 or 220	5	5000
	1	20000
100	5	20000
	1	80000

Example: In measure time "T", the received total pulse is "N",  
Primary side input of voltage is 10Kv  
Primary side input of current is 400A.  
Secondary side measurement range is 100V and 5A.

In the time "T", energy accumulated is:  $N / 20000 \times 100 \times 80$

## 7 - COMMUNICATION INTERFACE

### 7.1.- Connection for RS485 BUS

The composition of the RS-485 cabling must be carried out with a meshed screen cable (minimum 3 wire), diameter of not less than 0.5mm<sup>2</sup>, with a maximum distance of 1,200 m between the EnergoM-3M1C... and the master unit. This Bus may connect a maximum of 32pcs

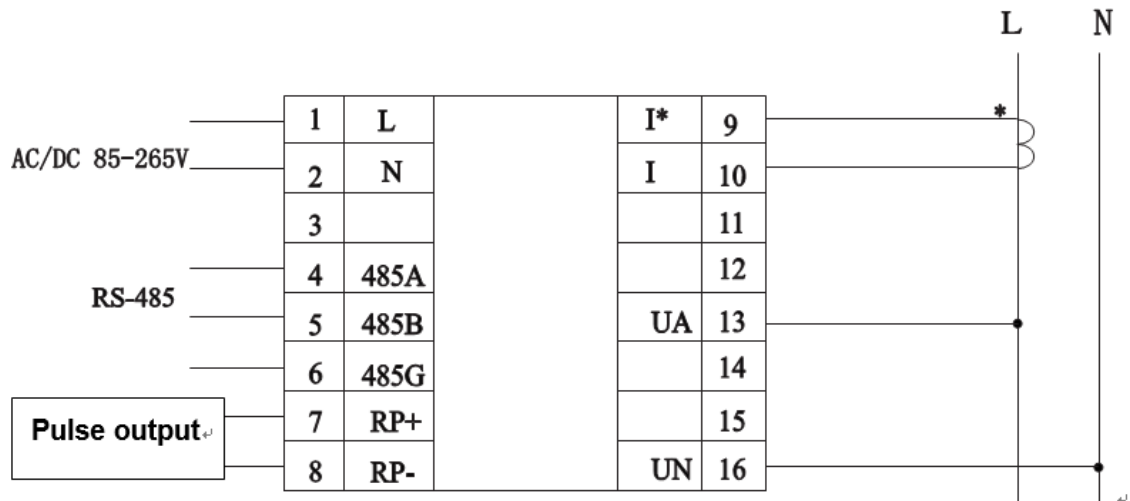

#### Notes:

- For communication with the master unit, user can choose RS-485 to RS-232 converter or RS485 to USB adapter to use.
- For expand the number of devices in the communication network, a signal repeater can be used.
- RS485 PIN number is 58,59,60
- Due to product modifications or special requirements, the interface pin place may be change. For details, please refer to product label on the rear side

## 7.2.- MODBUS © Protocol

### Modbus RTU Frame Format:

<b>Address code</b>	<b>1 BYTE</b>	<i>Slave device address 1-247</i>
<b>Function code</b>	<b>1 BYTE</b>	<i>Indicates the function codes like read coils / inputs</i>
<b>Data code</b>	<b>4 BYTE</b>	<i>Starting address, high byte Starting address, low byte Number of registers, high byte Number of registers, low byte</i>
<b>Error Check code</b>	<b>2 BYTE</b>	<i>Cyclical Redundancy Check (CRC)</i>

### MODBUS FUNCTIONS:

<b>Code</b>	<b>Meaning</b>	<b>Description</b>
<b>FUNCTION 01</b>	Read Coil Status	<i>Only valid when equipped DO port</i>
<b>FUNCTION 02</b>	Read Input Status	<i>Only valid when equipped DI port</i>
<b>FUNCTION 03</b>	Reading of n Words	<i>This function permits to read all the electrical parameters</i>
<b>FUNCTION 05</b>	Force Single coil	<i>When DO in remote control mode can work</i>
<b>FUNCTION 06</b>	Preset Single register	<b><i>Disable in default</i></b> <i>If need valid this code, please contact Energometrika Sales Team before your order!</i>

**Note:** Float data follow **IEEE754**, float low bit first, high bit next. **(CD AB)**

### 7.3.- Register Map

#### 7.3.1.- Basic power data—Primary Side

Register	Data	Byte mode		Instruction
0x00	U	float	2	Phase to Line Voltage, Unit: V
0x0c	I	float	2	Current, Unit: A
0x12	P	float	2	Active power, Unit: kw
0x1a	Q	float	2	Reactive power, Unit: kvar
0x22	S	float	2	Apparent power, Unit: kva
0x2a	PF	float	2	Power factor, 0~1.000
0x32	FR	float	2	Frequency, Unit:0.01Hz
0x34	Ep+	float	2	Positive active energy, Unit: kWh
0x36	Ep-	float	2	Negative active energy, Unit: kWh
0x38	Eq+	float	2	Inductive reactive power, Unit: kVarh
0x3a	Eq-	float	2	Capacitive reactive power

### 7.3.2.- Basic power data—Secondary Side

Register	Data	Byte mode		Instruction
0x100	Ua	int	1	Voltage, Unit: 0.1V Current, Unit:0.001 A
0x106	Ia	int	1	
0x109	Pa	int	1	Active power, Unit: W
0x10d	Qa	int	1	Reactive power, Unit: Var
0x111	Sa	int	1	Apparent power, Unit: Va
0x115	PFa	int	1	Power factor, 0~1.000
0x119	FR	int	1	Frequency, unit:0.01hz
0x11a	Ep+	int	2	Positive active energy, Unit: Wh
0x11c	Ep-	int	2	Negative active energy, Unit: Wh
0x11e	Eq+	int	2	Inductive reactive power, Unit: Varh
0x120	Eq-	int	2	Capacitive reactive power

#### Notes:

1. The data can be read out depends on your multi-function meter model, please refer to the corresponding product manual before build your software.
2. Some software has different definitions of the start bit of register address, there will be offset, please add 1 for the right address. To get more info, please contact technical support.



## 7.4.- Example

Host inquiry slave device

Addr.	Func.	Data Address high	Data Address low	Data Number high	Data number low	CRC16 low	CRC16 high
0CH	03H	00H	00H	00H	06H	C4H	D5H

**PC user ask upload UA, UB, UC, IA, IB, IC**

Slave device response

Addr.	Func.	Byte count	Data1 high	Data1 low	Data2 high	Data2 low	Data3 high	Data3 low
0CH	03H	0CH	03H	E8H	03H	E9H	03H	E8H
Data4 high	Data4 low	Data5 high	Data5 low	Data6 high	Data6 low	CRC16 low	CRC16 high	
13H	84H	13H	88H	13H	8AH	A6H	D6H	

**Show the data:**

UA=3E8H (100.0)  
 UB=3E9H (100.1)  
 UC=3E7H (99.9)  
 IA=1384H (4.996)  
 IB=1388H (5.000)  
 IC=138AH (5.002)

**Notes:**

1. Energometrika disable the 06 function in default setting, if Activated the write command, please check the host device program to avoid the meaningless write operation, that may reduce the register working life.
2. When the write is unsuccessful, no return data from the slave device. In this addition, please re-send write inquiry again.

## 8. - SAFETY CONSIDERATIONS



All installation specification described at the previous chapters named:  
**INSTALLATION AND STARTUP, INSTALLATION MODES and SPECIFICATIONS.**

Please note that with the instrument powered on, the terminals could be dangerous to touching and cover opening actions or elements removal may allow accessing dangerous parts. This instrument is factory-shipped at proper operation condition.

- ◆ The device must have a professional installation and maintenance
- ◆ Any operation of the device, you must cut off the input signal and power;

## 9. - MAINTENANCE

The EnergoM-3M1C single phase energy meter does not require any special maintenance. No adjustment, maintenance or repairing action should be done when the instrument is open and powered on, should those actions are essential, high-qualified operators must perform them.

Before any adjustment, replacement, maintenance or repairing operation is carried out, the instrument must be disconnected from any power supply source.

When any protection failure is suspected to exist, the instrument must be immediately put out of service. The instrument's design allows a quick replacement in case of any failure.

## 10. - TECHNICAL SERVICE

### FAQ's

- 1.- Once cabled and connected is seen to give a correct voltage and current reading, but shows negative values for active power (generation).

This is an error with the cabling for the current transformer secondary; the direction of the transformer current has to be respected as shown in the connection diagram. The current transformers have a two face primary; the current must pass from P1 to P2 giving the result in secondary (S1 and S2) of 5 amps.

The error stems from:

- a). The current transformers have been incorrectly installed. As a result, it gives the direction of the current as passing from P2 to P1; to resolve this problem, the current transformer does not have to be dismantled and installed again, but the transformer secondary (S1 and S2) just has to be inverted.
  - b). The connection of the current secondary in the current transformers have been incorrectly connected; to resolve this problem just connect the S1 transformer secondary to the S1 on the meter and the S2 on the current transformer to the S2 on the meter.
- 2.- Once cabled and connected, is seen to give an incoherent Power factor and  $\text{Cos}\Phi$  reading (-0.01 or similar).

This is again a current transformer and voltage phase connection error phase A, must correspond to the current transformer installed in phase A; phase B, must correspond to the current transformer installed in phase B; and phase C, must correspond to the current transformer installed in phase C.

This connection terminal is clearly shown on the area side of the device.

- 3.- The measuring voltage and is displaying the secondary voltage (for example 110 volts). Ensure that the voltage Transformer ratio has been correctly set.
- 4.- Device does not correctly display the current reading. It shows values varying between 0 to 5 amps of current. Ensure that the Current Transformer ratio has been correctly set.

## Calculation formula of electrical parameter

Formula	Parameter
$U = \sqrt{\frac{1}{N} \sum_{n=0}^N u_n^2} \quad n = 0, 1, 2, \dots, N$	Voltage RMS value
$I = \sqrt{\frac{1}{N} \sum_{n=0}^N i_n^2} \quad n = 0, 1, 2, \dots, N$	Current RMS value
$P = \frac{1}{N} \sum_{n=1}^N (i_{an} u_{an} + i_{bn} u_{bn} + i_{cn} u_{cn})$	Total active power cycle average
$P_s = UI$	Single-phase apparent power cycle average
$\cos\theta = \frac{P_p}{P_s}$	Power factor
$P_q = \sqrt{P_s^2 - P_p^2}$	Reactive power (Pq is positive and the direction cannot be determined; P algorithm can be used to shift the voltage component by 90°)
$W = \int P^* dt$	Electric energy

**Note:** In above formula, N for sampling points in one AC wave.